

TECHNICAL MANUAL

**ORGANIZATIONAL, DIRECT SUPPORT, AND
GENERAL SUPPORT MAINTENANCE
REPAIR PARTS AND SPECIAL TOOLS LISTS
(INCLUDING DEPOT MAINTENANCE REPAIR PARTS AND SPECIAL TOOLS)**

FOR

**COMMUNICATIONS CENTRAL AN/TSC-25 LESS POWER
(NSN 5895-00-167-8010)**

TECHNICAL MANUAL }
 No. 11-5895-288-24(Para }

HEADQUARTERS
 DEPARTMENT OF THE ARMY
 WASHINGTON, DC, 30 December 1978

**ORGANIZATIONAL, DIRECT SUPPORT, AND GENERAL SUPPORT MAINTENANCE
 REPAIR PARTS AND SPECIAL TOOLS LISTS
 (INCLUDING DEPOT MAINTENANCE REPAIR PARTS AND SPECIAL TOOLS)
 FOR
 COMMUNICATIONS CENTRAL AN/TSC-25 LESS POWER
 (NSN 5895-00-167-8010)
 Current as of 30 May 1978**

REPORTING OF ERRORS

You can improve this manual by recommending improvements using DA Form 2028-2 located in the back of the manual. Simply tear out the self-addressed form, fill it out as shown on the sample, fold it where shown, and drop it in the mail.

If there are blank DA Forms 2028-2 in the back of your manual, use the standard DA Form 2028 (Recommended Changes to Publications and Blank Forms) and forward to the Commander, US Army Communications and Electronics Material Readiness Command, ATTN: DRSEL-MA-Q, Fort Monmouth, NJ 07703.

In either case a reply will be furnished direct to you.

Table of Contents

		Page	Illus. Figure
SECTION	I. Introduction	1	
	II. Repair parts list	5	
Group	00 Communications Central AN/TSC-25 Less Power	5	1
	01 Antenna style	6	2
	0101 Mast, antenna	6	3
	02 Shelter, electrical equipment	7	4
	0201 Box, signal entrance	8	5
	0202 Box, power entrance	8	6
	0203 Box, HF transmitting entrance	8	7
	0204 Box, HF receiving entrance	9	8
	0205 Dolly set, lift, transportable shelter	9	9
	03 Equipment rack 402 (transmitting) Cabinet, Electrical		
	Equipment CY-3579/PRT-52A (see figure 1 for breakdown)		
	0301 Power Supply Amplifier AN/URA-36A (see figure 1 for breakdown)	9	10
	0302 Control, Transmitter C-9893/TSC-25	9	11
	0303 Oscillator, Radio Frequency -1706/TSC-25	9	12
	030301 Exciter, Multimode BMA-106	9	13
	03030101 Circuit card, carrier generator Z109	11	14
	03030102 Circuit card, comb filter A Z102	12	15
	03030103 Circuit card, comb filter B Z10	13	16
	03030104 Circuit card, frequency shift generator Z108	15	17
	03030105 Circuit card, mixer divider Z105	16	18
	03030106 Circuit card, mixer divider Z106	18	19
	03030107 Circuit card, mixer divider Z104	20	20
	03030108 Circuit card, radio frequency output Z115	21	21
	03030109 Circuit card, riser	21	22
	03030110 Circuit card, sideband generator Z107	23	23
	03030111 Circuit card, spectrum generator Z101	24	24
	03030112 Circuit card, step generator Z110	26	25
	03030113 Circuit card, step generator B Z111		

* This manual supersedes TM 11-5895-288-35P/2, 29 April 1969 and so much of TM 11-5895-288-20P, 6 August 1963 as pertains to the AN/TSC-25.

		page	Illustr.
	03030114	Circuit card, step generator C Z113	27 26
	03030115	Circuit card, translator assembly Z112	29 27
	0303011501	Circuit card, 120 MHz generator.....	32 28
	03030116	Exciter, multimode, subassembly AA2	33 20
	0303011601	Power supply	35
	030301160101	Circuit card A Z304.....	36
	030301160102	Circuit card B Z303.....	36 32
	030301160103	Ovensized oscillator Z302 (see figure 30 for breakdown)	
	030301160104	Ovensized oscillator Z301 (see figure 30 for breakdown)	
	030301160105	Power supply assembly (see figure 30 for breakdown)	
	030301160106	Circuit card, riser	37 33
	0304	Power Distribution Panel SB-1577/FRT (see figure 1 for breakdown)	
	0305	Fan, axial muffin type	37 34
	0306	Exhaust duct.....	37 35
04	Equipment rack 403A1	(test and env) (see figure 1 for breakdown)	
	0401	Standing Wave Ratio Indicator IM-166/URT (less cover) (see figure 1 for breakdown)	
	0402	Panel, patch, antenna	38 36
	0403	Decibel Meter ME-22A/PCM (less cover) (see figure 1 for breakdown)	
	0404	Signal Generator SG-15A/PCM less cover) (see figure 1 for breakdown)	
	0405	Air conditioner (see figure 1 for breakdown)	
05	Equipment rack 403A2	(aural comm) (see figure 1 for breakdown)	
	0501	Panel, line battery supply No. 1 NRC type 227	38 37
	0502	Red patch panel	39 38
	0503	Alarm unit	39 39
	0504	Telephone Sets Nos. 1 and 2 TA-43/PT (less CY-1277/PT) (see figure 1 for breakdown)	
	0505	Telephone Set TA-312/PT (less cover) (see figure 1 for breakdown)	
	0506	Clock	39 40
	0507	Spotlight	39 41
	0508	Local battery loop control No. 3.....	39 42
06	Equipment rack 404	(secure comm) (see figure 1 for breakdown)	
	0601	Communication Security Equipment TSEC/KW-7 Nos. 1, 2, 3, and 4 (see figure 1 for breakdown)	
	0602	Fixed Plant Adapter Units Nos. 1 and 2 KWX-11/TSEC (see figure 1 for breakdown)	
	0603	Power supply, red/black	40 43
07	Equipment rack 405A1	CITY comm) (see figure 1 for breakdown)	
	0701	Panel, patch, secure No, 1	40 44
	0702	Teletypewriter Set AN/FGC-161X (less FN-65/FG) (see figure 1 for breakdown)	
	0703	Box, low level interface No. 1	40 45
08	Equipment rack 405A2	(TTY and telephone comm) (see figure 1 for breakdown)	
	0801	Panel, current limiter	41 46
	0802	Patch panel	41 47
	0803	Telephone Nos. 1 and 2 Terminal AN/FTA-28 (see figure 1 for breakdown)	
	0804	Secure Nos. 1 and 2 panel (see figure 44 for breakdown)	
	0805	Teletypewriter Set AN/FGC-161X (less FN-65/FG) (see figure 1 for breakdown)	
	0806	Low level interface No. 2 box (see figure 45 for breakdown)	
09	Equipment rack 406	(receiving) (see figure 1 for breakdown)	
	0901	Panel, dual speaker and amplifier, type 414A	41 48
	0902	Panel, multiple repeat.....	42 49
	0903	Receiver, Radio R-1981/TSC-25.....	42 50
	090301	Receiver assembly A1	42 50
	09030101	Audio assembly A1A2	43 51
	09030102	Amplifier subassembly AA3.....	44 52
	0903010201	Intermediate frequency amplifier A1A3A4	46 53,54,55
	09030103	Radio frequency amplifier A1A7	48 56
	09030104	Oscillator assembly A1A8	51 57
	09030105	Gear assembly A1A9	52
	09030106	Power supply A 1A5	56
	09030107	Radio frequency oscillator A1A6	56 60
	09030108	Front panel assembly A1A34	56 61
	09030109	Panel assembly A1A37	7 62,63
	0904	Compensator, Frequency CN-1448/TSC-25	58
	090401	Main chassis assembly	58
	090402	Circuit card, divider Z104	59 66
	090403	Circuit card, first mixer Z101	60 67
	090404	Circuit card, fourth mixer Z103.....	61 68

	Page	Illus Figure
090405	Circuit card, multiplier Z108	62 69
090406	Circuit card, phase detector Z109	63 70
090407	Circuit card, power supply Z105	64 71
090408	Circuit card, second mixer Z107	64 72
090409	Circuit card, spectrum generator Z102	65 73
090410	Circuit card, third mixer Z106	67 74
090411	Front panel assembly (see figure 65 for breakdown)	
09041101	Oscillator relay circuit card Z110 (see figure 65 for breakdown)	
090412	Rear panel assembly (see figure 65 for breakdown)	
0905	Converter, Single-Double Sideband CV-3300/TSC-25	68 75
090501	RF Cable Assembly CG-409E/U (see figure 75 for breakdown)	
090502	AGC cable assembly SMB180489 (see figure 75 for breakdown)	
090503	Electrical power cable CD370 (see figure 75 for breakdown)	
090504	Electrical power cable (see figure 75 for breakdown)	
090505	Cover assembly SMB180495 (see figure 75 for breakdown)	
09050501	Axial fan SMC180502 (see figure 84 for breakdown)	
090506	Frame assembly SMD180170 (see figure 76 for breakdown)	
09050601	Power chassis assembly SMD180183 (see figure 82 for breakdown)	
0905060101	Terminal board assembly SMB180188 (see figure 82 for breakdown)	
09050602	Panel assembly chassis SMD180282 (mod) (see figure 76 for breakdown)	
0905060201	RF chassis assembly SMD180343	69 76thru 84
090506020101	Terminal board SMC180395 (see figure 77 for breakdown)	
090506020102	Terminal board SMC180393 (see figure 77 for breakdown)	
090506020103	Terminal board SMC180401 (see figure 77 for breakdown)	
090506020104	Terminal board SMB180404 (see figure 77 for breakdown)	
090506020105	Terminal board SMB180407 (see figure 77 for breakdown)	
090506020106	Terminal board SMC180409 (see figure 77 for breakdown)	
090506020107	Terminal board SMC180412 (see figure 77 for breakdown)	
090506020108	Terminal board SMC180415 (see figure 77 for breakdown)	
090506020109	Terminal board SMB180418 (see figure 77 for breakdown)	
090506020110	Terminal board SMB180421 (see figure 77 for breakdown)	
090506020111	Terminal board SMB180424 (see figure 77 for breakdown)	
090506020112	Terminal board SMC180427 (see figure 77 for breakdown)	
090506020113	Terminal board SMB180430 (see figure 77 for breakdown)	
090506020114	Terminal board SMC180433 (see figure 77 for breakdown)	
090506020115	Terminal board SMC180436 (see figure 77 for breakdown)	
090506020116	Terminal board SMC180439 (see figure 77 for breakdown)	
090506020117	Terminal board SMB180442 (see figure 77 for breakdown)	
090506020118	Terminal board SMB180445 (see figure 77 for breakdown)	
090506020119	Terminal board SMC180448 (see figure 77 for breakdown)	
090506020120	Terminal board SMB180451 (see figure 77 for breakdown)	
090506020121	Terminal board SMC180454 (see figure 77 for breakdown)	
090506020122	Terminal board SMB180457 (see figure 77 for breakdown)	
0905060202	Oscillator cover assembly SMC180291 (see figure 83 for breakdown)	
0905060203	Crystal oven assembly BG20073EX100KC (mod) (see figure 76 for breakdown)	
0905060204	Control panel assembly SMD180300 (see figure 75 for breakdown)	
090506020401	AFC unit assembly SMD180327	80 85, 86
090506020402	Vernier drive assembly SMD180310 (see figures 75, 76, 77, and 79 for breakdown)	
09050603	Power supply subassembly SMD180201 (see figure 75, 76, and 80 for breakdown)	
0905060301	Terminal board SMB180225 (see figures 75, 76, 80, 81, 82, and 83 for breakdown)	
0905060302	Terminal board SMB180228 (see figures 80 and 81 for breakdown)	
0905060303	Terminal board SMB180231 (see figure 80 for breakdown)	
0905060304	Terminal board SMB180234 (see figure 80 for breakdown)	
0905060305	Terminal board SMB180237 (see figure 80 for breakdown)	
0905060306	Terminal board SMB180240 (see figures 80, 81, 83, and 84 for breakdown)	
090507	Modification, 100 & 500 kHz oscillators	81 87, 88
0906	Local battery loop control No. I (see figure 42 for breakdown)	
10	Equipment rack 407 (mux-demux) (see figure I for breakdown)	
1001	Panel, volume and current level indicator	81 89
1002	lack patch panel	81 90
1003	Audio-dc patch panel	81 91
1004	Tone keyer shelf, type 221, model 1	82 92
100401	Automatic Power Supply Selector Control C-4107/GGA (see TM 11-5805-342-14P for listing of parts)	
100402	Extension adapter AI, 750 and 751	82 93

		Page	Illus Figure
100403	Power Supply PP-3352/GGA (see TM 11-5805-342-14P for listing of parts)		
100404	Telephone line isolation unit Z1.....	83	94
100405	Frequency shift tone keyers, type 211, model 2.....	83	95
10040501	Frequency determining networks NRC211 1Z4, 5, 6, 7, 12, 13, 14, 15 model 2 (see figure 95 for breakdown)		
1005	Combined function panel.....	84	96
1006	Audio patch panel.....	84	97
1007	Tone converter shelf No. 1, type 222, model 5.....	84	98
100701	Telephone line isolation unit Z1 (see figure 94 for breakdown)		
100702	Power Supply PP-3352/GGA (see TM 11-5805-342-14P for listing of parts)		
100703	Automatic Power Supply Selector Control C-4107/GGA (see TM 11-5805-342-14P for listing of parts)		
100704	Diversity combiner, type 234, model 2.....	85	99
100705	Dotter and delay indicator.....	86	100
100706	Frequency shift tone converter, type 212, model 3.....	87	101
10070601	Relay assembly, type 692A.....	88	102
10070602	Frequency determining and delay network, type NRC212-3ZD4, DI2.....	88	103
1008	Tone converter shelves Nos. 2 and 3, type 222, model 4.....	88	104
100801	Telephone line isolation unit Z3 (see figure 94 for breakdown)		
100802	Power Supply PP-3352/GGA (see TM 11-5805-342-14P for listing of parts)		
100803	Automatic Power Supply Selector Control C-4107/GGA (see TM 11-5805-342-14P for listing of parts)		
100804	Diversity combiner (see figure 99 for breakdown)		
100805	Frequency shift tone converters (see figure 101 for breakdown)		
10080501	Relay assembly 692A (see figure 102 for breakdown)		
10080502	Frequency determining and delay networks NRC212-3ZD5, 6, 7, 13, 14, 15 (see figure 103 For breakdown)		
1009	Demultiplexer Nos. 1 and 2 AN/GGA-13 (see TM 11-5805-342-14P for listing of parts)		
100901	Automatic Power Supply Selector Control C-4107/GGA (see TM 11-5805-342-14P for listing of parts)		
100902	Power Supply PP-3352/GGA (see TM 11-5805-342-14P for listing of parts)		
100903	Demultiplexer TD-557/GGA (see TM 11-5805-342-14P for listing of parts)		
10090301	Line amplifier subassembly AI (see TM 11-5805-342-14P for listing of parts)		
10090302	Supply modulator and carrier (see TM 11-5805-342-14P for listing of parts)		
1010	Multiplexer AN/GGA-12 (see TM 11-5805-342-14P for listing of parts)		
101001	Automatic Power Supply Selector Control C-4107/GGA (see TM 11-5805-342-14P for listing of parts)		
101002	Power Supply PP-3352/GGA (see TM 11-5805-342-14P for listing of parts)		
101003	Multiplexer TD-556/GGA, AI, A2 (see TM 11-5805-342-14P for listing of parts)		
10100301	Line amplifier subassembly (see TM 11-5805-342-14P for listing of parts)		
10100302	Supply modulator and carrier (see TM 11-5805-342-14P for listing of parts)		
10100303	Input coupler subassembly (see TM 11-5805-342-14P for listing of parts)		
1011	Line battery supply No. 2 panel (see figure 37 for breakdown)		
1012	Local battery loop control No. 2 (see figure 37 for breakdown)		
1013	Order wire hybrid.....	89	105
11	Equipment rack 408 (secure comm) (see figure 1 for breakdown)		
1101	Communication Security Equipment TSEC/KW-26 Nos. 1 and 2 (see figure 1 for break-down)		
1102	Cooling fan.....	89	106
1103	Installation kit for TSEC/KW-26.....	90	107
12	Test equipment.....	90	107.1
1201	Frequency Meter FR-114/U (see TM 11-6625-218-20P and TM 11-6625-218-40P for listing of parts)		
1202	Multimeter ME-26()/U (see TM 11-6625-200-24P for listing of parts)		
1203	Multimeter TS-352B/U (see TM 11-6625-366-24P for listing of parts)		
1204	Oscilloscope OS-8()/U (see TM 11-6625-252-20P and TM 11-6625-252-34P for listing of parts)		
1205	Test Set TS-2/TG (see TM 11-6625-254-25P for listing of parts)		
1206	Teletypewriter Test Set TS-1060()/GG (see TM 11-6625-207-20P and TM 11-6625-207-35for listing of parts)		
1207	Transistor Test Set TS-1100/U (see TM 11-6625-343-12P and TM 11-6625-343-35P for listing of parts)		
1208	Relay Test Set TS-1 194/U (see TM 11-6625-362-20P and TM 11-6625-362-34P for listing of parts)		
1209	Transistor Test Set TS- 1836/U (see TM 11-6625-539-20P and TM 11 -6625-539-40P for listing of pans)		

		Page	Illus Figure
	1210 Electron Tube Test Set TV-7D/U (see TM 11-6625-274-25P for listing of parts)		
13	Miscellaneous		
	1301 Panel, power control	91	108
	1302 IDF/MDF box	9	91
	109		
	1303 Transfer switch	91	109.1
	1304 Microphone Headset H-182/PT (see TM 11-5965-283-15 for listing of parts)		
	1305 Dummy Load DA-314/U	91	110
14	Trailer-Mounted Diesel Engine Generator Set PU-405A/U (no parts authorized)		
15	Cable assemblies		
	1501 Power cable	91	111
	1502 Cable, plug, electrical	91	112
	1503 Electrical power cable	92	113
	1504 Cord assembly	92	114
	1505 Cord assembly, electrical	92	114
	1506 Cable Assembly, Radio Frequency CG-409E/U	92	115
	1507 Special purpose cable assembly, automatic gain control (see figure 115 for breakdown)		
	1508 Cord assembly (see figure 115 for breakdown)		
	1509 Power cable assemblies	92	116
	1510 Terminal barrier, KW-7 rack	93	117
	1511 Radio Frequency Cable Assembly CG-1040B/U	93	118
	1512 loose cables and connectors	93	119
	1513 Patch cords, test leads and loose connectors	93	119
	1514 Power cable, coiled (see figure 115 for breakdown)		
	1515 Bulk cables	94	
SECTION III	Special tools list (Not applicable)		
IV.	National stock number and pan number index	292	

**SECTION I
INTRODUCTION**

1. Scope

This manual lists spares and repair parts; special tools; special test, measurement, and diagnostic equipment (TMDE), and other special support equipment required for performance of organizational, direct support, and general support maintenance of the AN/TSC-25. It authorizes the requisitioning and issue of spares and repair parts as indicated by the source and maintenance codes.

2. General

This Repair Parts and Special Tools List is divided into the following sections:

a. *Section II. Repair Parts List.* A list of spares and repair parts authorized for use in the performance of maintenance. The list also includes parts which must be removed for replacement of the authorized parts. Parts lists are composed of functional groups in numeric sequence, with the parts in each group listed in figure and item number sequence. Bulk materials are listed in NSN sequence.

b. *Section III. Special Tools List.* Not applicable.

c. *Section IV. National Stock Number and Part Number Index.* A list, in ascending numerical sequence, of all National stock numbers (NSN) appearing in the listings, followed by a list, in alphanumeric sequence, of all part numbers appearing in the listings. National stock numbers and part numbers are cross-referenced to each illustration figure and item number appearance.

3. Explanation of Columns

a. *Illustration.* This column is divided as follows:

(1) *Figure number.* Indicates the figure number of the illustration on which the item is shown.

(2) *Item number.* The number used to identify item called out in the illustration.

b. *Source, Maintenance, and Recoverability (SMR) Codes.*

(1) *Source code.* Source codes indicate the manner of acquiring support items for maintenance, repair, or overhaul of end items. Source codes are entered in the first and second positions of the Uniform SMR Code format as follows:

<i>Code</i>	<i>Definition</i>
PA -	Item procured and stocked for anticipated or known usage.
B -	Item procured and stocked for insurance purpose because essentially dictates that a minimum quantity be available in the supply system.
PD -	Support item, excluding support equipment, procured for initial issue or outfitting and stocked only for subsequent or additional initial issues or outfitting. Not subject to automatic replenishment.

<i>Code</i>	<i>Definition</i>
PF-	Support equipment which will not be stocked but which will be centrally procured on demand.
XA-	Item is not procured or stocked because the requirements for the item will result in the replacement of the next higher assembly.
XB-	Item is not procured or stocked. If not available through salvage, requisition.
XD-	A support item that is not stocked. When required, item will be procured through normal supply channels.

NOTE

Cannibalization or salvage may be used as a source of supply for any items source coded above except those coded XA and aircraft support items as restricted by AR 700-42.

(2) *Maintenance code.* Maintenance codes are assigned to indicate the levels of maintenance authorized to USE and REPAIR support items. The maintenance codes are entered in the third and fourth positions of the Uniform SMR Code format as follows:

(a) The maintenance code entered in the third position will indicate the lowest maintenance level authorized to remove, replace, and use the support item. The maintenance code entered in the third position will indicate one of the following levels of maintenance:

<i>Code</i>	<i>Application/Explanation</i>
O -	Support item is removed, replaced, used at the organizational level.
F -	Support item is removed, replaced, used at the direct support level.
H -	Support item is removed, replaced used at the general support level.
D -	Support items that are removed, replaced, used at depot, mobile depot, specialized repair activity only.

(b) The maintenance code entered in the fourth position indicates whether the item is to be repaired and identifies the lowest maintenance level with the capability to perform complete repair (i.e., all authorized maintenance functions). This position will contain one of the following maintenance codes:

<i>Code</i>	<i>Application/Explanation</i>
F -	The lowest maintenance level capable of complete repair of the support item is the direct support level.
H -	The lowest maintenance level capable of complete repair of the support item is the general support level.
D -	The lowest maintenance level capable of complete repair of the support item is the depot level.
Z -	Nonreparable. No repair is authorized.

(3) *Recoverability code.* Recoverability codes are assigned to support items to indicate the disposition action on unserviceable items. The recoverability code is entered in the fifth position of the Uniform SMR Code format as follows:

<i>Recoverability codes</i>	<i>Definition</i>
Z -	Nonreparable item. When unserviceable, condemn and dispose at the level indicated in position 3.
F -	Reparable item. When uneconomically reparable, condemn and dispose at the direct support level.
D -	Reparable item. When beyond lower level repair capability, return to depot. Condemnation and disposal not authorized below depot level.

c. *National Stock Number.* Indicates the National stock number assigned to the item and will be used for requisitioning purposes.

d. *Part Number.* Indicates the primary number used by the manufacturer (individual, company, firm, corporation, or Government activity) which controls the design and characteristics of the item by means of its engineering drawings, specifications, standards, and inspection requirements to identify an item or range of items.

NOTE

When a stock-numbered item is requisitioned, the repair part received may have a different part number than the part being replaced.

e. *Federal Supply Code for Manufacturer (FSCM).* The FSCM is a 5-digit numeric code listed in SB 708-42 which is used to identify the manufacturer, distributor, or Government agency, etc.

f. *Description.* Indicates the Federal item name and, if required, a minimum description to identify the item.

g. *Unit of Measure (U/M).* Indicates the standard of the basic quantity of the listed item as used in performing the actual maintenance function. This measure is expressed by a two-character alphabetical abbreviation (e.g., ea, in, pr, etc). When the unit of measure differs from the unit of issue, the lowest unit of issue that will satisfy the required units of measure will be requisitioned.

h. *Quantity Incorporated in Unit.* Indicates the quantity of the item used in the breakout shown on the illustration figure, which is prepared for a functional group, subfunctional group, or an assembly.

4. Special Information

a. The following publications pertain to the AN/TSC-25 and its components:

- TM 9-2330-275-14, Dolly Set, Lift, Transportable Shelter: M689, Dolly Set, Lift, Transportable Shelter: XM840 (Formerly XM689E1), and Dolly Set, Lift, Transportable Shelter: XM829
- TM 11-2208, Test Sets TS-2/TG, TS-2A/TG, TS-2B/TG, and TS-2C/TG (Teletypewriter Signal Distortion)
- TM 11-5515E, Generator Set, Signal (RF) AN/URM-25F

- TM 11-5805-201-20P, Telephone Set TA-312/PT
- TM 11-5805-201-34P, Telephone Set TA-312/PT
- TM 11-5805-256-24P, Telephone Set TA-43/PT
- TM 11-5805-342-14P, Multiplexer Group AN/GGA-12 and Demultiplexer Group AN/GGA-13
- (C)TM 11-5810-214-15, Communications Security Equipment TSEC/KW-26(U)
- TM 11-5810-221-12P, Communications Security Equipment TSEC/KW-7, TSEC/KW-7 with KWX-10/TSEC
- TM 11-5810-221-34P, Communications Security Equipment TSEC/KW-7
- TM 11-5810-251-14P, Communications Security Equipment TSEC/KW-26C
- TM 11-5815-244-12, Teletypewriter Sets AN/FGC-25, AN/FGC-25X, AN/FGC-26, AN/FGC-26X, AN/FGC-52, AN/FGC-52X, AN/FGC-57, AN/FGC-68, AN/FGC-161, AN/FGC-162, AN/UGC-30, and AN/UGC-30X
- TM 11-5815-244-34, Teletypewriter Sets AN/FGC-25, AN/FGC-25X, AN/FGC-26, AN/FGC-26X, AN/FGC-52, AN/FGC-52X, AN/FGC-57, AN/FGC-68, AN/FGC-161, AN/FGC-162, AN/UGC-30, and AN/UGC-30X
- TM 11-5815-244-20P, Teletypewriter Set: AN/FGC-25 and AN/FGC-25X
- TM 11-5815-244-34P, Teletypewriter Set AN/FGC-25; Teletypewriter Sets AN/FGC-25, AN/FGC-25X, AN/FGC-161 and AN/FGC-161X and Modification Kit MK-I 632/FGC
- TM 11-5820-359-12P, Power Supply PP-621/URR
- TM 11-5820-359-35P, Power Supply PP-621/URR
- TM 11-5820-472-12, Transmitting Set, Radio AN/FRT-53A
- TM 11-5820-472-20P, Transmitting Set, Radio AN/FRT-53A
- TM 11-5820-472-34P, Transmitting Set, Radio AN/FRT-53A
- TM 11-5820-481-14P, Panels, Power Distribution SB-1574/FRT and SB-1577/FRT
- TM 11-5820-481-35, Panel, Power Distribution SB-1574/FRT and Panel, Power Distribution SB-i 577/FRT
- TM 11-5820-482-12P, Amplifier-Power Supply Group AN/URA-36A
- TM 11-5820-482-35, Amplifier-Power Supply Group AN/URA-36A
- TM 11-5820-482-35P, Amplifier-Power Supply Group AN/URA-36A
- TM 11-5895-288-12/1, Communications Central AN/TSC-25
- TM 11-5895-288-20P, Communications Central

AN/TSC-20, AN/TSC-20A, and AN/TSC-25
 TM 11-5895-288-35, Communications Central
 AN/TSC-20, AN/TSC-20A, and AN/TSC-25
 TM 11-5895-344-14P, Mast AB-746/G
 TM 11-5895-283-15, Headset-Microphone H-182/PT
 TM 11-6625-200-15, Multimeters ME-26A/U, ME-
 26B/U, ME-26C/U, and ME-26D/U
 TM 11-6625-200-24P, Multimeters ME-26A/U, ME-
 26B/U, ME-26C/U, ME-26D/U
 TM 11-6625-207-10, Teletypewriter Test Sets TS-
 1060/GG, TS-1060A/GG, and TS-1060B/GG
 TM 11-6625-207-20, Teletypewriter Test Sets TS-
 1060/GG, TS-1060A/GG, and TS-1060B/GG
 TM 11-6625-207-20P, Test Sets, Teletypewriter TS-
 1060/GG, TS-1060A/GG, and TS-1060B/GG
 TM 11-6625-207-35, Teletypewriter Test Sets TS-
 1060/GG, TS-1060A/GG, and TS-1060B/GG
 TM 11-6625-218-12, Frequency Meter AN/TSM-16
 TM 11-6625-218-20P, Frequency Meter AN/TSM-16
 TM 11-6625-218-35, Frequency Meter AN/TSM-16
 TM 11-6625-218-40P, Frequency Meter AN/TSM-16
 TM 11-6625-239-12, Electronic Multimeters TS-
 505A/U and TS-505B/U and Multimeters TS-
 505C/U and TS-505D/U
 TM 11-6625-239-20P, Electronic Multimeters TS-
 505A/U and TS-505B/U and Multimeters TS-
 505C/U and TS-505D/U
 TM 11-6625-239-34P, Electronic Multimeters TS-
 505A/U and TS-505B/U and Multimeters TS-
 505C/U and TS-505D/U
 TM 11-6625-239-35, Electronic Multimeters TS-
 505A/U and TS-505B/U and Multimeters TS-
 505C/U and TS-505D/U
 TM 11-6625-251-15, Test Set TS-140/PCM, Signal
 Generator SG-15/PCM and SG-15A/PCM and
 Decibel Meters ME-22/PCM and ME-22A/PCM
 TM 11-6625-251-20P, Decibel Meters ME-22/PCM
 and ME-22A/PCM
 TM 11-6625-251-40P, Decibel Meters ME-22/PCM
 and ME-22A/PCM
 TM 11-6625-252-15, Oscilloscopes OS-8B/U, OS-
 8C/U, and OS-8E/U
 TM 11-6625-252-20P, Oscilloscopes OS-8B/U, OS-
 8C/U, and OS-8E/U
 TM 11-6625-252-34P, Oscilloscopes OS-8B/U, OS-
 8C/U, and OS-8E/U

TM 11-6625-254-25P, Test Sets, Teletypewriter TS-
 2/TG, TS-2A/TG, TS-2B/TG, and TS-2C/TG
 TM 11-6625-274-12, Test Sets, Electron Tube TV-
 7/U, TV-7A/U, TV-7B/U, and TV-7D/U
 TM 11-6625-274-25P, Test Sets, Electron Tube TV-
 7/U, TV-7A/U, TV-7B/U, and TV-7D/U
 TM 11-6625-274-35, Test Sets, Electron Tube TV-
 7/U, TV-7A/U, TV-7B/U, and TV-7D/U
 TM 11-6625-343-12P, Test Set, Transistor TS-1100/U
 TM 11-6625-343-35P, Test Set, Transistor TS-1100/U
 TM 11-6625-362-12, Test Set, Relay TS-1194A/U
 TM 11-6625-362-20P, Test Set, Relay TS-1194A/U
 TM 11-6625-362-35, Test Set, Relay TS-1194A/U
 TM 11-6625-362-34P, Test Set, Relay TS-1194A/U
 TM 11-6625-366-15, Multimeter TS-352B/U
 TM 11-6625-366-24P, Multimeter TS-352B/U
 TM 11-6625-504-12, Indicator, Standing Wave Ratio
 IM-166/URT
 TM 11-6625-504-20P, Indicator, Standing Wave Ratio
 IM-166/URT
 TM 11-6625-504-34P, Indicators, Standing Wave
 Ratio IM-166/URT
 TM 11-6625-504-35, Indicators, Standing Wave Ratio
 IM-166/URT
 TM 11-6625-539-15, Test Set, Transistor TS-1836/U
 TM 11-6625-539-20P, Test Set, Transistor TS-1836/U
 TM 11-6625-539-40P, Test Set, Transistor TS-1836/U

b. National stock numbers (NSN's) that are missing from P source coded items have been applied for and will be added to this TM by future change/revision when they are entered in the Army Master Data File (AMDF). Until the NSN's are established and published, submit exception requisitions to: Commander, US Army Communications and Electronics Materiel Readiness Command, ATTN: DRSEL-MM, Fort Monmouth, NJ 07703 for the part required to support your equipment.

5. How to Locate Repair Parts

a. When National stock number or part number is unknown.

(1) *First.* Using the table of contents, determine the functional group within which the item belongs. This is necessary since illustrations are prepared for functional groups and listings are divided into the same groups.

(2) *Second.* Find the illustration covering the functional group to which the item belongs.

(3) *Third.* Identify the item on the illustration and note the illustration figure and item number of the item.

(4) *Fourth.* Using the Repair Parts Listing, find the figure and item number noted on the illustration.

b. When National stock number or part number is known.

(1) First. Using the Index of National Stock Numbers and Part Numbers, find the pertinent National stock number or part number. This index is in ascending NSN sequence followed by a list of part numbers in ascending alphanumeric sequence, cross-referenced to the illustration

figure number and item number.

(2) *Second.* After finding the figure and item number, locate the figure and item number in the repair parts list.

6. Abbreviations

Not applicable.

(Next printed page is 5)

SECTION II REPAIR PARTS LIST

(1) ILLUSTRATION		(2)	(3)	(4)	(5)	(6)	(7)	(8)
(a) FIG NO.	(b) ITEM NO.	SMR CODE	NATIONAL STOCK NUMBER	PART NUMBER	FSCM	DESCRIPTION USABLE ON CODE	U/M	QTY INC IN UNIT
						GROUP 00 COMMUNICATIONS CENTRAL AN/TSC-25 LESS POWER NOTE COMMUNICATIONS CENTRAL AN/TSC-25 IS A VEHICULAR AND AIR-TRANSPORTABLE 1- KILOWATT /KW/ INDEPENDENT SIDEBAND /ISB/ RADIO TELETYPEWRITER FACILITY. CAPABLE OF SIMULTANEOUS TRANSMISSION AND RECEPTION OF VOICE AND TELETYPEWRITER SIGNALS IN THE 2.0 TO 32.0 MEGAHERTZ /MHZ/ RANGE. THIS SYSTEM MAY BE AIR-TRANSPORTED BY TYPE C-123 AIRCRAFT.		
1	1	XDFFF		LBAD-D-12345	82679	EQUIPMENT RACK 402 /TRANSMITTING/ CABINETEA	1	
1	2	XDFFF		AN/URA-36A	82679	ELECTRICAL EQUIPMENT CY-35/9FRT-S3A		
1	3	XDFFF		58-1577/FRT	82679	AMPLIFIER. POWER SUPPLY	EA	1
1	4	XDFFF		LBAD-D-12354	82679	PANEL. POWER DISTRIBUTION	EA	1
1	5	XDFFF		IM166URT	82679	EQUIPMENT RACK 403A1	EA	1
1	6	XDFFF		ME22APCM	82679	STANDING WAVE RATIO INDICATOR	EA	1
1	7	XDFFF		SG15APCM	82679	DECIBEL METER.....	EA	1
1	8	XDFFF		LBAD-D-12346	82679	SIGNAL GENERATOR.....	EA	1
1	9	XDFFF		LBAD-D-12347	82679	AIR CONDITIONER.....	EA	1
1	10	XDFFF		TA43PT	82679	EQUIPMENT RACK 4A3A2.....	EA	1
1	11	XDFFF		TA312PT	82679	TELEPHONE SETS NO. 1 AND NO. 2	EA	1
1	12	XDFFF		LBAD-12348	82679	TELEPHONE SET	EA	1
1	13	XDFFF		TSECK7	82679	EQUIPMENT RACK 404	EA	1
1	14	XDFFF		KWX11TSEC	82679	COMMUNICATION SECURITY EQUIPMENTEA	4	
1	15	XDFFF		LBAD-D-12349	82679	FIXED PLANT ADAPTER UNITS NO. 1 AND NO. 2	EA	2
1	16	XDFFF		AN/FGC-161X	82679	EQUIPMENT RACK 405A1	EA	1
1	17	XDFFF		LBAD-D-12350	82679	TELETYPEWRITER SET AN/FGC-161X ...	EA	2
1	18	XDFFF		ANFTA28	82679	EQUIPMENT RACK 405A2	EA	1
1	19	XDFFF		LBAD-D-12351	82679	TERMINAL. TELEPHONE NO. 1 AND NO. 2	EA	2
1	20	XDFFF		LBAD-D-12352	82679	EQUIPMENT RACK 406	EA	1
1	21	XDFFF		LBAD-D-12353	82679	EQUIPMENT RACK 407	EA	1
1	22	XDFFF		TSEC/KW-26	82679	EQUIPMENT RACK 408	EA	1
1	23	XDFFF		FR114U	82679	COMMUNICATION SECURITY EQUIPMENTEA	2	
1	24	XDFFF		ME26U	82679	FREQUENCY METER.....	EA	1
1	25	XDFFF		TS352BU	82679	MULTIMETER	EA	1
1	26	XDFFF		OS8U	82679	MULTIMETER	EA	1
1	27	XDFFF		TS2TG	82679	OSCILLOSCOPE	EA	1
1	28	XDFFF		TS106DGG	82679	TEST SET, TELETYPEWRITER	EA	1
1	29	XDFFF		TS1100U	82679	TEST SET, TELETYPEWRITER	EA	1
1	30	XDFFF		TS1194U	82679	TEST SET, TRANSISTOR.....	EA	1
1	31	XDFFF		TS1836U	82679	TEST SET, RELAX.....	EA	1
					5			

SECTION II REPAIR PARTS LIST

(1) ILLUSTRATION		(2)	(3)	(4)	(5)	(6) DESCRIPTION	(7)	(8)
(a) FIG NO.	(b) ITEM NO.	SMR CODE	NATIONAL STOCK NUMBER	PART NUMBER	FSCM	USABLE ON CODE	U/M	QTY INC IN UNIT
1	32	XDFFF		TV7DU	82679	TEST SET. ELECTRON TUBE..... EA	1	
1	33	XDFFF		634D	U2389	TRANSFER SWITCH EA	1	
1	34	XDFFF		H-182/PT	82679	MICROPHONE HEADSET H-182/PT..... EA	1	
						GROUP 01		
ANTENNA SYSTEM,			H16GH FREQUENCY					
2	1	PAFFF	5895-00-4938818	SMB39697	80063	COUPLER AND GROUND PLATE ASSY.. EA	2	
2	2	PAFFF	5895-00-53-0484	RAC30	82679	COUPLER. ANTENNA..... EA	2	
						GROUP 0101		
						MAST, ANTENNA		
3	1	PAFZZ	5985-00-252-1733	AB746G	82679	ANTENNA MAST..... EA	1	
3	2	PAFZZ	5306-00-576-0569	29534	90190	STUD. DRIVING STEEL..... EA	3	
3	3	PAFZZ	3940-00-408-1485	SCB22795	80063	BLOCK, PULLEY..... EA	3	
3	4	PAFZZ	4030-00-953-2344	6760-1-41N	79577	SWIVEL EYE AND JAW EA	6	
3	5	PAFHD	5995-00-953-0601	SMB396931	80063	CABLE ASSY, RADIO FREQUENCY..... EA	1	
3	6	PAFZZ	5970-00-198-6388	A102	81679	INSULATOR. STAIN FEED THRU EA	3	
3	7	PAFZZ	5895-00-885-8606	TDR002.5	79615	TRANSMITTER, TERMINATOR..... EA	2	
3	B	PAFZZ	5895-00-537-2358	A1176	82679	ANTENNA COUPLER SUB ASSY EA	1	
3	9	PAFZZ	5895-00-857-1498	1047-417D14	97983	COUPLER AND GROUND PLATE ASSY.. EA	1	
3	10	PAFZZ	5895-00-553-7024	TRC500	82679	COUPLER, ANTENNA EA	2	
3	11	PAFZZ	6145-00-170-7829	RG86U	2679	CABLE. RADIO FREQUENCY EA	250	
3	12	PAFZZ	5895-00-857-1497	SMC96980	80063	TERMINATOR ASSY. RECEIVER EA	4	
3	13	PAFZZ	5895-00-874-3420	231-8-1	92755	TERMINATOR UNIT, RHOMBIC..... EA	4	
3	14	PAFZZ	6145-00-195-0400	SCL692	81349	WIRE. ELECTRICAL EA	550	
3	15	PAFZZ	4030-00-402-6566	SCC2943-3	80063	THIMBLE, STEEL..... EA	1	
3	16	PAFZZ	5970-00-953-4907	SMB396942-8	8006	PLATE ANTENNA TRIANGLE EA	3	
3	17	PAFZZ	5970-00-954-5130	FG1-1200	20625	INSULATOR. STAIN FIBERGLASS EA	16	
3	18	PAFZZ	5310-00-550-1720	9534	90190	COUPLING. GROUND ROD EA	3	
3	19	PAFZZ	5970-00-475-2499	A957-15	20625	INSULATOR SPREADER GLASS..... EA	16	
3	20	PAFZZ	5895-00-439-8770	SMC396981	8006	TERMINATOR, AND GROUND ROD..... EA	2	
3	21	PAFHD	5995-00-889-0400	SMB396929	80063	CABLE ASSEMBLY, RADIO FREQUENCYEA	3	
3	22	PAFZZ	5970-00-295-7617	136-126	74970	INSULATOR, SPREADER, PORCELAIN... EA	16	
					6			

SECTION II REPAIR PARTS LIST

(1) ILLUSTRATION		(2)	(3)	(4)	(5)	(6) DESCRIPTION	(7)	(8)
(a) FIG NO.	(b) ITEM NO.	SMR CODE	NATIONAL STOCK NUMBER	PART NUMBER	FSCM	USABLE ON CODE	U/M	QTY INC IN UNIT
3	23	PAFZZ	5895-00-874-3419	1047-417D16	97983	STAKE, TERMINATOR MOUNTING..... EA	2	
3	24	PAFZZ	4030-00-954-0813	88100	73569	ANCHOR GUY EA	12	
3	25	PAFZZ	4030-00-953-2327	H6428	73569	ROD, ANCHOR EA	10	
3	26	PAFZZ	6145-00-161-0885	RG11AU	82679	CABLE, RADIO FREQUENCY EA	850	
3	27	PAFZZ	2530-00-591-5175	95026	32699	GROUND SPIKE EA	48	
3	28	PAFZZ	5999-00-186-3976	SC8176514	80063	CLAMP V/W 8 FT GROUND ROD EA	18	
3	29	PAFZZ	5975-00-246-0707	1047-4170	97983	ROD GROUNDING EA	18	
3	30	PAFZZ	5940-00-577-6076	6V27502-6	77554	CONNECTOR, SOLDERLESS..... FT	100	
3	31	PAFZZ	6145-00-857-6903	MILW3861	81349	WIRE, ELECTRICAL FT	100	
3	32	PAFZZ	5935-00-171-3006	UG95AN	96906	CONNECTOR, PLUG, ELECTRICAL..... EA	3	
3	33	PAFZZ	5935-00-222-7420	UG94A	96906	CONNECTOR, PLUG, ELECTRICAL..... EA	6	
3	34	PAFZZ	5975-00-875-1295	29435	29435	ROD, GROUND..... EA	14	
3	35	PAFZZ	4030-00-953-2346	2454	08097	SHACKLE, ANCHOR TYPE EA	18	
3	36	PAFZZ	6145-00-129-9320	Q00345	81349	WIRE, COPPERWELD EA	500	
3	37	PAFZZ	5975-00-223-4627	1047-41705	97983	ROPE, NYLON FT	3	
3	38	PAFFD	8130-00-656-1090	RC435U	80058	REEL CABLE EA	2	
3	39	PAFZZ	4030-00-187-5261	GP2	80063	STAKE, GROUND..... EA	20	
3	40	PAFZZ	4030-00-282-2510	75535	80063	THIMBLE EA	30	
3	41	PAFZZ	5975-00-257-1230	9F	77554	CONNECTOR, SOLDERLESS..... EA	66	
3	42	PAFZZ	5970-00-995-9288	FGI-1200S	79614	INSULATOR, SPREADER FIREGLASS EA	16	
3	43	PAFZZ	5940-00-577-7076	DS09F	15826	SPLICE CONNECTOR..... EA	48	
3	44	PAFZZ	4030-00-066-7236	22302G1	82679	ROD ASSEMBLY EA	3	
3	45	PAFZZ	5895-00-953-4935	158	82679	HANDLE EA	1	
3	46	PAFZZ	5895-00-056-3834	22452G1	82679	STUB SECTION EA	1	
3	47	PAFZZ	4010-00-066-2749	22448G1	82679	GUY 30-FT EA	1	
3	48	PAFZZ	5895-00-066-7232	24505G1	82679	CAP MAST EA	1	
3	49	PAFZZ	5895-00-066-2723	2230161	82679	BASE MAST EA	1	
3	50	PAFZZ	5895-00-053-1770	22187G2	82679	GUY EA	3	
3	51	PAFZZ	5895-00-053-1773	22186G1	82679	GUY EA	6	
3	52	PAFZZ	4030-00-066-7235	164G01	82679	REEL GUY EA	3	
3	53	PAFZZ	3950-00-932-9751	TU17	82679	HOIST..... EA	1	
3	54	PAFZZ	4030-00-954-0169	MX7738	182679	GROUND ANCHOR EA	3	
3	55	PAFZZ	5985-00-937-0780	AB998	82679	MAST ASSEMBLY EA	1	
3	56	PAFZZ	5895-00-964-3207	A8746G	82679	MAST AB-746/G /50 FT/..... EA	1	
						GROUP 02		
						SHELTER, ELECTRICAL EQUIPMENT		
4	1	PAFZZ	5935-00-885-8621	3086	79725	ADAPTER, ELECTRICAL CONDUIT EA	3	
4	2	PAFZZ	5975-00-886-3265	3089E	79725	ADAPTER, ELECTRICAL CONDUIT EA	1	
4	3	PAFZZ	5975-00-475-2407	3017TC	79725	BEND, ELECTRICAL CONDUIT EA	1	
4	4	PAFZZ	5935-00-886-3252	MNAC75P8	59730	CONNECTOR, ARMORED CABLE..... EA	3	
					7			

SECTION II REPAIR PARTS LIST

(1) ILLUSTRATION		(2)	(3)	(4)	(5)	(6)	(7)	(8)
(a) FIG NO.	(b) ITEM NO.	SMR CODE	NATIONAL STOCK NUMBER	PART NUMBER	FSCM	DESCRIPTION USABLE ON CODE	U/M	QTY INC IN UNIT
4	5	PAFZZ	5935-00-258-1270	7092	74545	CONNECTOR, PLUG, ELECTRICAL..... EA	2	
4	6	PAFZZ	5935-00-813-0620	2127GA	79725	CONNECTOR, RECEP, ELECTRICAL EA	5	
4	7	PAFZZ	5935-00-851-5699	2127G8	79725	CONNECTOR, RECEP, ELECTRICAL EA	5	
4	8	PAFZZ	5935-00-105-7724	2027GB	79725	CONNECTOR, RECEP, ELECTRICAL EA	8	
4	9	PAFZZ	5935-00-874-3424	5261	83315	CONNECTOR, RECEP, ELECTRICAL EA	1	
4	10	PAFZZ	5935-00-259-3323	9200	74545	CONNECTOR, RECEP, ELECTRICAL EA	3	
4	11	PAFZZ	5935-00-259-3313	72108	74545	CONNECTOR, RECEP, ELECTRICAL EA	7	
4	12	PAFZZ	5935-00-257-6397	7410-8	74455	CONNECTOR, RECEP, ELECTRICAL EA	1	
4	13	PAFZZ	5935-00-259-3336	55668	74545	CONNECTOR, RECEP, ELECTRICAL EA	2	
4	14	PAFZZ	5995-00-876-2357	P2AA	64959	CORD, ELECTRICAL..... EA	1	
4	15	PAFZZ	5995-00170-6887	P2A	64959	CORD, ELECTRICAL..... EA	1	
4	16	PAFZZ	5975-00-475-2409	6G3001A	79725	COUPLING, ELECTRICAL CONDUIT..... EA	1	
4	17	PAFZZ	5935-00-160-1028	373A	64959	DUMMY PLUG, TELEPHONE..... EA	4	
4	18	PAFZZ	5935-00-162-6285	1650	64959	DUMMY PLUG, TELEPHONE..... EA	4	
4	19	PAFZZ	4140-00-842-1131	F1C2	8287	FAN AXIAL, MUFFIN TYPE..... EA	4	
4	20	PAFZZ	6240-00-763-7744	NSI820387	96906	LAMP, INCANDESCENT..... EA	10	
4	21	PAFZZ	6210-00-028-0043	212710	79725	LAMPHOLDER, RECEPTACLE EA	20	
4	22	PAFZZ	5935-00-192-4882	2418	64959	PLUG, TELEPHONE EA	16	
4	23	PAFZZ	5935-00-192-4774	2418	64959	PLUG, TELEPHONE EA	161	
4	24	PAFZZ	5895-00-88-5975	S6122	05580	SHADE, LAMP EA	10	
4	25	PAFZZ	5930-00-923-0300	8ZE6-2RQ01	1590&	SWITCH, SENSITIVE..... EA	1	
4	26	PAFZZ	5930-00-240-3704	7610K2	15605	SWITCH, TOGGLE EA	1	
4	27	PAFZZ	5930-00-636-4014	9711	74545	SNITCH, TOGGLE EA	3	
						GROUP 0201 BOX, SIGNAL ENTRANCE		
5	1	PAFZZ	5915-00-860-9557	FA9842	51932	FILTER, RADIO FREQUENCY..... EA	20	
5	2	PAFZZ	5940-00-223-5293	9766-28ULACK	00629	POST BINDING BLACK EA	52	
5	3	PAFZZ	5940-00-283-5393	44	72825	CAP, RUBBER EA	521	
5	4	PAFZZ	5915-0-400-0844	CE223277	98230	FILTER RADIO FREQUENCY..... EA	321	
						GROUP 0202 BOX, POWER ENTRANCE		
6	1	PAFZZ	5935-00-858-243	ZZNMFB1716	49367	CONNECTOR, RECEP, ELECTRICAL EA	3	
6	2	PAFZZ	5935-00-892-9069	ZZNMF5616	49367	CAP, ELECTRICAL EA	3	
6	3	PAFZZ	593500-804-0664	ZZNW7516	49367	NUT, PLAIN, KNURLED, ALUMINUM..... EA	1	
						GROUP 0203 BOX, HF TRANSMITTING ENTRANCE		
7	1	PAFZZ	5935-00-404-7965	S0-239	80063	CONNECTOR, RECEP, ELECTRICAL EA	2	
					8			

SECTION II REPAIR PARTS LIST

(1) ILLUSTRATION		(2)	(3)	(4)	(5)	(6) DESCRIPTION	(7)	(8)
(a) FIG NO.	(b) ITEM NO.	SMR CODE	NATIONAL STOCK NUMBER	PART NUMBER	FSCM	USABLE ON CODE	U/M	QTY INC IN UNIT
8	1	PAFZZ	5735-00-404-7965	SO-239	80063	GROUP 0204 BOX, HF RECEIVING ENTRANCE CONNECTOR, RECEPTACLE, ELECTRICAL EA	2	
9		XDFFF		A123	82679	GROUP 0205 DOLLY SET, LIFT, TRANSPORTABLE SHELTER DOLLY SET, LIFT, TRANSPORTABLE SHELTER /M689/..... EA	1	
10		PDFFF		AX5146	92679	PANEL ASSEMBLY SWITCHING EA	1	
10	1	PAFZZ	5935-00-823-0308	JS92U	80058	CONNECT RECEPTACLE, ELEC..... EA	12	
10	2	PAFZZ	5935-00-835-0508	UG88U	80051	CONNECTOR, PLUG, ELECTRICAL..... EA	3	
10	3	PAFZZ		ST22N	82679	SWITCH, TOGGLE EA	1	
10	4	XBFZZ		MS1184	82679	HOLDER, CARD EA	1	
10	5	PAFZZ	5930-00-729-8453	13036	82389	SWITCH, TOGGLE EA	1	
10	6	XBFZZ		600A4	75352	TERMINAL STRIP..... EA	1	
10	7	XBFZZ		RG58U	80058	CABLE. RADIO FREQUENCY EA	2	
10	8	XBFZZ		CA480-5-600	82679	CABLE ASSEMBLY, RADIO FREQ. EA	2	
10	9	X8FZZ		CA1710	82679	WIRING HARNESS. BRANCHED..... EA	1	
10	10	XBFZZ		MS6366	82679	PANEL, SWITCHING EA	11	
11	1	XBDZZ		MS6058	82679	GROUP 0303 OSCILLATOR, RADIO FREQUENCY 0-1706/TSC-25 EA	1	
11	2	XBDZZ		ItS60059	82679	COVER. TOP EA	1	
10	3	X8DZZ		8XA100	82679	COVER, BOTTOM..... EA	1	
12	1	XBDZZ		MS6058	82679	GROUP 030301 EXCITER, MULTIMODE BRA-106 EA	1	
12	2	XBDZZ		MS6059	82679	COVER, TOP EA	1	
12	3	XBFZZ		LD2208MS6007	82679	COVER, BOTTOM..... EA	1	
12	4	XBFZZ		LD2146	82679	BRACKET. SNITCH MOUNTING..... EA	1	
13		PADZZ	5820-01-010-4975	A4524	82679	DIAL, MARKING..... EA	6	
13	1	PADZZ	5905-00-109-3580	RC07GP22J	81349	GROUP 03030101 CIRCUIT CARD, CARRIER GENERATOR Z109 CIRCUIT CD, CARRIER GENERATOR EA	1	
13	2	PADZZ	5905-00-106-1359	RCO7GF152J	81349	RESISTOR, FIXED, COMPOSITION EA	1	
					9	RESISTOR, FIXED, COMPOSITION..... EA	4	

SECTION II REPAIR PARTS LIST

(1) ILLUSTRATION		(2)	(3)	(4)	(5)	(6)	(7)	(8)
(a) FIG NO.	(b) ITEM NO.	SMR CODE	NATIONAL STOCK NUMBER	PART NUMBER	FSCM	DESCRIPTION USABLE ON CODE	U/M	QTY INC IN UNIT
13	3	PADZZ		CC100-41	82679	CAPACITOR, FIXED, CERAMIC DIELECTRIC..... EA	14	
13	4	XBDZZ	5940-00-159-0245	X1417B	71279	TERMINAL, STUD..... EA	6	
13	5	PADZZ	5905-00-110-7620	ICO0F102J	81349	RESISTOR, FIXED, COMPOSITION..... EA	15	
13	6	PADZZ	5905-00-119-3504	RCO7FI273J	B1349	RESISTOR, FIXED, COMPOSITION..... EA	2	
13	7	PADZZ	5962-00-837-7276	UX992328X	07263	NETWORK FREQUENCY DIV..... EA	2	
13	a	PADZZ	5961-00-847-4474	1M746	81349	SEMICONDUCTOR DEVICE, DIODE..... EA	1	
13	9	PADZZ	5905-00-120-9154	RCOTGF471J	81149	RESISTOR, FIXED, COMPOSITION..... EA	4	
13	10	PADZZ	5905-00-935-8544	RC20GF181J	81349	RESISTOR, FIXED, COMPOSITION..... EA	1	
13	11	PADZZ	5905-00-106-3666	RC07GF103J	81349	RESISTOR, FIXED, COMPOSITION..... EA	9	
13	1t	PADZZ	5905-00-118-4559	RC07GF333J	81349	RESISTOR, FIXED, COMPOSITION..... EA	4	
13	13	PADZZ		CM112F392F5S	81349	CAPACITOR, FIXED, MICA DIELECTRIC..... EA	3	
13	14	PADZZ	5961-00-062-3133	2N3646	81349	TRANSISTOR..... EA	14	
13	15	PADZZ	5910-00-775-4045	8131M03X5V0104Z	18796	CAPACITOR, FIXED, CERAMIC DIELECTRIC..... EA	17	
13	16	XBDZZ		C1136-5	82679	CORE..... EA	1	
13	17	PADZZ	5950-01-006-9911	TT285-11	82679	TRANSFORMER .ADJUSTABLE..... EA	1	
13	17A	PADZZ	5950-01-008-8631	TT285-12	82679	TRANSFORMER, RADIO FREQ., ADJ..... EA	1	
13	17B	PADZZ	5950-01-011-1869	TT285-15	82679	TRANSFORMER, RADIO FREQ., ADJ..... EA	1	
13	18	PADZZ	5905-00-141-1183	RC07GF101J	81349	RESISTOR, FIXED COMPOSITION..... EA	6	
13	19	XBDZZ		C1136-5	82679	CORE..... EA	1	
13	20	PADZZ		NLW2-25	56289	CAPACITOR, FIXED, ELECTROLYTIC..... EA	1	
13	21	PADZZ	5910-00-939-7396	5815-200Y5U0204Z	11796	CAPACITOR, FIXED CERAMIC DIELECTRIC..... EA	2	
13	22	PADZZ		62P100	80740	RESISTOR, VARIABLE COMPOSITION..... EA	1	
13	23	PADZZ		62P1000	80740	RESISTOR, VARIABLE, COMPOSITION..... EA	1	
13	24	PADZZ	5905-00-131-1255	RC07GF122J	81349	RESISTOR, FIXED, COMPOSITION..... EA	2	
13	25L	PADZZ		NLW25-25	56289	CAPACITOR, .FIXED, ELECTROLYTIC..... EA	1	
13	26	PADZZ	5910-00-992-2473	NLW175-15	56289	CAPACITOR, FIXED, ELECTROLYTIC..... EA	1	
13	27	PAD2		WEE1000UH	83125	COIL, RADIO FREQUENCY, FIXED..... EA	3	
13	28	PADZZ	5910-00-995-8615	NLW125-15	56289	CAPACITOR, FIXED, ELECTROLYTIC..... EA	4	
13	29	PADZZ		NLN10-25	56289	CAPACITOR, FIXED ELECTROLYTIC..... EA	2	
13	30	PADZZ	5905-00-116-8556	RC07GF223J	81349	RESISTOR, FIXED, COMPOSITION..... EA	2	
13	31	PADZZ	5905-00-126-6683	RC07GF332J	81349	RESISTOR, FIXED, COMPOSITION..... EA	4	
13	32	PADZZ	5905-00-110-7622	RC07GF682J	81349	RESISTOR, FIXED COMPOSITION..... EA	1	
13	33	PADZZ	5905-00-114-0711	RC07GF472J	81349	RESISTOR, FIXED, COMPOSITION..... EA	3	
13	34	PADZZ		NLW2-50	56289	CAPACITOR, FIXED, ELECTROLYTIC..... EA	2	
13	35	XBDZZ	5310-00-171-8727I	NTH0440BN6	82679	NUT, PLAIN, HEXAGON..... EA	2	
13	36	PADZZ		LWE04MRN	26479	WASHER, LOCK..... EA	2	
13	37	XBDZZ		FW04HBN	82679	WASHER, FLAT..... EA	2	
13	38	XBDZZ		MS6004	82679	STIFFENER, PC BOARD..... EA	1	
13	39	XBDZZ		SCBP044OBN5	82679	SCREW, .MACHINE..... EA	1	
13	4	XBDZZ		PC339	82679	PRINTED WIRING BOARD..... EA	1	

SECTION II REPAIR PARTS LIST

(1) ILLUSTRATION		(2)	(3)	(4)	(5)	(6) DESCRIPTION	(7)	(8)
(a) FIG NO.	(b) ITEM NO.	SMR CODE	NATIONAL STOCK NUMBER	PART NUMBER	FSCM	USABLE ON CODE	U/M	QTY INC IN UNIT
13	41	PADZZ	5961-00-170-4430	IN34A	81349	SEMICONDUCTOR, DEVICE, DIODE EA	1	
13	42	PADZZ	5905-00-105-7776	RC07GF561J	81349	RESISTOR, FIXED, COMPOSITION..... EA	5	
13	43	PADZZ	5905-00-113-4861	RC07GF390J	81349	RESISTOR, FIXED, COMPOSITION..... EA	1	
13	44	PADZZ	5905-00-104-8368	RC07GF470J	81349	RESISTOR, FIXED, COMPOSITION..... EA	2	
13	45	PADZZ	5905-00-119-3503	RC07GF271J	81349	RESISTOR, FIXED, COMPOSITION..... EA	1	
13	46	XBDZZ		CI136-5	82679	CORE EA	1	
13	47	PADZZ	5905-00-106-1278	RC07CF123J	81349	RESISTOR, FIXED, COMPOSITION..... EA	1	
13	48	PADZZ	5905-00-114-5343	RC07GF182J	81349	RESISTOR, FIXED, COMPOSITION..... EA	1	
13	49	PADZZ	5950-01-007-1799	251	31669	TRANSFORMER, AUDIO FREQUENCY ... EA	1	
13	50	PADZZ	5950-00-106-3667	RC07GF120J	81349	RESISTOR, FIXED, .COMPOSITION..... EA	1	
13	51	PADZZ		62P500	80740	RESISTOR, VARIABLE, COMPOSITION... EA	1	
13	52	PADZZ	5905-00-114-0710	RC07GF331J	81349	RESISTOR, FIXED, COMPOSITION..... EA	2	
13	53	PADZZ		0831-000Z5V00102	18796	CAPACITOR. FIXED, CERAMIC DIELECTR..... EA	2	
13	54	PADZZ		CM111F361F5S	01349	CAPACITOR. FIXED, MICA DIELECTR..... EA	2	
13	55	PADZZ		TT285-23	82679	TRANSFORMER, RADIO FREQ., ADJ. EA	1	
13	56	XBDZZ		CI136-6	82679	CORE EA	1	
13	57	XBDZZ		IM236-1	82679	INSULATOR, FILTER..... EA	1	
13	58	PADZZ	5915-01-016-3778	FX267	62679	FILTER, BANDPASS..... EA	1	
13	59	PADZZ		62P5000	80740	RESISTOR, VARIABLE, COMPOSITION... EA	1	
13	60	PADZZ	5950-01-035-5727	TT285-22	82679	TRANSFORMER, RADIO FREQ..... EA	1	
13	61	PADZZ	5950-00-003-4725	WEE220UH	83125	COIL, RADIO FREQUENCY, FIXED EA	2	
13	62	PADZZ		CC100-40	82679	CAPACITOR, FIXED, CERAMIC DIELECTR..... EA	2	
						GROUP 03030102		
						CIRCUIT CARD, COMB FILTER A Z102		
14		PAHDD	5820-01-010-4976	A4500	82679	CIRCUIT CARD. C. FILTER A 2182..... EA	1	
14	1	PADZZ	5903-00-105-7767	RC07GF474J	81349	RESISTOR, FIXED, COMPOSITION..... EA	6	
14	2	PADZZ	5905-00-141-1183	RC07GF101J	81349	RESISTOR, FIXED, COMPOSITION..... EA	6	
14	3	PADZZ	5905-00-105-7768	RC07GF561J	81349	RESISTOR, .FIXED. COMPOSITION..... EA	12	
14	4	PADZZ	5905-00-109-8358	RC07GF822J	81349	RESISTOR, FIXED, COMPOSITION..... EA	6	
14	5	PADZZ		CR109-100	82679	CRYSTAL UNIT.fQUARTZ EA	1	
14	6	PADZZ	5935-00-959-4929	8000AG10	91506	SOCKET, CRYSTAL EA	6	
14	7	PADZZ	5910-00-910-6103	815-016X5V02003I	18796	CAPACITOR, FIXED. CERAMIC DIELECTR..... EA	30	
14	8	PADZZ		CM112F182G5S	81349	CAPACITOR, FIXED, MICA DIELECTR..... EA	4	
14	9	PADZZ	5955-01-035-5232	CR109-98	82679	CRYSTAL UNIT. QUARTZ..... EA	1	
14	10	XBDZZ	5940-00-159-0245	X1457B	71279	TERMINAL, STUD..... EA	12	
14	11	PADZZ	5910-00-471-5168	538-011-110D	18796	CAPACITOR, VARIABLE. CERAMIC..... EA	6	
14	12	PADZZ		CM111C100J5S	81349	CAPACITOR, FIXED. MICA DIELECTR..... EA	6	
14	13	PADZZ	5961-00-062-3133	2N3646	81349	TRANSISTOR..... EA	12	
14	14	PADZZ	5910-00-946-2288	538-002-92A	18796	CAPACITOR, VARIABLE, CERAMIC..... EA	6	
14	15	PADZZ	5905-00-110-7620	RC07GF102J	81349	RESISTOR, FIXED. COMPOSITION..... EA	6	
14	16	PADZZ		CN112F242G5S	61349	CAPACITOR, FIXED, MICA DIELECTR..... EA	2	
14	17	PADZZ	5955-01-035-5226	CR109-96	82679	CRYSTAL UNIT, QUARTZ..... EA	1	
					11			

SECTION II REPAIR PARTS LIST

(1) ILLUSTRATION		(2)	(3)	(4)	(5)	(6) DESCRIPTION	(7)	(8)
(a) FIG NO.	(b) ITEM NO.	SMR CODE	NATIONAL STOCK NUMBER	PART NUMBER	FSCM	USABLE ON CODE	U/M	QTY INC IN UNIT
14	18	PADZZ	5905-00-116-8555	RCO7GF153J	81349	RESISTOR, FIXED, COMPOSITION..... EA	1	
14	19	PADZZ	5910-00-391-2260	0811000X5V00103P	18796	CAPACITOR, FIXED, CERAMIC DIEL..... EA	12	
14	20	PADZZ	5955-01-035-5225	CR109-94	82679	CRYSTAL UNIT, QUARTZ..... EA	1	
14	21	PADZZ		CM112F272F5S	81349	CAPACITOR, FIXED, MICA DIEL..... EA	4	
14	22	PADZZ		0831-000Z5V00102	18796	CAPACITOR, FIXED, CERAMIC DIEL..... EA	1	
14	23	PADZZ	5950-01-036-5585	CR109-92	82679	CRYSTAL UNIT, QUARTZ..... EA	1	
14	24	PADZZ	5955-01-035-5224	CR109-90	81679	CRYSTAL UNIT, QUARTZ..... EA	1	
14	25	XBDZZ	5310-00-171-8727	NTH0440BN6	82679	NUT, PLAIN, HEXAGON..... EA	1	
14	26	PADZZ		LWE04MRN	12679	WASHER, LOCK..... EA	1	
14	27	XBDZZ		FW04HBN	12649	WASHER, FLAT..... EA	1	
14	28	XBDZZ		MS6004	82679	STIFFENER, PC BOARD..... EA	1	
14	29	XBDZZ		SCBP0440BN5	82T67	SCREW, MACHINE..... EA	1	
14	30	XBDZZ		PC304	82679	PRINTED WIRING BOARD..... EA	1	
14	31	PADZZ		CM112F392G3S	1349	CAPACITOR, FIXED, MICA DIEL..... EA	2	
14	32	PADZZ	5950-01-006-8295	TT286-2	82679	TRANSFORMER, RADIO FREQ., ADJ..... EA	4	
14	33	XBDZZ		C1136-5	82679	CORE..... EA	12	
14	34	PADZZ		62P500	80740	RESISTOR, VARIABLE, COMPOSITION... EA	6	
14	3S	PADZZ	3990-00-344-1863	WEE120UH	83125	COIL, RADIO FREQUENCY, FIXED..... EA	12	
14	36	PADZZ	5905-00-126-4483	RCO7GF332J	1349	RESISTOR, FIXED, COMPOSITION..... EA	6	
14	37	PADZZ	5950-01-006-8296	TT286-4	82679	TRANSFORMER, RADIO FREQ., ADJ..... EA	2	
14	30	PADZZ	5950-01-006-8297	TT286-6	82679	TRANSFORMER, RADIO FREQ., ADJ..... EA	4	
14	39	PADZZ	5950-01-006-8298	TT286-8	2679	TRANSFORMER, RADIO FREQ., ADJ..... EA	2	
						GROUP 03030103		
						CIRCUIT CARD, COMB FILTER B Z103		
15		PAHDD	5820-01-010-4977	A4501	02679	CIRCUIT CD, COMB FILTER B Z103..... EA	1	
15	1	PADZZ	5905-00-105-7767	RCO7GF474J	81349	RESISTOR, FIXED, COMPOSITION..... EA	6	
15	2	PADZZ	5905-00-141-1183	RCO7GF101J	81349	RESISTOR, FIXED, COMPOSITION..... EA	6	
15	3	PADZZ	5905-00-105-7768	RCO7GF561J	81349	RESISTOR, FIXED, COMPOSITION..... EA	12	
15	4	PADZZ	5905-00-109-8358	RCO7GF822J	81349	RESISTOR, FIXED, COMPOSITION..... EA	6	
15	5	PADZZ		CR109-101	82679	CRYSTAL UNIT, QUARTZ..... EA	1	
15	6	PADZZ	5935-00-939-4929	8000AG10	91504	SOCKET, CRYSTAL..... EA	6	
15	7	PADZZ	3910-00-910-6103	815-016X5V02003I	18796	CAPACITOR, FIXED, CERAMIC DIEL..... EA	30	
15	8	PADZZ		CM112F202G5S	81349	CAPACITOR, FIXED, MICA DIEL..... EA	2	
15	9	PADZZ	5950-01-035-5233	CR109-99	82679	CRYSTAL UNIT, QUARTZ..... EA	1	
15	10	XBDZZ	5940-00-159-0245	X1457B	71279	TERMINAL, STUD..... EA	12	
15	11	PADZZ	5910-00-471-5168	538-011-110D	18796	CAPACITOR, VARIABLE, CERAMIC..... EA	6	
15	12	PADZZ		CM111C100J5S	81349	CAPACITOR, FIXED, MICA DIEL..... EA	4	
15	13	PADZZ	5961-00-062-3133	2N3646	81349	TRANSISTOR..... EA	12	
15	14	PADZZ	5910-00-944-2208	538-002-92A	18796	CAPACITOR, VARIABLE, CERAMIC..... EA	6	
15	15	PADZZ	5905-00-110-7620	RCO7GF102J	81349	RESISTOR, FIXED, COMPOSITION..... EA	6	
15	16	PADZZ		CM112F222F5S	81349	CAPACITOR, FIXED, MICA DIEL..... EA		
					12			

SECTION II REPAIR PARTS LIST

(1) ILLUSTRATION		(2)	(3)	(4)	(5)	(6)	(7)	(8)
(a) FIG NO.	(b) ITEM NO.	SMR CODE	NATIONAL STOCK NUMBER	PART NUMBER	FSCM	DESCRIPTION USABLE ON CODE	U/M	QTY INC IN UNIT
15	17	PADZZ	5955-01-035-5232	CR109-97	82679	CRYSTAL UNIT. QUARTZ..... EA	1	
15	18	PADZZ	5905-00-116-8555	RC07GF153J	81349	RESISTOR. FIXED, COMPOSITION..... EA	6	
15	19	PADZZ	5910-00-591-2260	0811000X5V00103P	18796	CAPACITOR, FIXED, CERAMIC DIELECTRIC..... EA	12	
15	20	PADZZ	5955-01-035-5231	CR109-95	82679	CRYSTAL UNIT, QUARTZ..... EA	1	
15	21	PADZZ		0831-000Z500102	18796	CAPACITOR. FIXED, CERAMIC DIELECTRIC..... EA	6	
15	22	PADZZ	5055-01-036-5230	CR109-93	82679	CRYSTAL UNIT, QUARTZ..... EA	1	
15	23	PADZZ		CM112F332FS	81349	CAPACITOR, FIXED MICA DIELECTRIC..... EA	4	
15	24	PADZZ	5956-00-013-6229	CR109-91	82679	CRYSTAL UNIT, QUARTZ..... EA	1	
15	25	XBDZZ	5310-00-171-8727	NTHO440BN6	82679	NUT, PLAIN, HEXAGON..... EA	1	
15	26	PADZZ		LWE04MRN	82679	WASHER, LOCK..... EA	1	
15	27	XBDZZ		FW04HBN	82679	WASHER, FLAT..... EA	1	
15	28	XBDZZ		MS6004	82679	STIFFENER, PC BOARD..... EA	1	
15	29	XBDZZ		SCBP0440BN5	82679	SCREW. MACHINE..... EA	1	
15	30	XBDZZ		PC304	82679	PRINTED WIRING BOARD..... EA	1	
15	31	PADZZ	5950-01-006-8295	TT286-2	82679	TRANSFORMER, RADIO FREQ. ADJ..... EA	2	
15	32	XBDZZ		C1136-5	82679	CORE..... EA	12	
15	33	PADZZ		62P500	80740	RESISTOR, VARIABLE, COMPOSITION..... EA	6	
15	34	PADZZ	5950-00-344-1863	WEE120UH	83125	COIL. RADIO FREQUENCY. FIXED..... EA	12	
15	35	PADZZ	5905-00-126-6683	RC07GF332J	81349	RESISTOR, FIXED. COMPOSITION..... EA	6	
15	36	PADZZ	5950-00-126-6683	TT286-4	82679	TRANSFORMER, RADIO FREQ., ADJ..... EA	4	
15	37	PADZZ	5950-01-006-8296	TT286-6	82679	TRANSFORMER, RADIO FREQ., ADJ..... EA	2	
15	38	PADZZ	5950-01-006-8298	TT286-8	82679	TRANSFORMER, RADIO FREQ., ADJ..... EA	4	
15	39	PADZZ		CM12F162G55	81349	CAPACITOR, FIXED, MICA DIELECTRIC..... EA	2	
GROUP 03030104								
CIRCUIT CARD, FREQUENCY SHIFT GENERATOR							Z108	
16		PAHDD	5820-01-010-4979	A4525	82679	CIRCUIT CD, FS GENERATOR 2108..... EA	1	
16	1	PADZZ		CC100-41	82679	CAPACITOR, FIXED. CERAMIC DIELECTRIC..... EA	18	
16	2	PADZZ		WEE100UH	83125	COIL, RADIO FREQUENCY, FIXED..... EA	2	
16	3	PADZZ	5811-00-349-8742	M6	27956	NETWORK, MIXER, DOUBLE BALANCED..... EA	1	
16	4	PADZZ		CM111F361G5S	81349	CAPACITOR, FIXED, MICA DIELECTRIC..... EA	2	
16	5	PADZZ	5950-01--07-1837	TT285-16	82679	TRANSFORMER, RADIO FREQ., ADJ..... EA	2	
16	6	XBDZZ		C1136-5	82679	CORE..... EA	2	
16	7	PADZZ	5905-00-105-7768	RC07GF561J	81349	RESISTOR, FIXED COMPOSITION..... EA	1	
16	B	XBDZZ	5940-00-159-0245	X1457B	71279	TERMINAL, STUD..... EA	7	
16	9	PADZZ	5905-00-141-1183	RC07GF101J	81349	RESISTOR. FIXED, COMPOSITION..... EA	2	
16	10	PADZZ	5905-00-116-8555	RC07GF153J	81349	RESISTOR, FIXED, COMPOSITION..... EA	2	
16	11	PADZZ	5905-00-120-9154	RC07GF471J	81349	RESISTOR, FIXED, COMPOSITION..... EA	4	
16	12	PADZZ	5961-00-062-3133	2N3646	81349	TRANSISTOR..... EA	6	
16	13	PADZZ	5905-00-110-7620	RC07GF102J	81349	RESISTOR, FIXED, COMPOSITION..... EA	6	
16	14	PADZZ	5905-00-114-5343	RC07GF182J	81349	RESISTOR. FIXED COMPOSITION..... EA	1	
16	15	PADZZ	5915-01-016-8232	FX268	82679	FILTER. BANDPASS..... EA	1	

SECTION II REPAIR PARTS LIST

(1) ILLUSTRATION		(2)	(3)	(4)	(5)	(6)	(7)	(8)
(a) FIG NO.	(b) ITEM NO.	SMR CODE	NATIONAL STOCK NUMBER	PART NUMBER	FSCM	DESCRIPTION USABLE ON CODE	U/M	QTY INC IN UNIT
16	16	PADZZ	5961-00-170-4430	IN34A	81349	SEMICONDUCTOR DEVICE, DIODE	EA	4
16	17	PADZZ		CMIIF331GSS	81349	CAPACITOR, FIXED, MICA DIEL	EA	1
16	18	PADZZ	5905-00-141-0717	RC07GF473J	81349	RESISTOR, FIXED, COMPOSITION.....	EA	5
16	19	PADZZ	5961-00-840-3561	2N696	81349	TRANSISTOR.....	EA	5
16	20	PADZZ		0831-000Z5V00102	18796	CAPACITOR, FIXED, CERAMIC DIEL.....	EA	3
16	21	PADZZ	5905-00-106-3666	RC07GF103J	81349	RESISTOR. FIXED, COMPOSITION.....	EA	5
16	22	PADZZ	5905-00-110-7622	RC07GF682J	81349	RESISTOR, FIXED, COMPOSITION.....	EA	1
16	23	PADZZ	5961-00-054-0046	2N1711	81349	TRANSISTOR.....	EA	2
16	24	PADZZ	5905-00-851-2401	3250P1-102	32997	RESISTOR, VARIABLE, WIREWOUND	EA	2
16	25	PADZZ	5905-00-114-0710	RC07GF331J	81349	RESISTOR. FIXED, COMPOSITION.....	EA	2
16	26	PADZZ	5961-00-852-7549	IN754A	81349	SEMICONDUCTOR DEVICE, DIODE	EA	1
16	27	PADZZ	5905-00-255-3664	3250PI-1D3	32997	RESISTOR, VARIABLE, WIREWOUND	EA	3
16	28	XBDZZ	5310-00-171-8727	NTH04408N6	82679	NUT, PLAIN, HEXAGON	EA	3
16	29	PADZZ		LWE04MRN	82679	WASHER, LOCK	EA	3
16	30	XBDZZ		FW04H8N	82679	WASHER, FLAT	EA	1
16	31	XBDZZ		MS6005	82679	STIFFENER, PC BOARD	EA	1
16	32	XBDZZ		SCBP04408BN4	82679	SCREW, MACHINE.....	EA	1
16	33	XBDZZ		PC338	82679	PRINTED WIRING BOARD.....	EA	1
16	36	XBDZZ		WA109-43	82679	NUT, PLAIN, HEXAGON	EA	1
16	37	XBDZZ		SC173-0632BIOW	82679	SCREW, MACHINE.....	EA	2
16	40	XBD80		PX829-1	82679	RETAINER, TRANSISTOR.....	EA	7
16	41	PADZZ	5905-00-110-0388	RC07GF104J	81349	RESISTOR, FIXED, COMPOSITION.....	EA	1
16	42	PADZZ		IN627	81349	SEMICONDUCTOR DEVICE, DIODE	EA	5
16	43	PADZZ	5961-00-879-3091	IN755A	81349	SEMICONDUCTOR DEVICE, DIODE	EA	2
16	44	PADZZ	5905-00-135-3973	RC07GF221J	81349	RESISTOR, FIXED, COMPOSITION	EA	1
16	45	PADZZ	5905-00-114-0711	RCOT7GF472J	81349	RESISTOR. FIXED, COMPOSITION.....	EA	2
16	46	PADZZ	5962-00-081-0977	UL914	07263	NETWORK, GATE ELEMENT.....	EA	1
16	47	PADZZ		CMIIICOSO05S	81349	CAPACITOR, FIXED. MICA DIEL	EA	1
16	48	PADZZ	5905-00-116-8556	RC07GF223J	81349	RESISTOR, FIXED. COMPOSITION.....	EA	6
16	49	PADZZ		CC100-40	82679	CAPACITOR, FIXED, CERAMIC DIEL.....	EA	3
16	50	XBDZZ		RGIB8U	80058	CA8LE, RAOI FREQUENCY	EA	1
16	51	PADZZ		62P25K	80740	RESISTOR, VARIABLE, COMPOSITION...	EA	1
16	52	PADZZ	5905-00-106-1356	RCO7GF152J	81349	RESISTOR, FIXED, COMPOSITION.....	EA	2
16	53	PADZZ	5905-00-105-7764	RC07GF222J	81349	RESISTOR, FIXED, COMPOSITION.....	EA	2
16	54	PADZZ	5961-00-022-5664	1N914	81349	SEMICONDUCTOR DEVICE. DIODE	EA	2
16	55	PADZZ	5950-01-013-2481	T216	82679	TRANSFORMER, RADIO FREQ., FIXED ..	EA	1

SECTION II REPAIR PARTS LIST

(1) ILLUSTRATION		(2)	(3)	(4)	(5)	(6)	(7)	(8)
(a) FIG NO.	(b) ITEM NO.	SMR CODE	NATIONAL STOCK NUMBER	PART NUMBER	FSCM	DESCRIPTION USABLE ON CODE	U/M	QTY INC IN UNIT
16	56	XBDZZ,		NT137-0632	82679	NUT, PLAIN, HEXAGON..... EA	2	
16	57	PADZZ	5910-00-939-7396	5815-200Y5U0204Z	18796	CAPACITOR, FIXED, CERAMIC DIEL..... EA	1	
16	58	PADZZ	5950-01-008-2489	TZ218	82679	TRANSFORMER RADIO FREQ., FIXED..... EA	1	
16	59	I PADZZ	5910-00-775-4045	8131M103X5V04Z	18796	CAPACITOR, FIXED, CERAMIC DIEL..... EA	4	
16	60	PADZZ		62P100	80740	RESISTOR, VARIA8BLE.COMPOSITION.. EA	5	
16	61	PADZZ	5950-00-003-4725	WEE220UH	83125	COIL, RADIO FREQUENCY, FIXED EA	1	
16	62	PADZZ		WEE1000UH	83125	COIL, RADIO FREQUENCY, FIXED EA	1	
16	63	PADZZ	5905-00-126-6683	RC07GF332J	81349	RESISTOR, FIXED, COMPOSITION..... EA	1	
16	64	PADZZ	5905-00-118-4559	RC07GF333J	81349	RESISTOR, FIXED, COMPOSITION..... EA	1	
16	65	PADZZ	5905-00-135-6045	RC07GF330J	81349	RESISTOR, FIXED, COMPOSITION..... EA	1	
16	66	XBDZZ		IN236-1 P/O FL1	82679	INSULATOR, FILTER..... EA	1	
						GROUP 03030105 CIRCUIT CARD, MIXER DIVIDER Z105		
17		PAHDD	5820-01-010-4980	A4475	82679	CIRCUIT CO, MIXER DIVIDER 2105..... EA	1	
17	1	PADZZ		0831-00OZ5V00102	18796	CAPACITOR, FIXED, CERAMIC DIEL..... EA	58	
17	2	PADZZ		CM1N1F22IG5S	81349	CAPACITOR, FIXED, MICA DIEL EA	10	
17	3	PADZZ	5905-00-119-3504	RC07GF273J	81349	RESISTOR, FIXED, COMPOSITION..... EA	4	
17	4	PADZZ		CM111COSODSS	81349	CAPACITOR, FIXED, MICA DIEL EA	4	
17	5	PADZZ	5905-00-120-9154	RC07GF471J	81349	RESISTOR, FIXED, COMPOSITION..... EA	2	
17	6	PADZZ	5905-00-135-3971	RC07GF150J	81349	RESISTOR, FIXED, COMPOSITION..... EA	8	
17	7	PADZZ	5905-00-114-0710	RC07GF331J	81349	RESISTOR, FIXED, COMPOSITION..... EA	6	
17	8	PADZZ	5905-00-126-6683	RC07GF332J	81349	RESISTOR, .FIXED, COMPOSITION..... EA	6	
17	9	PADZZ	5905-00-121-9932	RCO7GF391J	81349	RESISTOR, FIXED, COMPOSITION..... EA	4	
17	10	PADZZ		CM111F181G5S	81349	CAPACITOR, FIXED, MICA DIEL EA	2	
17	11	PADZZ	5905-00-114-0711	RC07GF472J	81349	RESISTOR, FIXED, COMPOSITION..... EA	2	
17	12	PADZZ		CM111F131G5S	81349	CAPACITOR, FIXED, MICA DIEL EA	10	
17	13	PADZZ		CM112F152D5S	81349	CAPACITOR, FIXED, MICA DIEL EA	4	
17	14	PADZZ	5905-00-105-7768	RC07GF561J	81349	RESISTOR, FIXED, COMPOSITION..... EA	8	
17	15	PADZZ	5905-00-110-7620	RC07GF102J	81349	RESISTOR, FIXED, COMPOSITION..... EA	12	
17	16	PADZZ		CM111C120J5S	81349	CAPACITOR, FIXED, MICA DIEL EA	41	
17	17	PADZZ	5905-00-110-7622	RC07GF682J	81349	RESISTOR, FIXED, COMPOSITION..... EA	4	
17	18	PADZZ	5905-00-119-3503	RC07GF271J	81349	RESISTOR, FIXED. COMPOSITION..... EA	21	
17	19	PADZZ	5962-00-115-3560	RC07GF183J	81349	RESISTOR, FIXED, COMPOSITION..... EA	2	
17	20	PADZZ	5905-00-135-6046	RC07GF681J	81349	RESISTOR, FIXED, COMPOSITION..... EA	8	
17	21	PADZZ	5905-00-109-8358	RC07GF822J	81349	RESISTOR, FIXED, COMPOSITION..... EA	2	
17	22	PADZZ	5905-00-106-1356	RC07GF152J	81349	RESISTOR, FIXED, COMPOSITION..... EA	2	
17	23	PADZZ	5905-00-119-8812	RC07GF121J	81349	RESISTOR, FIXED, COMPOSITION..... EA	2	
17	24	PADZZ	5905-00-104-8368	RC07GF470J	81349	RESISTOR, FIXED, COMPOSITION..... EA	2	
17	25	PADZZ	5905-00-135-3973	RC07GF221J	81349	RESISTOR, FIXED, COMPOSITION..... EA	2	
17	26	PADZZ	5905-00-110-0388	RC07GF104J	81349	RESISTOR, FIXED. COMPOSITION..... EA	4	

SECTION II REPAIR PARTS LIST

(1) ILLUSTRATION		(2)	(3)	(4)	(5)	(6) DESCRIPTION	(7)	(8)
(a) FIG NO.	(b) ITEM NO.	SMR CODE	NATIONAL STOCK NUMBER	PART NUMBER	FSCM	USABLE ON CODE	U/M	QTY INC IN UNIT
17	27	PADZZ		C112F122J5S	81349	CAPACITOR, FIXED, MICA DIEL EA	4	
17	28	PADZZ		CC100-41	82679	CAPACITOR, FIXED, CERAMIC DIEL..... EA	6	
17	29	PADZZ	5905-00-105-7764	RC07CF222J	81349	RESISTOR, FIXED, COMPOSITION..... EA	4	
17	30	PADZZ	5962-00-106-9344	RC20GF101J	81349	RESISTOR, FIXED, COMPOSITION..... EA	2	
17	31	PADZZ	5962-00-141-0743	RC07GF392J	81349	RESISTOR, FIXED, COMPOSITION..... EA	2	
17	32	PADZZ	5962-00-115-7953	RC07GF180J	81349	RESISTOR, FIXED, COMPOSITION..... EA	2	
17	33	PADZZ	5900-00-106-3666	RC07GF103J	81349	RESISTOR, FIXED, COMPOSITION..... EA	4	
17	34	PADZZ	5905-00-133-0440	RC07GF560J	0 1349	RESISTOR, FIXED, COMPOSITION..... EA	2	
17	35	PADZZ		62P500	80740	RESISTOR, VARIABLE, COMPOSITION... EA	4	
17	36	PADZZ	5950-01-008-8629	TT285-2	82679	TRANSFORMER, RADIO FREQ., ADJ EA	8	
17	37	PADZZ		C1136-6	82679	CORE EA	22	
17	38	PADZZ	5961-00-062-3133	2N3646	81349	TRANSISTOR..... EA	14	
17	39	XBDZZ	5940-00-159-0245	X14578	71279	TERMINAL, STUD..... EA	18	
17	40	PADZZ		MSP051030	13327	SEMICONDUCTOR DEVICE, DIODE EA	4	
17	41	PADZZ	5950-01-006-8293	TT285-17	62679	TRANSFORMER, RADIO FREQ, ADJ EA	2	
17	42	PADZZ	5950-01-006-9907	TT285-3	82679	TRANSFORMER, RADIO FREQ, ADJ EA	14	
17	43	PADZZ		WEE8-2UH	83125	COIL, RADIO FREQUENCY, FIXED EA	2	
17	44	PADZZ	5950-01-008-8630	TT285-4	82679	TRANSFORMER, RADIO FREQ., ADJ EA	8	
17	45	PADZZ	5962-00-481-9523	SN7490N	02195	NETWORK, FREQUENCY DRIVE EA	2	
17	46	PADZZ		WEE15UH	83125	COIL, RADIO FREQUENCY, FIXED EA	2	
17	47	PADZZ	5950-00-003-4725	WEE220UH	83125	COIL, RADIO FREQUENCY, FIXED EA	2	
17	4e	PADZZ	5962-00-995-2310	1N752	81349	SEMICONDUCTOR DEVICE, DIODE EA	2	
17	49	PADZZ	5950-00-344-1863	WEE12OUN	83125	COIL, RADIO FREQUENCY, FIXED EA	3	
17	50	XDHZZ		PC300	82679	PRINTED WIRING BOARD EA	1	
17	51	XBDZZ		MS5011	82679	BRACKET, SHIELD..... EA	7	
17	52	XBDZZ		NTH02568N6	82679	NUT, PLAIN, HEXAGON EA	7	
17	53	XBDZZ		SCBP0256BN4	82679	SCREW, MACHINE..... EA	7	
17	54	XBDZZ		LWE02MRN	82679	WASHER, LOCK EA	7	
17	55	XBDZZ		RG188U	80058	CABLE, RADIO FREQUENCY EA	1	
17	56	XBDZZ		MS6004	82679	STIFFENER, PC BOARD EA	1	
17	57	XBD22		NTNO4408N5	82679	NUT, PLAIN, HEXAGON EA	1	
17	58	XBDZZ		SCBP0440BN5	82679	SCREW, MACHINE..... EA	1	
17	59	XBDZZ		FN04L8N	82679	HASHER, FLAT EA	1	
17	60	PADZZ		LWE04MRN	02679	WASHER, LOCK EA	1	
						GROUP 03030106 CIRCUIT CARD, MIXER DIVIDER Z106		
18		PAHDD		A4479	82679	CIRCUIT CD, MIXER DIVIDER Z106..... EA	1	
18	1	PADZZ		0831-000Z5V00102	18796	CAPACITOR, FIXED, CERAMIC DIEL..... EA	30	
18	1A	PADZZ		C112F122J5S	81349	CAPACITOR, FIXED, MICA DIEL EA	1	
18	2	PADZZ		CK111F221G5S	81349	CAPACITOR, FIXED, MICA DIEL EA	6	

SECTION II REPAIR PARTS LIST

(1) ILLUSTRATION		(2)	(3)	(4)	(5)	(6)	(7)	(8)
(a) FIG NO.	(b) ITEM NO.	SMR CODE	NATIONAL STOCK NUMBER	PART NUMBER	FSCM	DESCRIPTION USABLE ON CODE	U/M	QTY INC IN UNIT
18	3	PADZZ	5905-00-135-3973	RC07GF221J	81349	RESISTOR, FIXED, COMPOSITION..... EA	6	
18	4	PADZZ		CM111C050D5S	81349	CAPACITOR, FIXED MICA DIELECTRIC..... EA	3	
18	5	PADZZ	5950-01-008-8629	TT285-2	82679	TRANSFORMER, RADIO FREQ., ADJ..... EA	4	
18	6	PADZZ		C1136-6	82679	CORE..... EA	12	
18	7	PADZZ	5905-00-120-9154	RC07GF471J	81349	RESISTOR, FIXED, COMPOSITION..... EA	2	
18	8	PADZZ	5905-00-114-5343	RC07GF182J	81349	RESISTOR, FIXED, COMPOSITION..... EA	1	
18	9	XBDZZ	5940-00-159-0245	X1457B	71279	TERMINAL, STUD..... EA	9	
18	10	PADZZ	5905-00-119-8812	C07CF1I21J	81349	RESISTOR, FIXED, COMPOSITION..... EA	2	
18	11	PADZZ	5905-00-126-6688	RC07GFPR2J	81349	RESISTOR, FIXED, COMPOSITION..... EA	1	
18	12	PADZZ	5961-00-062-3133	2N3646	81349	TRANSISTOR..... EA	8	
18	13	PADZZ	5905-00-110-7620	RCOTF102J	81349	RESISTOR, FIXED, COMPOSITION..... EA	3	
18	14	PADZZ		CM111F271F5S	81349	CAPACITOR, FIXED, MICA DIELECTRIC..... EA	1	
18	15	PADZZ	5905-00-106-3666	RC07GF103J	81349	RESISTOR, FIXED, COMPOSITION..... EA	2	
18	16	PADZZ	5950-01-006-9908	TT285-6	82679	TRANSFORMER, RADIO FREQ., ADJ..... EA	1	
18	17	PADZZ	5905-01-036-5107	CM112F152E5S	81349	CAPACITOR, FIXED DIODE MICA DIELECTRIC... EA	2	
18	18	PADZZ	5905-00-114-0711	RC07GF472J	81349	RESISTOR, FIXED, COMPOSITION..... EA	2	
18	19	PADZZ	5905-00-114-0710	RC07GF331J	81349	RESISTOR, FIXED, COMPOSITION..... EA	3	
18	20	PADZZ	5905-00-135-3971	RC07GF150J	81349	RESISTOR, FIXED, COMPOSITION..... EA	2	
18	21	PADZZ	8950-00-344-1863	WEE120UH	83125	COIL, RADIO FREQUENCY, FIXED..... EA	10	
18	22	PADZZ	5905-00-121-9932	RC07CF391J	81349	RESISTOR, FIXED, COMPOSITION..... EA	3	
18	23	PADZZ	5905-00-110-7622	RC07GF682J	81349	RESISTOR, FIXED, COMPOSITION..... EA	3	
18	24	PADZZ		WEE8-2UH	83125	COIL, RADIO FREQUENCY, FIXED..... EA	1	
18	25	PADZZ		TT285-7	82679	TRANSFORMER, RADIO FREQ., ADJ..... EA	1	
18	26	PADZZ	5903-00-104-8368	RC07GF470J	81349	RESISTOR, FIXED, COMPOSITION..... EA	1	
18	27	PADZZ	5930-01-008-8630	TT285-4	82679	TRANSFORMER, RADIO FREQ., ADJ..... EA	4	
18	28	PADZZ		MSP051030	13327	SEMICONDUCTOR DEVICE, DIODE..... EA	4	
18	29	PADZZ		62P500	80740	RESISTOR, VARIABLE, COMPOSITION... EA	2	
18	30	PADZZ	5905-00-133-6046	RC07GF681J	81349	RESISTOR, FIXED, COMPOSITION..... EA	1	
18	31	PADZZ	5905-00-141-0742	RC07GF181J	01349	RESISTOR, FIXED, COMPOSITION..... EA	1	
18	32	PADZZ	5950-01-006-9907	TT285-3	82679	TRANSFORMER, RADIO FREQ., ADJ..... EA	2	
18	33	XBDZZ	5310-00-171-8727	NTH04408N6	82679	NUT, PLAIN, HEXAGON..... EA	1	
18	34	PADZZ		LWE04MRN	82679	WASHER, LOCK..... EA	1	
18	35	XBDZZ		FW04LBN	82679	WASHER, FLAT..... EA	1	
18	36	XBDZZ		HS6004	82679	STIFFENER, PC BOARD..... EA	1	
18	37	XBDZZ		SCBP0440BN5	82679	SCREW, MACHINE..... EA	1	
18	38	XDHZZ		PC302	82679	PRINTED WIRING BOARD..... EA	1	
18	39	PADZZ	5905-00-131-1255	RC07GF122J	81349	RESISTOR, FIXED, COMPOSITION..... EA	2	
18	40	PADZZ	5905-00-119-3503	RC07GF271J	81349	RESISTOR, FIXED, COMPOSITION..... EA	2	
18	41	PADZZ		CM111F131GS	81349	CAPACITOR, FIXED, MICA DIELECTRIC..... EA	4	
18	42	PADZZ	5905-00-106-1278	RC07GF123J	81349	RESISTOR, FIXED, COMPOSITION..... EA	3	

SECTION II REPAIR PARTS LIST

(1) ILLUSTRATION		(2)	(3)	(4)	(5)	(6) DESCRIPTION	(7)	(8)
(a) FIG NO.	(b) ITEM NO.	SMR CODE	NATIONAL STOCK NUMBER	PART NUMBER	FSCM	USABLE ON CODE	U/M	QTY INC IN UNIT
18	43	PADZZ		CM111C120J5S	81349	CAPACITOR, FIXED, MICA DIELECTRIC EA	3	
18	44	PADZZ	5905-00-126-6683	RC07GF332J	81349	RESISTOR, FIXED, COMPOSITION..... EA	1	
18	45	PADZZ	5905-00-105-7768	RC07GF561J	81349	RESISTOR, FIXED, COMPOSITION..... EA	2	
18	46	PADZZ	5905-00-107-0656	RC07GF100J	81349	RESISTOR, FIXED, COMPOSITION..... EA	1	
18	47	PADZZ	5910-00-910-6103	815-016X5V02003I	18796	CAPACITOR, FIXED CERAMIC DIELECTRIC..... EA	6	
18	48	PADZZ	5905-00-106-3668	RC07GF220J	81349	RESISTOR, FIXED, COMPOSITION..... EA	1	
18	49	PADZZ	5910-00-905-6425	538-002-110D	18796	CAPACITOR, VARIABLE, CERAMIC EA	2	
18	50	PADZZ	5961-00-168-2887	IN4864	81349	SEMICONDUCTOR DEVICE, DIODE EA	3	
18	51	PADZZ	5905-00-135-6045	RC07GF330J	81349	RESISTOR, FIXED, COMPOSITION..... EA	1	
18	52	PADZZ	5905-00-116-8554	RC07GF105J	81349	RESISTOR, FIXED, COMPOSITION..... EA	2	
18	53	PADZZ		CM111C201J5S	81349	CAPACITOR, FIXED, MICA DIELECTRIC EA	2	
18	54	PADZZ		CC100-40	82679	CAPACITOR, FIXED, CERAMIC DIELECTRIC..... EA	2	
18	55	PADZZ	5905-00-141-0717	RC07GF473J	81349	RESISTOR, FIXED, COMPOSITION..... EA	1	
18	56	PADZZ	5950-01-035-5726	TT285-18	82679	TRANSFORMER, RADIO FREQ., ADJ EA	1	
18	57	XBDZZ		RG174U	80058	CABLE, RADIO FREQUENCY EA	1	
18	58	PADZZ	5905-00-119-3503	RC07GF271J	81349	RESISTOR, FIXED, COMPOSITION..... EA	1	
18	59	PADZZ	5962-00-481-9677	SN74001	09134	NETWORK, NANDGATE EA	1	
18	60	PADZZ	5905-00-116-8556	RC07GF223J	81349	RESISTOR, FIXED, COMPOSITION..... EA	1	
18	61	PADZZ	5961-00-022-5664	IN914	31349	SEMICONDUCTOR DEVICE, DIODE EA	1	
18	62	PADZZ	5961-00-468-3651	IN751	81349	SEMICONDUCTOR DEVICE, DIODE EA	1	
18	63	PADZZ	5905-00-106-1356	RC07GF152J	81349	RESISTOR, FIXED, COMPOSITION..... EA	1	
18	64	PADZZ	5905-00-109-8358	RC07GF822J	81349	RESISTOR, FIXED, COMPOSITION..... EA	1	
18	65	PADZZ	5905-00-133-0440	RC07GF560J	81349	RESISTOR, FIXED, COMPOSITION..... EA	1	
18	66	PADZZ	5905-00-136-8406	RC07GF242J	81349	RESISTOR, FIXED, COMPOSITION..... EA	1	
18	67	PADZZ	5905-00-105-7764	RC07GP222J	81349	RESISTOR, FIXED, COMPOSITION..... EA	1	
						GROUP 03030107 CIRCUIT CARD, MIXER DIVIDER Z104		
19		PAHDD	5820-01-010-4981	A4487	82679	CIRCUIT CD, MIXER DIVIDER Z104..... EA	1	
19	1	PADZZ		62P500	80740	RESISTOR, VARIABLE, COMPOSITION.. EA	2	
19	2	XBDZZ	5940-00-159-0245	X1457B	71279	TERMINAL, STUD..... EA	10	
19	3	PADZZ		CM112F122F5S	81349	CAPACITOR, FIXED, MICA DIELECTRIC..... EA	2	
19	4	PADZZ	5909-00-119-8812	RC07GF121J	81349	RESISTOR, FIXED, COMPOSITION..... EA	1	
19	5	PADZZ	5950-01-008-8629	TT285-2	82679	TRANSFORMER, RADIO FREQ., ADJ EA	4	
19	6	PADZZ		C1136-6	82679	CORE EA	11	
19	7	PADZZ	5905-00-119-3504	RC07GF273J	81349	RESISTOR, FIXED, COMPOSITION..... EA	3	
19	8	PADZZ		CM111F221J5S	81349	CAPACITOR, FIXED, MICA DIELECTRIC EA	5	
19	9	PADZZ		CM111C050D55	81349	CAPACITOR, FIXED MICA DIELECTRIC EA	2	
19	10	PADZZ	5961-00-062-3133	2N3646	81349	TRANSISTOR..... EA	7	
19	11	PADZZ	5905-00-135-3971	RC07GF150J	81349	RESISTOR, FIXED, COMPOSITION..... EA	4	
19	12	PADZZ		0831-000Z5V00102	18796	CAPACITOR, FIXED, CERAMIC DIELECTRIC..... EA	32	
					18			

SECTION II REPAIR PARTS LIST

(1) ILLUSTRATION		(2)	(3)	(4)	(5)	(6)	(7)	(8)
(a) FIG NO.	(b) ITEM NO.	SMR CODE	NATIONAL STOCK NUMBER	PART NUMBER	FSCM	DESCRIPTION USABLE ON CODE	U/M	QTY INC IN UNIT
19	13	PADZZ	5905-00-126-6683	RC07GF332J	81349	RESISTOR, FIXED, COMPOSITION..... EA	3	
19	14	PADZZ	5905-00-114-0710	RC07GF331J	81349	RESISTOR, FIXED, COMPOSITION..... EA	3	
19	15	PADZZ	5905-00-120-9154	RC07GF471J	81349	RESISTOR, FIXED, COMPOSITION..... EA	1	
19	16	PADZZ	5905-00-121-9932	RC07GF391J	81349	RESISTOR, FIXED, COMPOSITION..... EA	2	
19	17	PADZZ		CM112F152F5S	81349	CAPACITOR, FIXED, MICA DIEL EA	2	
19	18	PADZZ	5905-00-104-8368	RC07GF470J	81349	RESISTOR, FIXED, COMPOSITION..... EA	1	
19	19	PADZZ	5950-01-006-9907	TT285-3	82679	TRANSFORMER, RADIO FREQ., ADJ EA	2	
19	20	PADZZ		WEE8-2UH	83125	COIL, RADIO FREQUENCY, FIXED EA	1	
19	21	PADZZ	5905-00-135-6046	RC07GF 681J	81349	RESISTOR, FIXED, COMPOSITION..... EA	4	
19	22	PADZZ		CM111F131J5S	81349	CAPACITOR, FIXED, MICA DIEL EA	5	
19	23	PADZZ		MSP051030	13327	SEMICONDUCTOR DEVICE. DIODE EA	4	
19	24	PADZZ		CM111C120K5S	81349	CAPACITOR, FIXED, MICA DIEL EA	2	
19	25	PADZZ	5950-01-006-8293	TT285-17	82679	TRANSFORMER, RADIO FREQ., ADJ EA	1	
19	26	PADZZ	5905-00-110-7620	RC07GF102J	11349	RESISTOR, FIXED, COMPOSITION..... EA	6	
19	27	PADZZ	5905-00-110-7622	RC07GF682J	81349	RESISTOR, FIXED, COMPOSITION..... EA	2	
19	28	PADZZ	5950-01-008-8630	TT285-4	82679	TRANSFORMER, RADIO FREQ., ADJ EA	4	
19	29	PADZZ	5905-00-105-7768	RC07GF561J	81349	RESISTOR, FIXED, COMPOSITION..... EA	4	
19	30	PADZZ	5905-00-119-3503	RC07GF271J	81349	RESISTOR, FIXED, COMPOSITION..... EA	1	
19	31	PADZZ		CM111F181G5S	81349	CAPACITOR, FIXED, MICA DIEL EA	1	
19	32	PADZZ	5905-00-114-0711	RC07GF472J	81349	RESISTOR, FIXED, COMPOSITION..... EA	1	
19	33	PADZZ	5962-00-115-7953	RC07GF180J	81349	RESISTOR, FIXED, COMPOSITION..... EA	1	
19	34	PADZZ	5905-00-135-3973	RC07GF221J	81349	RESISTOR, FIXED, COMPOSITION..... EA	1	
19	35	PADZZ	5905-00-105-7764	RC07GF222J	11349	RESISTOR, FIXED, COMPOSITION..... EA	2	
19	36	PADZZ	5905-00-106-3666	RC07GF103J	81349	RESISTOR, FIXED, COMPOSITION..... EA	2	
19	37	PADZZ	5905-00-110-0388	RC07GF104J	81349	RESISTOR, FIXED, COMPOSITION..... EA	2	
19	38	PADZZ	5962-00-141-0743	RC07GF392J	81349	RESISTOR, FIXED, COMPOSITION..... EA	1	
19	39	PADZZ	5950-00-344-1863	WEE120UH	83125	COIL, RADIO FREQUENCY, FIXED EA	2	
19	40	PADZZ	5962-00-995-2310	IN752	81349	SEMICONDUCTOR DEVICE. DIODE EA	1	
19	41	PADZZ	5962-00-106-9344	RC20GF101J	81349	RESISTOR, FIXED, COMPOSITION..... EA	1	
19	42	PADZZ	5950-00-003-4725	WEE220UH	83125	COIL, RADIO FREQUENCY, FIXED EA	1	
19	43	PADZZ		CC100-40	82679	CAPACITOR, FIXED, CERAMIC DIEL..... EA	2	
19	44	PADZZ	5962-00-481-9523	SN7490N	02195	NETWORK, FREQUENCY DRIVE EA	1	
19	45	XBDZZ		RG174U	80038	CABLE, RADIO FREQUENCY EA	1	
19	46	PADZZ		WEE15UH	83125	COIL, RADIO FREQUENCY, FIXED EA	1	
19	47	PADZZ	5905-00-133-0440	RC07GF560J	81349	RESISTOR, FIXED, COMPOSITION..... EA	1	
19	48	PADZZ	5905-00-109-8350	RC07GF822J	81349	RESISTOR, FIXED, COMPOSITION..... EA	1	
19	49	PADZZ	5905-00-106-1356	RC07GF152J	81349	RESISTOR, FIXED, COMPOSITION..... EA	1	
19	50	XDHZZ		PC336	82679	PRINTED WIRING BOARD EA	1	
19	51	XBDZZ		SCBP0256BN4	82679	SCREW., MACHINE EA	4	
19	52	XBDZZ		MS6004	82679	STIFFENER, PC BOARD EA	1	

SECTION II REPAIR PARTS LIST

(1) ILLUSTRATION		(2)	(3)	(4)	(5)	(6)	(7)	(8)
(a) FIG NO.	(b) ITEM NO.	SMR CODE	NATIONAL STOCK NUMBER	PART NUMBER	FSCM	DESCRIPTION USABLE ON CODE	U/M	QTY INC IN UNIT
19	53	XBDZZ		SCBP0440BN5	82679	SCREW, MACHINE..... EA	1	
19	54	XBDZZ		FW04LBN	82679	WASHER, FLAT EA		
19	55	PADZZ		LWE04MRN	82679	WASHER, LOCK EA	1	
19	56	XBDZZ	5310-00-171-8727	NTH0440N6	82679	NUT, PLAIN, HEXAGON EA	1	
19	57	XBDZZ		NTH0256BN6	82679	NUT, PLAIN, HEXAGON EA	4	
19	58	XBDZZ		LWE02MRN	82679	WASHER, LOCK EA	4	
19	59	XBDZZ		MS5011	82679	BRACKET, SHIELD..... EA	4	
						GROUP 03030108		
						CIRCUIT CARD, RADIO FREQUENCY OUTPUT Z115		
20		PAHDD	5820-01-010-4978	A4502	82679	CIRCUIT CD. RADIO FREQ OUTPUT Z115EA	1	
20	1	PADZZ	5910-00-591-2260	0811000X5V00103P	18796	CAPACITOR, FIXED, CERAMIC DIEL..... EA	19	
20	2	PADZZ	5950-00-671-5208	9350-10	74693	COIL, RADIO FREQUENCY, FIXED EA	7	
20	3	PADZZ		315-824A5	09134	CAPACITOR, FIXED, CERAMIC DIEL..... EA	2	
20	4	PADZZ		62P10K	80740	RESISTOR, VARIABLE, COMPOSITION... EA	2	
20	5	PADZZ		NLW20-50	56289	CAPACITOR, FIXED, ELECTROLYTIC EA	1	
20	6	PADZZ		NLW50-50	56289	CAPACITOR, FIXED, ELECTROLYTIC EA	1	
20	7	PADZZ	5961-00-586-5131	2N3375	81349	TRANSISTOR..... EA	1	
20	8	XBDZZ		NTH1032BN10	82679	NUT, PLAIN, HEXAGON EA	1	
20	9	XBDZZ		FW10HBN	82679	WASHER, FLAT EA	1	
20	10	XBDZZ		LWE10MRN	82679	WASHER, LOCK EA	1	
20	11	PADZZ	5962-00-106-9344	RC20G101J	81349	RESISTOR, FIXED, COMPOSITION..... EA	2	
20	12	PADZZ		62P5000	80740	RESISTOR, VARIABLE, COMPOSITION... EA		
20	13	PADZZ	5905-00-121-9861	RC32GF102J	81349	RESISTOR, FIXED, COMPOSITION..... EA		
20	14	PADZZ		2N5070	81349	TRANSISTOR..... EA	1	
20	15	XBDZZ		NTH1032BN10	82679	NUT, PLAIN, HEXAGON EA	1	
20	16	XBDZZ		FW10HBN	82679	WASHER, FLAT EA	1	
20	17	XBDZZ		LWE10MRN	82679	WASHER, LOCK EA	1	
20	18	PADZZ	5901-00-114-1146	RC20GF222J	91349	RESISTOR, FIXED, COMPOSITION..... EA	1	
20	19	PADZZ		NLW50-15	56289	CAPACITOR, FIXED, ELECTROLYTIC EA	1	
20	20	PADZZ	5961-00-686-6720	1N100	81349	SEMICONDUCTOR DEVICE, DIODE EA	2	
20	21	PADZZ	5950-01-008-2487	TZ219	82679	TRANSFORMER, RADIO FREQ, FIXED ... EA	1	
20	22	XBDZZ		NT137-0832	82679	NUT, PLAIN, HEXAGON EA	3	
20	23	PAFZZ		NT137-1032	82679	NUT, PLAIN, HEXAGON		
20	24	XBDZZ		WA109-52	82679	NUT, PLAIN, HEXAGON EA	2	
20	25	XBDZZ		SC143-0832B12W	82679	SCREW, MACHINE EA	1	
20	26	XBDZZ		CF105-06	95566	CORE, TOROID EA	3	
20	27	PADZZ		0831-000Z5V00102	18796	CAPACITOR, FIXED, CERAMIC DIEL..... EA	2	
20	28	PADZZ	5905-00-141-0594	RC20GF473J	81349	RESISTOR, FIXED, COMPOSITION..... EA	1	
20	29	PADZZ		WEE2-2UH	83125	COIL, RADIO FREQUENCY, FIXED EA	1	
20	30	PADZZ		1N4864	81349	SEMICONDUCTOR DEVICE, DIODE EA	1	
					20			

SECTION II REPAIR PARTS LIST

(1) ILLUSTRATION		(2)	(3)	(4)	(5)	(6) DESCRIPTION	(7)	(8)
(a) FIG NO.	(b) ITEM NO.	SMR CODE	NATIONAL STOCK NUMBER	PART NUMBER	FSCM	USABLE ON CODE	U/M	QTY INC IN UNIT
20	31	PADZZ	5950-00-344-1863	WEE120UH	83125	COIL, RADIO FREQUENCY, FIXED EA	9	
20	32	PADZZ	5905-00-104-8350	RC20GF221J	81349	RESISTOR, FIXED, COMPOSITION..... EA	1	
20	33	PADZZ	5905-00-110-0196	RC20GF102J	81349	RESISTOR, FIXED, COMPOSITION..... EA	3	
20	34	PADZZ	5905-00-114-5430	RC20GF433J	81349	RESISTOR, FIXED, COMPOSITION..... EA	1	
20	35	PADZZ	5905-00-104-5755	RC20GF100J	81349	RESISTOR, FIXED, COMPOSITION..... EA	1	
20	36	PADZZ		CM111F621D5S	81349	CAPACITOR, FIXED, MICA DIEL EA	1	
20	37	PADZZ	5950-00-671-5208	9350-10	74693	COIL, RADIO FREQUENCY, FIXED EA	1	
20	38	PADZZ	5905-00-114-5388	RC20GF220J	81349	RESISTOR, FIXED, COMPOSITION..... EA	2	
20	39	PADZZ	5905-00-111-4734	RC20GF470J	81349	RESISTOR, FIXED, COMPOSITION..... EA	1	
20	40	PADZZ		CL240-5R6	82679	COIL, RADIO FREQUENCY, FIXED EA	1	
20	41	PADZZ		22T3R9-000K	68995	COIL, RADIO FREQUENCY, FIXED EA	1	
20	42	PADZZ		CM112F112G5S	81349	CAPACITOR, FIXED, MICA DIEL EA	1	
20	43	PADZZ		CM112F222G5S	81349	CAPACITOR, FIXED, MICA DIEL EA	1	
20	44	PADZZ	5950-01-012-8032	TZ220	82679	TRANSFORMER, RADIO FREQ., FIXED .. EA	1	
20	45	XBDZZ		SC143-0832B8W	82679	SCREW, MACHINE..... EA	1	
20	46	PADZZ	5961-00-939-4226	2N3296	81349	TRANSISTOR..... EA	1	
20	47	PADZZ	5905-00-104-8348	RC20GF332J	81349	RESISTOR, FIXED, COMPOSITION..... EA	1	
20	48	PADZZ	5905-00-141-1116	RC20GF562J	81349	RESISTOR, FIXED, COMPOSITION..... EA	1	
20	49	XBDZZ		NTH0632BN8	82679	NUT. PLAIN, HEXAGON EA	1	
20	50	XBOZZ		FW06HBN	82679	WASHER, FLAT EA	12	
20	51	XBOZZ		LWE06MRN	82679	WASHER, LOCK EA	1	
20	52	XBDZZ		SCBP0440BN5	82679	SCREW, MACHINE..... EA	1	
20	53	XBDZZ		FW04LBN	82679	WASHER, FLAT EA	1	
20	53A	XBFZZ		MS6017	82679	HEAT SINK AND PC BOARD HOLDER..... EA	1	
20	54	PADZZ		LWE04MRN	82679	WASHER, LOCK EA	1	
20	55	PADZZ	5999-01-035-5788	HD107	82679	HEATSINK, ELEC CMPNT..... EA	1	
20	56	XBDZZ		NTH0256BN6	82679	NUT, PLAIN, HEXAGON EA	1	
20	57	XBDZZ		SCBP0256BN6	82679	SCREW, MACHINE..... EA	1	
20	58	XADZZ		LWE02MRN	82679	WASHER, LOCK EA	1	
20	59	XDHZZ		PC306	82679	PRINTED WIRING BOARD EA	1	
21		PADZZ	5895-01-010-4982	A4533	82679	GROUP 03030109 CIRCUIT CD, RISER CIRCUIT CD, RISER..... EA	1	
21	1	XBHZZ		JJ319A15DPE	82679	CONNECTOR, RECEPTACLE, ELEC EA	1	
21	2	XDHZZ		PC305	82679	PRINTED WIRING BOARD..... EA	1	
22		PAHHD	5820-01-010-4982	A4524	82679	GROUP 03030110 CIRCUIT CARD, SIDEBAND GENERATOR Z107 CIRCUIT CD, SIDEBAND, GENERATOR Z107 EA	1	
22	1	PADZZ	5905-00-110-7620	RC07GF102J	81349	RESISTOR, FIXED, COMPOSITION..... EA	17	
22	2	PADZZ	5960-00-069-4624	1N541	81349	SEMICONDUCTOR DEVICE, DIODE EA	8	
22	3	PADZZ	5910-00-775-4045	8131M103X5V0104Z	18796	CAPACITOR, FIXED, CERAMIC DIEL..... EA	25	
					21			

SECTION II REPAIR PARTS LIST

(1) ILLUSTRATION		(2)	(3)	(4)	(5)	(6)	(7)	(8)
(a) FIG NO.	(b) ITEM NO.	SMR CODE	NATIONAL STOCK NUMBER	PART NUMBER	FSCM	DESCRIPTION USABLE ON CODE	U/M	QTY INC IN UNIT
22	4	PADZZ	5905-00-106-3666	RC07GF103J	81349	RESISTOR, FIXED, COMPOSITION..... EA	12	
22	5	PADZZ	5905-00-119-3504	RC07GF273J	81349	RESISTOR, FIXED, COMPOSITION..... EA	2	
22	6	PADZZ		62P100	80740	RESISTOR, VARIABLE, COMPOSITION... EA	4	
22	7	PADZZ	5961-00-062-3133	2N3646	81349	TRANSISTOR..... EA	13	
22	8	XBDZZ	5940-00-159-0245	X1457B	71279	TERMINAL, STUD..... EA	10	
22	9	PADZZ	5905-00-120-9154	RC07GF471J	81349	RESISTOR, FIXED, COMPOSITION..... EA	10	
22	10	PADZZ	5950-01-006-9911	TT285-11	82679	TRANSFORMER, ADJUSTABLE EA	2	
22	11	XBDZZ		C1136-5	82679	CORE EA	2	
22	12	PADZZ	5905-00-118-4559	RC07GF333J	81349	RESISTOR, FIXED, COMPOSITION..... EA	41	
22	13	PADZZ		CM112F392F5S	81349	CAPACITOR, FIXED, MICA DIEL..... EA	21	
22	14	PADZZ		WEE3300UH	83125	COIL, RADIO FREQUENCY FIXED..... EA	2	
22	15	PADZZ	5905-00-106-1356	RC07GF152J	81349	RESISTOR, FIXED, COMPOSITION..... EA	2	
22	16	PADZZ		NLW2-50	56289	CAPACITOR, FIXED, ELECTROLYTIC EA	2	
22	17	PADZZ	5905-00-141-0717	RC07GF473J	81349	RESISTOR, FIXED, COMPOSITION..... EA	2	
22	18	PADZZ		NLW10-25	56289	CAPACITOR, FIXED, ELECTROLYTIC EA	11	
22	19	PADZZ	5905-00-116-8555	RC07GF153J	81349	RESISTOR, FIXED, COMPOSITION..... EA	3	
22	20	PADZZ		805031X5V103M	18796	CAPACITOR, FIXED, CERAMIC DIEL..... EA	2	
22	21	PADZZ	5915-01-016-8190	FX270	82679	FILTER, BYPASS..... EA	1	
22	22	XBDZZ	5310-00-171-8927	NTH0440BN6	82679	NUT, PLAIN, HEXAGON..... EA	1	
22	23	XBDZZ		FW04LBN	82679	WASHER, FLAT EA	1	
22	24	PADZZ		LWE04MRN	82679	WASHER, LOCK EA	1	
22	25	XBHZZ		1M236-2	82679	INSULATOR., FILTER..... EA	1	
22	26	PADZZ	5905-00-131-1255	RC07GF122J	81349	RESISTOR, FIXED, COMPOSITION..... EA	4	
22	27	PADZZ	5905-00-141-1183	RC07GF101J	81349	RESISTOR, FIXED, COMPOSITION..... EA	4	
22	28	PADZZ	5915-01-019-0990	FX269	82679	FILTER, BYPASS..... EA	1	
22	29	XBDZZ	5310-00-171-8727	NTH0440BN6	82679	NUT, PLAIN, HEXAGON..... EA	1	
22	30	XBDZZ		FW04LBN	82679	WASHER, FLAT EA	1	
22	31	PADZZ		LWE04MRN	82679	WASHER, LOCK EA	1	
22	32	XBHZZ		IM236-2	82679	INSULATOR, FILTER..... EA	1	
22	33	XDHZZ		PC337	82679	PRINTED WIRING BOARD..... EA	1	
22	34	XBDZZ		NS6004	82679	STIFFENER, PC BOARD..... EA	1	
22	35	XBDZZ	5310-00-171-8727	NTH0440BN6	82679	NUT, PLAIN, HEXAGON..... EA	1	
22	36	XBDZZ		SCBPO440BN5	82679	SCREW, MACHINE..... EA	1	
22	37	XBDZZ		FW04LBN	82679	WASHER, FLAT EA	1	
22	38	PADZZ		LWE04MRN	82679	WASHER, LOCK..... EA	1	
22	39	PADZZ		CC100-41	82679	CAPACITOR, FIXED, CERAMIC DIEL..... EA	6	
22	40	PADZZ		CM111F151F5S	81349	CAPACITOR, FIXED, MICA DIEL EA	2	
22	41	PADZZ		538-002-112F	18796	CAPACITOR, VARIABLE, CERAMIC..... EA	2	
22	42	PADZZ		UTCDIT260	80223	TRANSFORMER, AUDIO FREQUENCY ... EA	2	
22	43	PADZZ		NLWSO-50	56289	CAPACITOR, FIXED, ELECTROLYTIC EA	1	
					22			

SECTION II REPAIR PARTS LIST

(1) ILLUSTRATION		(2)	(3)	(4)	(5)	(6)	(7)	(8)
(a) FIG NO.	(b) ITEM NO.	SMR CODE	NATIONAL STOCK NUMBER	PART NUMBER	FSCM	DESCRIPTION USABLE ON CODE	U/M	QTY INC IN UNIT
22	44	PADZZ	5905-00-116-8556	RC07GF223J	81349	RESISTOR, FIXED, COMPOSITION..... EA	2	
22	45	PADZZ		62P10K	80740	RESISTOR, VARIABLE, COMPOSITION... EA	1	
22	46	PADZZ	5905-00-106-1357	RCOTGF563J	81349	RESISTOR, FIXED, COMPOSITION..... EA	2	
22	47	PADZZ	5905-00-105-7767	RC07GF474J	81349	RESISTOR, FIXED, COMPOSITION..... EA	1	
22	48	PADZZ		CM111C220J5S	81349	CAPACITOR, FIXED, MICA DIEL EA	1	
22	49	PADZZ	5995-00-110-0388	RC07GF104J	81349	RESISTOR, FIXED, COMPOSITION..... EA	1	
22	50	PADZZ	5950-00-003-4725	WEE220UH	83125	COIL, RADIO FREQUENCY, FIXED EA	11	
22	51	PADZZ		NLW75-15	56289	CAPACITOR, FIXED, ELECTROLYTIC EA	1	
22	52	PADZZ	5905-00-135-3973	RC07GF221J	81349	RESISTOR, FIXED, COMPOSITION..... EA	1	
22	53	PADZZ		WEE1000UH	83125	COIL, RADIO FREQUENCY, FIXED EA	1	
						GROUP 03030111 CIRCUIT CARD, SPECTRUM GENERATOR Z101		
23		PAHHD	5820-01-010-4987	A4480	82679	CIRCUIT CD, SPECTRUM GEN Z101 EA	1	
23	1	PBDZZ	5910-00-910-6103	815-016X5V02003I	18796	CAPACITOR, FIXED, CERAMIC DIEL EA	3	
23	2	PBDZZ	5910-00-591-2260	0811000X5V00103P	18796	CAPACITOR, FIXED, CERAMIC DIEL EA	35	
23	3	PBDZZ	5950-00-344-1863	WEE120UH	83125	COIL, RADIO FREQUENCY FIXED EA	15	
23	4	PADZZ		CM111C200J5S	81349	CAPACITOR, FIXED, MICA DIEL EA	1	
23	5	XBDZZ	5940-00-159-0245	X1457B	71279	TERMINAL, STUD..... EA	9	
23	6	PBDZZ		CM111F271F5S	81349	CAPACITOR, FIXED. MICA DIEL EA	2	
23	7	PBDZZ		0831-000Z5V00102	18796	CAPACITOR, FIXED, CERAMIC DIEL EA	14	
23	8	PBDZZ	5910-00-905-6425	538-002-1100	18796	CAPACITOR, VARIABLE, CERAMIC..... EA	8	
23	9	PBDZZ		CM111F321D5S	81349	CAPACITOR, FIXED, MICA DIEL EA	2	
23	10	PBDZZ		CM111F221G5S	81349	CAPACITOR, FIXED, MICA DIEL EA	2	
23	11	PBDZZ		CM111F431G5S	81349	CAPACITOR, FIXED, MICA DIEL EA	2	
23	12	PBDZZ		538-006-112F	18796	CAPACITOR, VARIABLE, CERAMIC..... EA	1	
23	13	PBDZZ		C111E820F5S	81349	CAPACITOR, FIXED, MICA DIEL EA	1	
23	14	PBDZZ		WEE12UH	83125	COIL, RADIO FREQUENCY, FIXED EA	1	
23	15	PBDZZ	5915-01-006-8310	CL419	82679	COIL, RADIO FREQUENCY FIXED EA	1	
23	15A	PADZZ	5905-00-498-5786	RC32GF226J	81349	RESISTOR, FIXED COMPOSITION..... EA	1	
23	16	PADZZ		CM111F101J5S	81349	CAPACITOR FIXED MICA DIEL EA	1	
23	17	PBDZZ		CM111F181G5S	81349	CAPACITOR, FIXED, MICA DIEL EA	1	
23	s18	PBDZZ	5910-00-939-7396	5815-200Y5U0204Z	18796	CAPACITOR, FIXED, CERAMIC DIEL EA	3	
23	19	PADZZ		0861-000X5R00101	18796	CAPACITOR, FIXED, CERAMIC DIEL EA	1	
23	20	P8DZ		CM112F272D5S	81349	CAPACITOR, FIXED. MICA DIEL EA	1	
23	21	PA8ZZ	5905-00-109-8358	RC07GF822J	81349	RESISTOR, FIXED, COMPOSITION..... EA	5	
23	22	P602Z	5905-00-141-0742	RC07GF181J	81349	RESISTOR, FIXED, COMPOSITION..... EA	2	
23	23	PADZZ	5905-00-110-7620	RC07GF102J	81349	RESISTOR, FIXED, COMPOSITION..... EA	11	
23	24	PA0ZZ	5905-00-106-3666	RC07GF103J	81349	RESISTOR, FIXED, COMPOSITION..... EA	6	
23	25	P80ZZ	5961-00-062-3133	2N3646	81349	TRANSISTOR..... EA	17	
23	26	PADZZ	5905-00-118-4559	RC07GF333J	81349	RESISTOR, FIXED, COMPOSITION..... EA	1	
					23			

SECTION II REPAIR PARTS LIST

(1) ILLUSTRATION		(2)	(3)	(4)	(5)	(6) DESCRIPTION	(7)	(8)
(a) FIG NO.	(b) ITEM NO.	SMR CODE	NATIONAL STOCK NUMBER	PART NUMBER	FSCM	USABLE ON CODE	U/M	QTY INC IN UNIT
23	27	PADZZ	5905-00-104-8368	RC07GF470J	81349	RESISTOR, FIXED, COMPOSITION..... EA	5	
23	28	PADZZ	5950-01-006-8330	TT286-L15	82679	TRANSFORMER, RADIO FREQ, ADJ..... EA	3	
23	29	XBDZZ		C1136-5	82679	CORE..... EA	9	
23	30	PADZZ	5905-00-119-3503	RCO7GF271J	81349	RESISTOR, FIXED, COMPOSITION..... EA	3	
23	31	PADZZ	5950-01-008-8626	TT286-16	82679	TRANSFORMER, RADIO FREQ., ADJ..... EA	3	
23	32	PADZZ	5905-00-105-7767	RC07GF474J	81349	RESISTOR, FIXED, COMPOSITION..... EA	4	
23	33	PADZZ	5905-00-141-1183	RC07GF101J	81349	RESISTOR, FIXED, COMPOSITION..... EA	5	
23	34	PADZZ	5955-01-035-5236	CR109-134	82679	CRYSTAL UNIT, QUARTZ..... EA	1	
23	35	PADZZ	5905-00-126-6683	RC07GF332J	81349	RESISTOR, FIXED, COMPOSITION..... EA	4	
23	36	PADZZ	5905-00-116-8555	RC07GF153J	81349	RESISTOR, FIXED, COMPOSITION..... EA	4	
23	37	PADZZ	5905-01-035-5235	CR109-124	82679	CRYSTAL UNIT, QUARTZ..... EA	1	
23	38	PADZZ	5905-00-105-7768	RC07GF561J	81349	RESISTOR, FIXED, COMPOSITION..... EA	4	
23	39	PADZZ	5955-01-035-5237	CR109-138	82679	CRYSTAL UNIT, QUARTZ..... EA	1	
23	40	PADZZ	5955-01-035-5234	CR109-104	82679	CRYSTAL UNIT, QUARTZ..... EA	1	
23	41	PADZZ	5950-01-006-8299	TT7286-14	82679	TRANSFORMER, RADIO FREQ., ADJ..... EA	1	
23	42	PADZZ	5905-00-121-9932	RC07GF391J	81349	RESISTOR, FIXED, COMPOSITION..... EA	1	
23	43	PADZZ	5905-00-113-4860	RC07GF270J	81349	RESISTOR, FIXED, COMPOSITION..... EA	1	
23	44	PADZZ	5905-00-111-4727	RC07GF272J	81349	RESISTOR, FIXED COMPOSITION..... EA	1	
23	45	PA0ZZ	5905-00-114-0711	RC07GF472J	81349	RESISTOR, FIXED, COMPOSITION..... EA	2	
23	46	PADZZ	5950-01-008-2490	TZ222	82679	TRANSFORMER, RADIO FREQ. FIXED .. EA	1	
23	47	PADZZ	5905-00-498-5786	RC32GF226J	81349	RESISTOR, FIXED, COMPOSITION..... EA	1	
23	48	PADZZ	5905-00-110-0388	RC0GF104J	81349	RESISTOR, FIXED, COMPOSITION..... EA		
23	49	XBDZZ		RG188U	80058	CABLE, RADIO FREQUENCY..... EA		
23	50	PADZZ	5905-00-105-7764	RC07GF222J	81349	RESISTOR, FIXED. COMPOSITION..... EA	2	
23	51	PADZZ	5962-00-141-0743	RC07GF392J	81349	RESISTOR, .FIXED, COMPOSITION..... EA	1	
23	52	PADZZ	5961-00-892-3361	IN750A	81349	SEMICONDUCTOR DEVICE, DIODE..... EA	1	
23	53	PADZZ	5905-00-141-0726	RC32GF181J	81349	RESISTOR, FIXED COMPOSITION..... EA	1	
23	54	PADZZ		62P5000	80740	RESISTOR, VARIABLE, COMPOSITION... EA	1	
23	55	PADZZ	5050-01-006-8295	TT286-2	82679	TRANSFORMER, RADIO FREQ, ADJ..... EA	1	
23	56	XBDZZ		MS6004	82679	STIFFENER, PC BOARD..... EA	1	
23	57	XBDZZ	5310-00-171-8727	NTH0440BN6	82679	NUT, PLAIN, HEXAGON..... EA	3	
23	58	XBDZZ		SCBPO440BN5	82679	SCREW, MACHINE..... EA	3	
23	59	XBDZZ		FW04LBN	02679	HASHER, FLAT..... EA	3	
23	60	PADZZ		LWE04MRN	82679	WASHER, LOCK..... EA	3	
23	61	XDHZZ		PC383	82679	PRINTED WIRING BOARD..... EA	1	
23	62	PADZZ	5905-00-114-0710	RC07GF331J	81349	RESISTOR, FIXED COMPOSITION..... EA	1	
23	63	PADZZ		UX5995829X	07263	NETWORK, DECADE COUNTER..... EA	1	
						GROUP 03030112		
24		PAHDD	5820-01-010-4983	A4478	82679	CIRCUIT CARD, STEP GENERATOR A Z110		
24	1	PADZZ		0831-000Z5V00102	18796	CIRCUIT CD, STEP GEN A 2110..... EA	1	
						CAPACITOR, FIXED CERAMIC DIELECT..... EA	68	

SECTION II REPAIR PARTS LIST

(1) ILLUSTRATION		(2)	(3)	(4)	(5)	(6) DESCRIPTION	(7)	(8)
(a) FIG NO.	(b) ITEM NO.	SMR CODE	NATIONAL STOCK NUMBER	PART NUMBER	FSCM	USABLE ON CODE	U/M	QTY INC IN UNIT
24	2	PADZZ	5961-00-062-3133	2N3646	81349	TRANSISTOR	EA	15
24	3	PADZZ		CM111050D5S	81349	CAPACITOR, FIXED, MICA DIEI	EA	12
24	4	PADZZ		CM111F121G5S	81349	CAPACITOR, FIXED, MICA DIEI	EA	13
24	5	PADZZ		CC100-40	82679	CAPACITOR, FIXED, CERAMIC DIEI	EA	8
24	6	PADZZ		MSP051030	13327	SEMICONDUCTOR DEVICE, DIODE	EA	4
24	7	PADZZ	5961-00-022-5664	1N914	81349	SEMICONDUCTOR DEVICE, DIODE	EA	8
24	8	PADZZ		CM11E470GSS	81349	CAPACITOR, FIXED, MICA DIEI	EA	2
24	9	PADZZ		CM111F151F5S	81349	CAPACITOR, FIXED, MICA DIEI	EA	13
24	10	PADZZ		CM111F621D5S	81349	CAPACITOR, FIXED, MICA DIEI	EA	4
24	11	PADZZ		0861-000X5R00101	18796	CAPACITOR, FIXED, CERAMIC DIEI	EA	1
24	12	PADZZ	5910-00-775-4045	813M103XSV01042	18796	CAPACITOR, FIXED, CERAMIC DIEI	EA	6
24	13	XBDZZ		RG188U	80058	CABLE, RADIO FREQUENCY	EA	1
24	14	PADZZ		CM111E680J5S	81349	CAPACITOR, FIXED, MICA DIEI	EA	2
24	15	PADZZ	5950-00-144-1863	WEE120UH	83125	COIL, RADIO FREQUENCY, FIXED	EA	16
24	16	PADZZ	5905-00-119-8768	RC0GF821J	81349	RESISTOR, FIXED, COMPOSITION	EA	4
24	17	PADZZ	5905-00-109-1358	RC0GP822J	81349	RESISTOR, FIXED, COMPOSITION	EA	11
24	18	PADZZ	5905-00-114-0710	RC0TGF33J	81349	RESISTOR, FIXED, COMPOSITION	EA	11
24	19	PADZZ	5905-00-119-8812	RC0GF121J	81349	RESISTOR, FIXED, COMPOSITION	EA	9
24	20	PADZZ	5950-00-034-8141	TT287-14	82679	TRANSFORMER, RADIO FREQ, ADJ	EA	4
24	21	PADZZ		C1136-6	82679	CORE	EA	29
24	22	PADZZ	5905-00-106-3668	RC07GF220J	81349	RESISTOR, FIXED, COMPOSITION	EA	4
24	23	PADZZ	5905-00-114-5343	RC0TGF182J	81349	RESISTOR, FIXED, COMPOSITION	EA	12
24	24	PADZZ	5905-00-110-7620	RC07GF102J	81349	RESISTOR, FIXED, COMPOSITION	EA	11
24	25	PADZZ	5950-01-034-9338	TT287-13	82679	TRANSFORMER, RADIO FREQ, ADJ	EA	6
24	26	PADZZ	5905-00-135-3971	RC07GF150J	81349	RESISTOR, FIXED, COMPOSITION	EA	4
24	27	PADZZ	5950-01-006-8300	TT287-15	82679	TRANSFORMER, RADIO FREQ, ADJ	EA	2
24	28	PADZZ	5905-00-141-0742	RC070TGF1J	81349	RESISTOR, FIXED, COMPOSITION	EA	8
24	29	PADZZ	5950-01-006-8305	TT287-19	82679	TRANSFORMER, RADIO FREQ, ADJ	EA	2
24	30	PADZZ		62P500	80740	RESISTOR, VARIABLE, COMPOSITION	EA	2
24	31	PADZZ	5905-00-141-1118	RC07GF101J	81349	RESISTOR, FIXED, COMPOSITION	EA	12
24	32	PADZZ	5905-01-006-8360	TT287-20	82679	TRANSFORMER, RADIO FREQ, ADJ	EA	4
24	33	PADZZ	5905-00-113-4860	RC07GF270J	81349	RESISTOR, FIXED, COMPOSITION	EA	4
24	34	PADZZ	5905-00-106-1278	RC07GF123J	81349	RESISTOR, FIXED, COMPOSITION	EA	4
24	35	PADZZ	5950-01-017-0209	TT287-4	82679	TRANSFORMER, RADIO FREQ, ADJ	EA	4
24	36	PADZZ	5950-01-006-8301	TT287-3	82679	TRANSFORMER, RADIO FREQ, ADJ	EA	6
24	37	PADZZ	5905-00-104-8360	RC07GF470J	81349	RESISTOR, FIXED, COMPOSITION	EA	2
24	38	PADZZ	5905-00-135-3975	RC07GF610J	81349	RESISTOR, FIXED, COMPOSITION	EA	3
24	39	PADZZ		62P100	80740	RESISTOR, VARIABLE, COMPOSITION	EA	3
24	40	PADZZ	5950-01-009-9034	TZ221	82679	TRANSFORMER, RADIO FREQ, FIXED	EA	1
24	41	XBDZZ		CF105-06	95366	CORE, TOROID	EA	1

SECTION II REPAIR PARTS LIST

(1) ILLUSTRATION		(2)	(3)	(4)	(5)	(6) DESCRIPTION	(7)	(8)	
(a) FIG NO.	(b) ITEM NO.	SMR CODE	NATIONAL STOCK NUMBER	PART NUMBER	FSCM	USABLE ON CODE	U/M	QTY INC IN UNIT	
24	42	PADZZ	5905-00-107-0656	WEE12UH	83125	COIL, RADIO FREQUENCY, FIXED	EA	2	
24	43	PADZZ		RC076GF100J	81349	RESISTOR, FIXED, COMPOSITION	EA	1	
24	44	PADZZ		WEE2200UH	83125	COIL, RADIO FREQUENCY, FIXED	EA	2	
24	45	XBDZZ		MS6004	82679	STIFFENER, PC BOARD	EA	1	
24	46	XBDZZ		NTH0440BN5	82679	NUT, PLAIN, HEXAGON	EA	1	
24	47	XBDZZ		SCBP0440BN5	82679	SCREW, MACHINE	EA	1	
24	48	XBDZZ		FW04LBN	82679	WASHER, FLAT	EA	1	
24	49	PADZZ		LWE04MRN	82679	WASHER, LOCK	EA	1	
24	50	XDHZZ		PC301	82679	PRINTED WIRING BOARD	EA	1	
						GROUP 03030113 CIRCUIT CARD, STEP GENERATOR B Z111			
25		PAHDD	5820-01-010-4984	A4504	82679	CIRCUIT CD, STEP GENERATOR B Z111	EA	1	
25	1	PADZZ	5905-00-135-3975	0861-000X5R00101	18796	CAPACITOR, FIXED, CERAMIC DIEL	EA	12	
25	2	PADZZ		RC07GF680J	81349	RESISTOR, FIXED, COMPOSITION	EA	6	
25	3	PADZZ		0831-0000Z5V00102	18796	CAPACITOR, FIXED, CERAMIC DIEL	EA	41	
25	4	PADZZ		5950-01-017-1791	TZ215-12	82679	TRANSFORMER, RADIO FREQ, FIXED	EA	9
25	5	PADZZ		5905-00-104-8330	RC20GF333J	81349	RESISTOR, FIXED, COMPOSITION	EA	9
25	6	PADZZ		538-002-112F	18796	CAPACITOR, VARIABLE, CERAMIC	EA	6	
25	7	PADZZ		5905-00-109-8358	RC07GF822J	81349	RESISTOR, FIXED, COMPOSITION	EA	3
25	8	PADZZ		5905-00-114-0710	RC07GF331J	81349	RESISTOR, FIXED, COMPOSITION	EA	6
25	9	PADZZ		5905-00-110-7620	RC07GF102J	81349	RESISTOR, FIXED, COMPOSITION	EA	6
25	10	PADZZ		5950-00-627-3107	WEE10UH	83125	COIL, RADIO FREQUENCY, FIXED	EA	3
25	11	PADZZ	5950-00-344-1863	WEE120UH	83125	COIL, RADIO FREQUENCY, FIXED	EA	1	
25	12	PADZZ	5915-01-016-8234	FX282	82679	FILTER, BANDPASS	EA	1	
25	13	PADZZ	5915-01-019-0989	WEE47UH	83125	COIL, RADIO FREQUENCY, FIXED	EA	3	
25	14	PADZZ		FX280	82679	FILTER, BANDPASS	EA	1	
25	15	PADZZ		831-000X5P0-471K	18796	CAPACITOR, FIXED, CERAMIC DIEL	EA	3	
25	16	PADZZ		5915-01-016-8233	FX281	82679	FILTER, BANDPASS	EA	1
25	17	PADZZ		5905-00-107-0656	RC07GF100J	81349	RESISTOR, FIXED, COMPOSITION ;	EA	61
25	18	PADZZ		5691-00-062-3133	2N3646	81349	TRANSISTOR	EA	9
25	19	PADZZ		5905-00-106-3666	RC07GF103J	81349	RESISTOR, FIXED, COMPOSITION	EA	3
25	20	PADZZ		5905-00-119-8811	RC07GF151J	81349	RESISTOR, FIXED, COMPOSITION	EA	6
25	21	PADZZ		5910-00-905-6425	538-002-1100	18796	CAPACITOR, VARIABLE, CERAMIC	EA	3
25	22	PADZZ		5905-00-141-0744	RC07GF562J	81349	RESISTOR, FIXED, COMPOSITION	EA	3
25	23	PADZZ	5905-00-115-8055	RC07GF393J	81349	RESISTOR, FIXED, COMPOSITION	EA	3	
25	24	PADZZ	5962-00-141-0743	RC07GF392J	81349	RESISTOR, FIXED, COMPOSITION	EA	3	
25	25	PADZZ		CN111F471J5S	81349	CAPACITOR, FIXED, MICA DIEL	EA	2	
25	26	PADZZ		CN111F820J5S	81349	CAPACITOR, FIXED, MICA DIEL	EA	1	
25	27	PADZZ		WEE47UH	83125	COIL, RADIO FREQUENCY, FIXED	EA	1	
25	28	XBDZZ		RG188U	80058	CABLE, RADIO FREQUENCY	EA	1	

SECTION II REPAIR PARTS LIST

(1) ILLUSTRATION		(2)	(3)	(4)	(5)	(6) DESCRIPTION	(7)	(8)
(a) FIG NO.	(b) ITEM NO.	SMR CODE	NATIONAL STOCK NUMBER	PART NUMBER	FSCM	USABLE ON CODE	U/M	QTY INC IN UNIT
25	29	XBDZZ	5310-00-171-8727	8X227	82679	COVER, SHIELD RADIO FREQUENCY	EA	1
25	30	XBDZZ		NTH04400BN6	82679	NUT, PLAIN, HEXAGON	EA	6
25	31	XBDZZ		FW04HBN	82679	WASHER, FLAT	EA	1
25	32	PADZZ		LWE04MRN	82679	WASHER, LOCK	EA	1
25	33	XBDZZ		BX228	82679	COVER, SHIELD RADIO FREQUENCY	EA	1
25	34	XBFZZ		SCBP0440BN5	82679	SCREW, MACH	EA	1
25	35	XBDZZ		FW04HBN	82679	WASHER, FLAT	EA	5
25	36	PADZZ		LWE004RN	82679	WASHER, LOCK	EA	4
25	38	PADZZ		NTH0440BN4	82679	NUT KEY	EA	1
25	39	PADZZ		FW04HBN	82679	FLAT WASHER	EA	1
25	40	XDHZZ		PC322	82679	PRINTED WIRING BOARD	EA	1
25	41	XBDZZ		MS6004	82679	STIFFENER, PC BOARD	EA	1
25	42	XBDZZ		SCBP0440BN4	82679	SCREW, MACH	EA	1
25	43	XBDZZ		SCBP0440BN5	82679	SCREW, MACHINE	EA	1
25	44	XBDZZ	FW04LBN	82679	WASHER, FLAT	EA	1	
						GROUP 03030114 CIRCUIT CARD, STEP GENERATOR C Z113		
26		PAHDD	5820-01-022-9715	A4506	82697	CIRCUIT CD, STEP GENERATOR C Z113	EA	1
26	1	PADZZ	5961-00-401-0507	CM111E270J5S	81349	CAPACITOR, FIXED, MICA DIEI	EA	3
26	2	PADZZ		2N5179	81349	TRANSISTOR	EA	13
26	3	PADZZ		CM111F910J5S	81349	CAPACITOR, FIXED, MICA DIEI	EA	13
26	4	PADZZ		CM111C180J5S	81349	CAPACITOR, FIXED, MICA DIEI	EA	1
26	5	PADZZ		0861-000XSR00101	18796	CAPACITOR, FIXED, CERAMIC DIEI	EA	54
26	6	PADZZ		CN111F131J5S	81349	CAPACITOR, FIXED, MICA DIEI	EA	1
26	7	PADZZ		0831-000Z5V00102	18796	CAPACITOR, FIXED, CERAMIC DIEI	EA	1
26	8	PADZZ		CM111E101FSS	81349	CAPACITOR, FIXED, MICA DIEI	EA	1
26	9	PADZZ		CN111E360J5S	81349	CAPACITOR, FIXED, MICA DIEI	EA	5
26	10	PADZZ		538-002-908	18796	CAPACITOR, VARIABLE, CERAMIC	EA	9
26	11	PADZZ		C111E7T50J5S	81349	CAPACITOR, FIXED, MICA DIEI	EA	2
26	12	PADZZ		CM111C100J5S	81349	CAPACITOR, FIXED, MICA DIEI	EA	5
26	13	PADZZ		C1111F111JSS	81349	CAPACITOR, FIXED, MICA DIEI	EA	2
26	14	PADZZ		CN111E8200FS	81349	CAPACITOR, FIXED, MICA DIEI	EA	2
26	15	PADZZ	0831-000ZSV00102	18796	CAPACITOR, FIXED, CERAMIC DIEI	EA	40	
26	16	PADZZ	C111C050D5S	81349	CAPACITOR, FIXED, MICA DIEI	EA	7	
26	17	PADZZ	5961-00-062-3133	2N3646	81349	TRANSISTOR	EA	7
26	18	PADZZ	5961-00-022-5664	1N914	81349	SEMICONDUCTOR DEVICE, DIODE	EA	2
26	19	PADZZ		1N627	81349	SEMICONDUCTOR DEVICE, DIODE	EA	2
26	20	PADZZ		CM1F181G5S	81349	CAPACITOR, FIXED, MICA DIEI	EA	1

SECTION II REPAIR PARTS LIST

(1) ILLUSTRATION		(2)	(3)	(4)	(5)	(6) DESCRIPTION	(7)	(8)
(a) FIG NO.	(b) ITEM NO.	SMR CODE	NATIONAL STOCK NUMBER	PART NUMBER	FSCM	USABLE ON CODE	U/M	QTY INC IN UNIT
26	21	PADZZ		MSP051030	13327	SEMICONDUCTOR DEVICE, DIODE	EA	2
26	22	PADZZ		CM110F621D5S	81349	CAPACITOR, FIXED, MICA DIEL	EA	
26	23	PADZZ	5910-00-905-6425	538-002-110D	18796	CAPACITOR, VARIABLE, CERAMIC	EA	
26	24	XBDZZ		RG188U	80058	CABLE, RADIO FREQUENCY	EA	1
26	25	PADZZ	5910-00-946-2288	538-002-92A	18796	CAPACITOR, VARIABLE, CERAMIC	EA	3
26	26	XDHZZ		PC324	82697	PRINTING WIRING BOARD	EA	1
26	27	XBDZZ		MS6004	82679	STIFFENER, PC BOARD	EA	1
26	28	XBDZZ	5310-00-171-8727	NTH0440BN6	82619	NUT, PLAIN, HEXAGON	EA	1
26	29	XBDZZ		SCBP0440BNS	87619	SCREW, MACHINE	EA	1
26	30	XBDZZ		FW04LBN	82619	WASHER, FLAT	EA	1
26	31	PADZZ		LWE04MRN	82679	WASHER, LOCK	EA	1
26	32	PADZZ	5905-00-133-0440	RC07GF560J	81349	RESISTOR, FIXED, COMPOSITION	EA	3
26	33	PADZZ	5905-00-109-8358	RC07GF822J	81349	RESISTOR, FIXED, COMPOSITION	EA	17
26	34	PADZZ	5905-00-110-7620	RC07GF102J	81349	RESISTOR, FIXED, COMPOSITION	EA	15
26	35	PADZZ	5915-01-008-8207	CL412-36	82619	COIL, RADIO FREQUENCY, FIXED	EA	3
26	36	PADZZ	5905-00-121-9919	RC0TGF106J	81349	RESISTOR, FIXED, COMPOSITION	EA	1
26	37	PADZZ	5962-00-115-7953	RC07GF180J	81349	RESISTOR, FIXED, COMPOSITION	EA	7
26	38	PADZZ	5905-00-135-3973	RC07GF221J	81349	RESISTOR, FIXED, COMPOSITION	EA	9
26	39	PADZZ	5915-01-008-8211	CL412-41	82679	RESISTOR, FIXED, COMPOSITION	EA	1
26	40	PADZZ	5905-00-119-3503	RC07GF271J	81349	RESISTOR, FIXED, COMPOSITION	EA	11
26	41	PADZZ		WEE82UH	83125	COIL, RADIO FREQUENCY, FIXED	EA	19
26	42	PADZZ	5905-00-105-7764	RC07GF222J	81349	RESISTOR, FIXED, COMPOSITION	EA	
26	43	PADZZ	5905-00-135-3975	RC07GF680J	81349	RESISTOR, FIXED, COMPOSITION	EA	
26	44	PADZZ	5915-01-008-8208	CL412-31	82677	COIL, RADIO FREQUENCY, FIXED	EA	2
26	45	PADZZ	5905-00-104-8368	RC07GF470J	81349	RESISTOR, FIXED, COMPOSITION	EA	16
26	46	PADZZ	5950-01-009-8787	1215-10	82679	TRANSFORMER, RADIO FREQ, FIXED	EA	3
26	47	PADZZ	5905-00-116-8569	RC07GF821J	81349	RESISTOR, FIXED, COMPOSITION	EA	9
26	48	PADZZ	5905-00-141-1183	RC07GF101J	81349	RESISTOR, FIXED, COMPOSITION	EA	6
26	49	PADZZ	5960-01-011-7529	TT287-12	82679	TRANSFORMER, RADIO FREQ, ADJ	EA	6
26	50	PADZZ		CI136-6	82679	CORE	EA	14
26	51	PADZZ	5950-01-006-8302	TT287-9	82619	TRANSFORMER, RADIO FREQ, ADJ	EA	2
26	52	PADZZ	5905-00-141-0742	RC07GF181J	81349	RESISTOR, FIXED, COMPOSITION	EA	7
26	53	PADZZ	5905-00-135-3971	RC07GF150J	81349	RESISTOR, FIXED, COMPOSITION	EA	2
26	54	PADZZ	5905-00-114-0710	RC07GF331J	81349	RESISTOR, FIXED, COMPOSITION	EA	7
26	55	PADZZ	5905-00-131-1255	RC07GF122J	81349	RESISTOR, FIXED, COMPOSITION	EA	6
26	56	PADZZ	5950-00-344-1863	WEE120UH	83125	COIL, RADIO FREQUENCY, FIXED	EA	11
26	57	PADZZ	5905-00-119-8812	RC07GF121J	81349	RESISTOR, FIXED, COMPOSITION	EA	3
26	58	PADZZ	5905-00-106-3668	RC07GF220J	81349	RESISTOR, FIXED, COMPOSITION	EA	2
26	59	PADZZ	5950-01-006-3803	T287-10	82679	TRANSFORMER, RADIO FREQ, ADJ	EA	4
26	60	PADZZ	5905-00-141-0717	RC07GF473J	81349	RESISTOR, FIXED, COMPOSITION	EA	4

SECTION II REPAIR PARTS LIST

(1) ILLUSTRATION		(2)	(3)	(4)	(5)	(6) DESCRIPTION	(7)	(8)
(a) FIG NO.	(b) ITEM NO.	SMR CODE	NATIONAL STOCK NUMBER	PART NUMBER	FSCM	USABLE ON CODE	U/M	QTY INC IN UNIT
26	61	PADZZ	5905-00-113-4860	RC07GF270J	81349	RESISTOR, FIXED, COMPOSITION	EA	2
26	62	PADZZ	5905-00-106-3666	RC07GF103J	81349	RESISTOR, FIXED, COMPOSITION	EA	2
26	63	PADZZ	5910-01-006-8307	TT287-21	82679	TRANSFORMER, RADIO FREQ, ADJ	EA	2
26	64	PADZZ		62P100	80740	RESISTOR, VARIABLE, COMPOSITION	EA	1
26	65	PADZZ	5950-01-006-8305	TT287-19	82679	TRANSFORMER, RADIO FREQ, ADJ	EA	1
26	66	PADZZ		62P500	80740	RESISTOR, VARIABLE, COMPOSITION	EA	1
26	67	PADZZ	5955-01-035-5235	CR109-124	82679	CRYSTAL UNIT, QUARTZ	EA	1
26	68	PADZZ		WEE12UH	83125	COIL, RADIO FREQUENCY, FIXED	EA	1
26	69	PADZZ		CL412-40	82679	COIL, RADIO FREQUENCY, FIXED	EA	1
26	70	PADZZ	5905-00-111-4858	RC20GF471J	81349	RESISTOR, FIXED, COMPOSITION	EA	3
26	71	PADZZ	5905-00-106-1356	RC07GF152J	81349	RESISTOR, FIXED, COMPOSITION	EA	2
26	72	PADZZ	5915-01-008-8210	CL412-39	82679	COIL, RADIO FREQUENCY, FIXED	EA	1
26	73	PADZZ	5950-01-017-0208	T1215-8	82679	TRANSFORMER, RADIO FREQ, FIXED	EA	3
26	74	PADZZ	5950-01-008-2488	T2215-11	82679	TRANSFORMER, RADIO FREQ, FIXED	EA	1
26	75	PADZZ	5905-00-141-0591	RC20GF103J	81349	RESISTOR, FIXED, COMPOSITION	EA	1
26	76	PADZZ	5915-01-008-8209	CL412-38	82679	COIL, RADIO FREQUENCY, FIXED	EA	1
26	77	PADZZ	5905-00-107-0656	RC07GF100J	81349	RESISTOR, FIXED, COMPOSITION	EA	1
26	78	PADZZ	5905-00-126-6683	RC07GF332J	81349	RESISTOR, FIXED, COMPOSITION	EA	1
26	79	PADZZ	5905-00-116-8555	RC07GF153J	81349	RESISTOR, FIXED, COMPOSITION	EA	1
26	80	PADZZ	5950-01-015-4990	TZ215-6	82679	TRANSFORMER, RADIO FREQ, FIXED	EA	3
26	81	PADZZ	599-01-034-8296	HD109	82679	HEATSINK	EA	1
						GROUP 03030115 CIRCUIT CARD, TRANSLATOR ASSEMBLY Z112		
27		PAHDD	5805-01-010-4985	A4505	82679	CIRCUIT CD, TRANSLATOR Z112	EA	1
27	1	PADZZ		CM111C180J5S	81349	CAPACITOR, FIXED, MICA DIEL	EA	3
27	2	XBDZZ	5940-00-159-0245	X14578	71279	TERMINAL, STUD	EA	9
27	3	PADZZ	5961-00-062-3133	2N3646	81349	TRANSISTOR	EA	11
27	4	PADZZ		0831-000Z5V00102	18796	CAPACITOR, FIXED, CERAMIC DIEL	EA	29
27	5	PADZZ		CM111F111J5S	81349	CAPACITOR, FIXED, MICA DIEL	EA	10
27	6	PADZZ		CM111C0500D5S	81349	CAPACITOR, FIXED, MICA DIEL	EA	4
27	7	PADZZ	5910-00-939-7396	5815-200Y5U0204Z	18796	CAPACITOR, FIXED, CERAMIC DIEL	EA	2
27	8	PADZZ		NLW100-25	56289	CAPACITOR, FIXED, ELECTROLYTIC	EA	1
27	9	PADZZ	5910-00-945-7959	0801000X5V00222P	18796	CAPACITOR, FIXED, CERAMIC DIEL	EA	1
27	10	PADZZ		CC100-40	82679	CAPACITOR, FIXED, CERAMIC, DIEL	EA	3
27	11	PADZZ		CM111F101G5S	81349	CAPACITOR, FIXED, MICA, DIEL	EA	2
27	12	PADZZ		CM111F511G5S	81349	CAPACITOR, FIXED, MICA DIEL	EA	11
27	12A	PADZZ		CM111F561F5S	81349	CAPACITOR, FIXED, MICA DIEL	EA	1
27	13	PADZZ	5910-00-775-4045	8131M103X5V0104Z	18795	CAPACITOR, FIXED, CERAMIC DIEL	EA	4
27	14	PADZZ		CM111F391F5S	81349	CAPACITOR, FIXED, MICA DIEL	EA	21
27	15	PADZZ		CM111F361G5S	81349	CAPACITOR, FIXED, MICA DIEL	EA	2
27	16	PADZZ		CM111F131G5S	81349	CAPACITOR, FIXED, MICA DIEL	EA	1

SECTION II REPAIR PARTS LIST

(1) ILLUSTRATION		(2)	(3)	(4)	(5)	(6) DESCRIPTION	(7)	(8)
(a) FIG NO.	(b) ITEM NO.	SMR CODE	NATIONAL STOCK NUMBER	PART NUMBER	FSCM	USABLE ON CODE	U/M	QTY INC IN UNIT
27	17	PADZZ		0861-000X5R00101	18796	CAPACITOR, FIXED, CERAMIC DIELECTRIC	EA	12
27	18	PADZZ	5961-00-401-0507	2N5179	81349	TRANSISTOR	EA	4
27	19	PADZZ	5950-01-006-9910	TT285-10	82679	TRANSFORMER, RADIO FREQ, ADJ	EA	3
27	20	PADZZ		CI136-6	82679	CORE	EA	3
27	21	PADZZ	5905-00-141-0717	RC07GF473J	81349	RESISTOR, FIXED, COMPOSITION	EA	6
27	22	PADZZ	5905-00-110-0388	RC07GF104J	81349	RESISTOR, FIXED, COMPOSITION	EA	6
27	23	PADZZ	5905-00-104-8368	RC07GF470J	81349	RESISTOR, FIXED, COMPOSITION	EA	13
27	24	PADZZ	5905-00-135-6045	RC07GF330J	81349	RESISTOR, FIXED, COMPOSITION	EA	3
27	25	PADZZ	5905-00-110-7620	RC07GF102J	81349	RESISTOR, FIXED, COMPOSITION	EA	10
27	26	PADZZ	5905-00-141-1183	RC07GF101J	81349	RESISTOR, FIXED, COMPOSITION	EA	6
27	27	PADZZ		MSP051031	13327	SEMICONDUCTOR DEVICE, DIODE	EA	2
27	28	PADZZ		WEE8-2UH	83125	COIL, RADIO FREQUENCY, FIXED	EA	5
27	29	PADZZ	5950-01-080-8629	TT285-2	82679	TRANSFORMER, RADIO FREQ, ADJ	EA	10
27	30	PADZZ	5905-00-105-7765	RC07GF224J	81349	RESISTOR, FIXED, COMPOSITION	EA	1
27	31	PADZZ	5905-00-119-8812	RC07GF121J	81349	RESISTOR, FIXED, COMPOSITION	EA	3
27	32	PADZZ	5905-00-485-4545	RC07GF334J	81349	RESISTOR, FIXED, COMPOSITION	EA	1
27	33	PADZZ	5905-00-106-3666	RC07GF103J	81349	RESISTOR, FIXED, COMPOSITION	EA	3
27	34	PADZZ		RC07GF824J	81349	RESISTOR, FIXED, COMPOSITION	EA	1
27	35	PADZZ		62P2000	80740	RESISTOR, VARIABLE, COMPOSITION	EA	1
27	36	PADZZ	5905-00-114-0711	RC07GF472J	81349	RESISTOR, FIXED, COMPOSITION	EA	2
27	37	PADZZ		WEE22UH	83125	COIL, RADIO FREQUENCY, FIXED	EA	3
27	38	PADZZ	5905-00-106-3668	RC07GF220J	81349	RESISTOR, FIXED, COMPOSITION	EA	2
27	39	PADZZ	5905-00-119-3504	RC07GF273J	81349	RESISTOR, FIXED, COMPOSITION	EA	2
27	40	PADZZ	5905-00-120-9154	RC07GF471J	81349	RESISTOR, FIXED, COMPOSITION	EA	4
27	41	PADZZ	5950-00-344-1863	WEE120UH	83125	COIL, RADIO FREQUENCY, FIXED	EA	9
27	42	PADZZ	5905-00-116-8556	RC07GF223J	81349	RESISTOR, FIXED, COMPOSITION	EA	4
27	43	PADZZ	5961-00-022-5664	1N914	81349	SEMICONDUCTOR DEVICE, DIODE	EA	3
21	44	PADZZ	5905-00-119-8768	RC07GF821J	81349	RESISTOR, FIXED, COMPOSITION	EA	2
27	45	PADZZ	5905-00-106-1357	RC07GF563J	81349	RESISTOR, FIXED, COMPOSITION	EA	2
27	46	PADZZ	5905-00-119-3505	RC07GF683J	81349	RESISTOR, FIXED, COMPOSITION	EA	2
27	47	PADZZ		62P100	80740	RESISTOR, VARIABLE, COMPOSITION	EA	1
27	48	PADZZ	5905-00-119-8811	RC07GF151J	81349	RESISTOR, FIXED, COMPOSITION	EA	4
27	49	PADZZ	5905-00-126-6688	RC07GF8R2J	81349	RESISTOR, FIXED, COMPOSITION	EA	1
27	50	PADZZ	5905-00-126-6683	RC07GF332J	81349	RESISTOR, FIXED, COMPOSITION	EA	1
27	51	PADZZ	5905-00-109-8358	RC07GF822J	81349	RESISTOR, FIXED, COMPOSITION	EA	2
27	52	PADZZ	5950-01-012-8032	TZ220	82679	TRANSFORMER, RADIO FREQ, FIXED	EA	1
27	53	XBDZZ		CF105-06	95566	CORE, TOROID	EA	1
27	54	XADZZ		NT137-0440	82679	NUT, PLAIN, HEXAGON	EA	1
27	55	XBDZZ		WA109-52	82679	WASHER, FLAT	EA	1
27	56	XBDZZ		SC143-044088W	82679	SCREW, MACHINE, NYLON	EA	1

SECTION II REPAIR PARTS LIST

(1) ILLUSTRATION		(2)	(3)	(4)	(5)	(6) DESCRIPTION	(7)	(8)
(a) FIG NO.	(b) ITEM NO.	SMR CODE	NATIONAL STOCK NUMBER	PART NUMBER	FSCM	USABLE ON CODE	U/M	QTY INC IN UNIT
27	57	PADZZ	5905-00-135-3973	RC07GF221J	81349	RESISTOR, FIXED, COMPOSITION	EA	5
27	58	PADZZ	5915-01-010-8412	CL412-24	82679	COIL, RADIO FREQUENCY, FIXED	EA	1
27	59	PADZZ	5905-00-246-9396	RC20GF226J	81349	RESISTOR, FIXED, COMPOSITION	EA	1
27	60	PADZZ	5950-00-887-1794	AMU13WA	90095	TRANSFORMER, PULSE	EA	1
27	61	PADZZ	5961-00-168-2887	1N4864	81349	SEMICONDUCTOR DEVICE, DIODE	EA	2
27	62	PADZZ	5015-01-016-2987	CL412-25	82679	COIL, RADIO FREQUENCY, FIXED	EA	1
27	63	PADZZ	5905-00-246-9396	RC20GF226J	81349	RESISTOR, FIXED, COMPOSITION	EA	1
27	64	PADZZ	5950-01-008-8630	TT285-4	82679	TRANSFORMER, RADIO FREQ, ADJ	EA	1
27	65	PADZZ		CI136-6	82679	CORE	EA	1
27	66	PADZZ		62P500	80740	RESISTOR, VARIABLE, COMPOSITION	EA	2
27	67	PADZZ		WEE1UH	83125	COIL, RADIO FREQUENCY, FIXED	EA	6
27	68	PADZZ	5905-00-105-7768	RC07GF561J	81349	RESISTOR, FIXED, COMPOSITION	EA	1
27	69	PADZZ		RC07GF820J	81349	RESISTOR, FIXED, COMPOSITION	EA	1
27	70	PADZZ	5905-00-113-4861	RC07GF390J	81349	RESISTOR, FIXED, COMPOSITION	EA	2
27	71	PADZZ	5950-01-406-8308	TZ215-1	82679	TRANSFORMER, RADIO FREQ, FIXED	EA	3
27	72	PADZZ	5905-00-935-8545	RC20GF183J	81349	RESISTOR, FIXED, COMPOSITION	EA	3
27	73	PADZZ		CM111E470G5S	81349	CAPACITOR, FIXED, MICA DIELECTRIC	EA	3
27	74	PADZZ	5910-00-947-8247	538-002-89A	18796	CAPACITOR, VARIABLE CERAMIC	EA	3
27	75	PADZZ	5905-00-114-0710	RC07GF331J	81349	RESISTOR, FIXED, COMPOSITION	EA	1
27	76	PADZZ	5905-00-110-7622	RC07GF682J	81349	RESISTOR, FIXED, COMPOSITION	EA	1
27	77	PADZZ		CM111E510G5S	81349	CAPACITOR, FIXED, MICA DIELECTRIC	EA	4
27	78	PADZZ	5910-00-905-6425	538-002-110D	18796	CAPACITOR, VARIABLE, CERAMIC	EA	1
27	79	PADZZ	5950-01-006-8322	CL412-23	82679	COIL, RADIO FREQUENCY, FIXED	EA	1
27	80	XBDZZ		PX370-8-7	82679	INSULATION, SLEEVING, ELECTRICAL	EA	1
27	81	PADZZ		CM11C220JSS	81349	CAPACITOR, FIXED, MICA OIL	EA	2
27	82	PADZZ	5961-00-110-7491	5082-2900	28480	SEMICONDUCTOR DEVICE, DIODE	EA	1
27	83	PAFZZ		WEE39UH	83125	COIL, RADIO FREQUENCY, FIXED	EA	1
27	84	PADZZ		CM111E680F5S	81349	CAPACITOR, FIXED, MICA DIELECTRIC	EA	1
27	85	PADZZ		WEE82UH	83125	COIL, RADIO FREQUENCY, FIXED	EA	1
27	86	PADZZ		CM111E330G5S	81349	CAPACITOR, FIXED, MICA DIELECTRIC	EA	1
27	87	PADZZ		CM111F751G5S	81349	CAPACITOR, FIXED, MICA DIELECTRIC	EA	1
27	88	PADZZ		CM111E750J5S	81349	CAPACITOR, FIXED, MICA DIELECTRIC	EA	1
27	89	PADZZ	5905-00-141-0744	RC07GF562J	81349	RESISTOR, FIXED, COMPOSITION	EA	1
27	90	XBDZZ		BX222	82679	SHIELD, RADIO FREQ GENERATOR	EA	1
27	91	XBDZZ		FW04HBN	82679	WASHER, FLAT	EA	1
27	92	PADZZ		LWE04MRN	82679	WASHER, LOCK	EA	1
27	93	XBDZZ	5310-00-171-8727	NTH0440BN6	82679	NUT, PLAIN, HEXAGON	EA	1
27	94	XBDZZ		8X223	82679	SHIELD, RADIO FREQ GENERATOR	EA	1
27	95	XBDZZ		FW04HBN	82679	WASHER, FLAT	EA	1
27	96	PADZZ		LWE04MRN	82679	WASHER, LOCK	EA	1

SECTION II REPAIR PARTS LIST

(1) ILLUSTRATION		(2)	(3)	(4)	(5)	(6) DESCRIPTION	(7)	(8)
(a) FIG NO.	(b) ITEM NO.	SMR CODE	NATIONAL STOCK NUMBER	PART NUMBER	FSCM	USABLE ON CODE	U/M	QTY INC IN UNIT
27	97	XBDZZ	5310-00-171-8727	NTH0440BN6	82679	NUT, PLAIN, HEXAGON	EA	1
27	98	XBDZZ		BX224	82679	SHIELD, RADIO FREQ GENERATOR	EA	1
21	99	XBDZZ		FW04HBN	82679	WASHER, FLAT	EA	1
27	100	PADZZ		LWE04MRN	82679	WASHER, LOCK	EA	1
27	101	XBDZZ	5310-00-111-8727	NTH0440BN6	82679	NUT, PLAIN, HEXAGON	EA	1
27	102	XBDZZ		MS5395	82679	STIFFENER, PC BOARD	EA	1
27	103	XBDZZ	5310-00-171-8727	NTH04408N6	82679	NUT, PLAIN, HEXAGON	EA	1
21	104	XBDZZ		SCBP0440BN5	82679	SCREW, MACHINE	EA	1
27	105	XBDZZ		FW04LBN	82679	WASHER, FLAT	EA	1
27	106	PADZZ		LWE04MRN	82679	WASHER, LOCK	EA	1
27	107	XBDZZ		RG188U	80058	CABLE, RADIO FREQUENCY	EA	1
27	108	XDHZZ		PC323	82679	PRINTED WIRING BOARD	EA	1
						GROUP 0303011501 CIRCUIT CARD, 120MHZ GENERATOR		
28		XAHZZ		A4600	82679	CIRCUIT CD, 120MHZ GENERATOR	EA	1
28	1	PADZZ	P901-00-141-0742	RC07GF181J	81349	RESISTOR, FIXED, COMPOSITION	EA	2
28	2	PADZZ	5961-00-062-3133	2N3646	81349	TRANSISTOR	EA	2
28	3	PADZZ	5950-01-017-8253	TZ215-4	82679	TRANSFORMER, RADIO FREQ, FIXED	EA	2
28	4	PADZZ	5905-00-246-9396	RC20GF226J	81349	RESISTOR, FIXED, COMPOSITION	EA	1
28	5	PADZZ	5905-00-246-9396	RC20GF226J	81349	RESISTOR, FIXED, COMPOSITION	EA	1
28	6	PADZZ	5910-00-947-8247	538-002-89A	18796	CAPACITOR, VARIABLE, CERAMIC	EA	3
28	7	PADZZ		0861-000X5R00101	18796	CAPACITOR, FIXED, CERAMIC DIEL	EA	11
28	8	PADZZ	5905-00-107-0656	RC07GF100J	81349	RESISTOR, FIXED, COMPOSITION	EA	
28	9	PADZZ	5905-00-110-7620	RC07GF102J	81349	RESISTOR, FIXED, COMPOSITION	EA	3
28	10	PADZZ	5305-00-109-8358	RC07GF822J	81349	RESISTOR, FIXED, COMPOSITION	EA	2
28	11	PADZZ	5905-00-135-6045	RC07GF330J	81349	RESISTOR, FIXED, COMPOSITION	EA	2
28	12	PADZZ	5905-00-104-8368	RC07GE470J	81349	RESISTOR, FIXED, COMPOSITION	EA	4
28	13	PADZZ	5905-00-141-0717	RC07GF473J	81349	RESISTOR, FIXED, COMPOSITION	EA	1
28	14	PADZZ	5961-00-401-0507	2N5179	81349	RESISTOR, FIXED, COMPOSITION	EA	1
28	15	PADZZ	5905-00-110-0388	RC07GF104J	81349	TRANSISTOR	EA	1
28	16	PADZZ	5950-01-017-8309	TZ215-3	83679	TRANSFORMER, RADIO FREQ, FIXED	EA	1
28	17	PADZZ	5905-00-246-9396	RC20GF226J	81349	RESISTOR, FIXED, COMPOSITION	EA	1
28	18	PADZZ	5950-01-017-1792	TZ215-2	82679	TRANSFORMER, RADIO FREQ, FIXED	EA	1
28	19	PADZZ	5905-00-246-9396	RC20GF226J	81349	RESISTOR, FIXED, COMPOSITION	EA	1
28	20	PADZZ		MSP051031	13327	SEMICONDUCTOR DEVICE, DIODE	EA	2
28	21	PADZZ		62P500	80740	RESISTOR, FIXED, COMPOSITION	EA	1
28	22	PADZZ		CM111E470G5S	81349	CAPACITOR, FIXED, MICA DIEL	EA	3
28	23	PADZZ	5910-00-946-2288	538-002-92A	18796	CAPACITOR, VARIABLE, CERAMIC	EA	1
28	24	PADZZ	5950-00-344-1863	WEE120UH	83125	COIL, RADIO FREQUENCY, FIXED	EA	2
28	25	PADZZ		0831-000Z5V00102	18796	CAPACITOR, FIXED, CERAMIC DIEL	EA	2
28	26	PADZZ		CM111F111J5S	81349	CAPACITOR, FIXED, MICA DIEL	EA	2

SECTION II REPAIR PARTS LIST

(1) ILLUSTRATION		(2)	(3)	(4)	(5)	(6) DESCRIPTION	(7)	(8)
(a) FIG NO.	(b) ITEM NO.	SMR CODE	NATIONAL STOCK NUMBER	PART NUMBER	FSCM	USABLE ON CODE	U/M	QTY INC IN UNIT
28	27	PADZZ	5905-00-119-8812	RC07BF121J	81349	RESISTOR, FIXED, COMPOSITION	EA	1
28	28	PADZZ		WEE22UH	83125	COIL , RADIO FREQUENCY, FIXED	EA	1
28	29	PADZZ		WEE11UH	83102	COIL , RADIO FREQUENCY, FIXED	EA	3
28	30	PADZZ	5905-00-114-0710	RC07GF331J	81349	RESISTOR, FIXED, COMPOSITION	EA	2
28	31	XDHZZ		PC377	82679	PRINTED WIRING BOARD	EA	1
						GROUP 03030116 EXCITER, MULTIMODE SUBASSEMBLY A1A2		
29		XDHFF		BMA105	82679	EXCITER, MULTIMODE SUBASSEMBLY A1A2	EA	1
29	1	PAFZZ	5910-00-905-60861	TYPE315-10	09134	CAPACITOR, FIXED, METALLIC DIEL	EA	1
29	2	PADZZ	5950-00-344-1863	WEE120UH	33125	COIL, RADIO FREQUENCY, FIXED	EA	18
29	3	PADZZ	5910-00-591-2260	10811000X5V00103	18796	CAPACITOR, FIXED, CERAMIC DIEL	EA	11
29	4	PAFZZ	5915-01-016-8262	FX287	82679	FILTER, LOW PASS	EA	1
29	5	PADZZ	5910-00-775-4045	8131M1003X5V01041	18796	CAPACITOR, FIXED, CERAMIC DIEL	EA	15
29	6	PADZZ		CC100-41	82679	CAPACITOR, FIXED, CERAMIC DIEL	EA	1
29	7	PADZZ		WEE22UH	83125	COIL, RADIO FREQUENCY, FIXED	EA	1
29	8	PADZZ		0831-000ZSV00121	18796	CAPACITOR, FIXED, CERAMIC DIEL	EA	17
29	9	PADZZ	5910-00-939-7396	5815-200Y5U0204Z	18796	CAPACITOR, FIXED, CERAMIC DIEL	EA	1
29	10	PADZZ		WEO.82UH	83125	COIL, RADIO FREQUENCY, FIXED	EA	1
29	11	PADZZ		RC07GF820J	81349	RESISTOR, FIXED, COMPOSITION	EA	1
29	12	PADZZ		RC07GF680J	81349	RESISTOR, FIXED, COMPOSITION	EA	1
29	13	PADZZ	5935-00-481-4486	JJ319A15DFF	82679	CONNECTOR, RECEPTACLE, ELEC	EA	15
29	14	PADZZ		1N627	81349	SEMICONDUCTOR DEVICE, DIODE	EA	2
29	15	PADZZ		RC7GF470J	81349	RESISTOR, FIXED, COMPOSITION	EA	1
29	16	PADZZ		0831-000Z5V00102	18796	CAPACITOR, FIXED, CERAMIC DIEL	EA	2
29	17	PAFZZ	5961-00-148-8976	1N34	81349	SEMICONDUCTOR DEVICE, DIODE	EA	1
29	18	PADZZ		0861-00X5R00101	18796	CAPACITOR, FIXED, CERAMIC DIEL	EA	1
29	19	XBFZZ		MS55112	82679	ANGLE, STIFFENER	EA	2
29	20	XBFZZ		MS6009	82679	BRACKET, CONNECTOR, PC BOARD	EA	12
29	21	XBFZZ		35-1825-3	18915	RETAINER, PC BOARD	EA	2
29	22	PAFZZ		84200025U2X103P	18796	CAPACITOR, FIXED, CERAMIC DIEL	EA	3
29	22A	PADZZ	5905-00-106-1357	RC07GF563J	81349	RESISTOR, FIXED, COMPOSITION	EA	1
29	23	XDHFF		BMA1D3	82679	FRAME ASSEMBLY	EA	1
29	24	XBFZZ		M56015	82679	FRAME, REAR	EA	1
29	25	PAFZZ	5905-00-136-7104	RC07GF304J	81349	RESISTOR, FIXED, COMPOSITION	EA	1
29	26	PAFZZ		2B	17870	RESISTOR, FIXED, WIREWOUND	EA	3
29	27	XDHFF		14593	82679	CIRCUIT CD, RESISTOR ASSY	EA	1
29	28	PAFZZ		RV108-2	82679	RESISTOR, DUAL VARIABLE, COMP	EA	1
29	29	PAFZZ		TS153-5	82679	LIGHT, INDICATOR, WHITE	EA	1
29	30	PAFZZ		TS153-1	82679	LIGHT, INDICATOR, RED	EA	1
29	31	XDHFF		BMA101	82679	BRACKET ASSEMBLY, SWITCH	EA	1
29	32	XBFZZ		BMA100	82679	PANE ASSEMBLY, FRONT	EA	1

SECTION II REPAIR PARTS LIST

(1) ILLUSTRATION		(2)	(3)	(4)	(5)	(6)	(7)	(8)
(a) FIG NO.	(b) ITEM NO.	SMR CODE	NATIONAL STOCK NUMBER	PART NUMBER	FSCM	DESCRIPTION USABLE ON CODE	U/M	QTY INC IN UNIT
29	33	PAFZZ		ST22N	82679	SWITCH, TOGGLE DPDT	EA	2
29	34	PAFZZ	6240-00-155-7836	327	85599	LAMP, INCANDESCENT	EA	2
29	35	PAFZZ		FU102-9	82679	FUSEHOLDER	EA	4
29	36	PAFZZ		FU102-10	82679	FUSE, CARTRIDGE	EA	8
29	37	PAFZZ		JT97348	01121	RESISTOR, VARIABLE, COMPOSITION	EA	2
29	38	PAFZZ		MR191-9	82679	METER	EA	1
29	39	XBFZZ		LD2209MS6016	82679	FRAME, FRONT END	EA	1
29	40	PADZZ		0831-000Z5V00102	18796	CAPACITOR, FIXED, CERAMIC DIEL	EA	14
29	41	PAFZZ		AS132	82679	SWITCH ASSEMBLY, METER	EA	1
29	42	PAFZZ	5930-01 38262	265434F2	76854	SWITCH, ROTARY	EA	1
29	43	PAFZZ		RV4NAYS501A	82679	RESISTOR, VARIABLE	EA	1
29	44	PAFZZ	5935-00-192-4729	JJ033	82389	JACK, TELEPHONE	EA	1
29	45	PAFZZ		JJ034	82389	JACK, TELEPHONE	EA	1
29	46	PAFZZ	5905-00-752-3767	RV106UX8B103A	82679	RESISTOR, VARIABLE, COMPOSITION	EA	1
29	47	XDFFF		A4592	82679	CIRCUIT CD, RESISTOR ASSY	EA	1
29	48	PADZZ	5905-00-141-1183	RC07GF101J	81349	RESISTOR, FIXED, COMPOSITION	EA	1
29	49	PADZZ	5905-00-120-9154	RC07GF471J	81349	RESISTOR, FIXED, COMPOSITION	EA	26
29	50	PADZZ	5905-00-141-1183	RC07GF101J	81349	RESISTOR, FIXED, COMPOSITION	EA	1
29	51	PADZZ	5905-00-120-9154	RC07GF471J	81349	RESISTOR, FIXED, COMPOSITION	EA	26
29	52	PAFZZ		WEE39UH	83125	COIL, RADIO FREQUENCY, FIXED	EA	1
29	53	PAFZZ		CM111F102J1S	81349	CAPACITOR, FIXED, MICA DIEL	EA	1
29	54	PADZZ		CM111F131J5S	81349	CAPACITOR, FIXED, MICA DIEL	EA	1
29	55	PAFZZ		CM111F161J3S	81349	CAPACITOR, FIXED, MICA DIEL	EA	1
29	56	PAFZZ		CM111F151J5S	81349	CAPACITOR, FIXED, MICA DIEL	EA	1
29	57	PAFZZ		CM111F241J5S	81349	CAPACITOR, FIXED, MICA DIEL	EA	1
29	58	PAFZZ		WKJ06D48VDC	02288	RELAY, ARMATURE	EA	1
29	59	XBFZZ		CA1364	82679	WIRING HARNESS, BRANCHED	EA	1
29	60	PADZZ		0831-000Z5V00102	18796	CAPACITOR, FIXED, CERAMIC DIEL	EA	5
29	61	PAFZZ	5930-00-006-8260	265432F2X	76854	SWITCH, ROTARY	EA	1
29	62	PAFZZ	5930-01-012-7978	265431F5X	76854	SWITCH, ROTARY	EA	1
29	63	PAFZZ	5930-01-006-8261	265440F1X	76854	SWITCH, ROTARY	EA	3
29	64	PAFZZ	5930-01-006-8259	265439F2X	76854	SWITCH, ROTARY	EA	1
29	65	PADZZ	5905-00-110-7620	RC07GF102J	81349	RESISTOR, FIXED, COMPOSITION	EA	2
29	66	PAFZZ		AS129	82679	SWITCH ASSEMBLY, MODE	EA	1
29	67	PADZZ	5905-00-135-3973	RC07GF221J	81349	RESISTOR, FIXED, COMPOSITION	EA	1
29	68	PAFZZ	5930-01-011-1830	265443F3	76854	SWITCH, ROTARY	EA	1
29	69	PADZZ	5910-00-775-4045	8131M103X5V0104Z	18796	CAPACITOR, FIXED, CERAMIC DIEL	EA	1
29	70	XDFFF		A4751	82679	CIRCUIT CO, SWITCH FILTER	EA	1
29	71	PAFZZ	5950-00-744-9895	WEE68UH	83125	COIL, RADIO FREQUENCY, FIXED	EA	2
29	72	PAFZZ		CM111F271J5S	81349	CAPACITOR, FIXED, MICA DIEL	EA	1
29	73	PAFZZ		CM111F181J5S	81349	CAPACITOR, FIXED, MICA DIEL	EA	1

REPAIR PARTS LIST

SECTION II REPAIR PARTS LIST

(1) ILLUSTRATION		(2)	(3)	(4)	(5)	(6) DESCRIPTION	(7)	(8)
(a) FIG NO.	(b) ITEM NO.	SMR CODE	NATIONAL STOCK NUMBER	PART NUMBER	FSCM	USABLE ON CODE	U/M	QTY INC IN UNIT
29	74	XDFZZ		CA1377	82679	CABLE ASSEMBLY, SPCL PRP, ELEC	EA	1
29	75	PAFZZ		CB21QB102K	82679	CAPACITOR, FIXED, MICA DIEL	EA	11
29	76	XBFZZ		600AY6	75382	TERMINAL BOARD	EA	3
29	77	PADZZ	5950-00-671-5208	9350-10	74693	COIL, RADIO FREQUENCY, FIXED	EA	11
29	78	PAFZZ	5935-00-060-8611	6410-1	95712	CONNECTOR, PLUG, ELECTRICAL	EA	1
29	79	PAFZZ		2N1488	82679	TRANSISTOR	EA	3
29	80	XBFZZ		CA1394	82679	WIRING HARNESS, BRANCHED	EA	1
29	81	PADZZ	5905-00-120-9154	RC07GF471J	81349	RESISTOR, FIXED, COMPOSITION	EA	2
29	82	PAFZZ	5030-11-034-8121	112	76385	SWITCH, TOGGLE SPOT	EA	2
29	83	PAFZZ	5935-00-835-0510	UG625U	80058	CONNECTOR, RECEPTACLE RF	EA	6
29	84	PADZZ		WEEB-2UH	83125	COIL, RADIO FREQUENCY, FIXED	EA	1
29	85	PADZZ	5905-00-110-7620	RC07GF102J	81349	RESISTOR, FIXED, COMPOSITION	EA	1
29	86	PADZZ	5905-00-105-7764	RC07GF222J	81349	RESISTOR, FIXED, COMPOSITION	EA	1
29	87	PAFZZ	5935-00-636-5918	MS3102A1655P	96906	CONNECTOR, RECEPTACLE, ELEC	EA	1
29	88	PAHZZ		RV106UXBB102A	82679	RESISTOR, VARIABLE, COMPOSITION	EA	1
29	89	PADZZ	5905-00-141-0717	RC07GF473J	81349	RESISTOR, FIXED, COMPOSITION	EA	1
29	90	XDFZZ		BMA104	82679	PANEL ASSEMBLY, EAR	EA	1
29	91	PAFZZ		AS131	82679	SWITCH ASSEMBLY, SHIFT	EA	1
29	92	PADZZ	5905-00-141-0717	RC07GF473J	81349	RESISTOR, FIXED, COMPOSITION	EA	1
29	93	PAFZZ	5930-01-006-8263	265436F1	76854	SWITCH, ROTARY	EA	1
29	94	PADZZ	5905-00-110-7620	RC07GF102J	81349	RESISTOR, FIXED, COMPOSITION	EA	2
29	96	PADZZ	5905-00-105-7764	RC07GF222J	81349	RESISTOR, FIXED, COMPOSITION	EA	1
29	97	PAFZZ	5905-00-228-5506	RC07GF622J	81349	RESISTOR, FIXED, COMPOSITION	EA	1
29	98	PAFZZ	5030-01-012-7979	265435F1	76854	SWITCH, ROTARY	EA	1
29	99	PAFZZ	5905-00-171-1975	RC42GF151J	81349	RESISTOR, FIXED, COMPOSITION	EA	2
29	100	XDFFF		AS130	82679	SWITCH ASSEMBLY, LOOP	EA	1
29	101	PAFZZ	5905-00-114-5441	RC20GF563J	81349	RESISTOR, FIXED, COMPOSITION	EA	1
29	102	PAFZZ	5905-00-106-9351	RC20GF273J	81349	RESISTOR, FIXED, COMPOSITION	EA	1
29	103	PAFZZ	5905-00-111-4738	RC20GF152J	81349	RESISTOR, FIXED, COMPOSITION	EA	1
29	104	PADZZ	5905-00-141-1116	RC20GF562J	81349	RESISTOR, FIXED, COMPOSITION	EA	1
29	105	PAFZZ	5905-00-141-0600	RC20GF822J	81349	RESISTOR, FIXED, COMPOSITION	EA	1
29	106	PAFZZ	5999-01-035-5789	BMA173	82679	HEAT SINK ASSEMBLY	EA	1
29	107	PAFZZ	5905-00-752-3767	RV106UXBB103A	82679	RESISTOR, VARIABLE COMPOSITION	EA	1
29	108	XBFZZ		35-18B24-3	18915	RETAINER, PC BOARD	EA	2
29	109	XBFZZ	5945-00-905-3933	TF154-2C24V0C	02288	RELAY, ARMATURE	EA	1
29	110	PAFZZ	5935-00-135-0508	UG88U	88058	CONNECTOR PLUG. ELECTRICAL	EA	1
						GROUP 0303011601 POWER SUPPLY		
30		XDFFF		AX652	82679	POWER SUPPLY	EA	1
30	1	PAFZZ	5910-00-910-6104	385700025V00104Z	18796	CAPACITOR, FIXED, CERAMIC DIEL	EA	4
30	2	PAFZZ	5935-00-852-9150	77MIP8	02660	SOCKET, ELECTRON TUBE	EA	2

SECTION II REPAIR PARTS LIST

(1) ILLUSTRATION		(2)	(3)	(4)	(5)	(6) DESCRIPTION	(7)	(8)
(a) FIG NO.	(b) ITEM NO.	SMR CODE	NATIONAL STOCK NUMBER	PART NUMBER	FSCM	USABLE ON CODE	U/M	QTY INC IN UNIT
30	3	PAFZZ	5935-00-080-2944	6411-1	95712	CONNECTOR, RECEPTACLE, ELEC	EA	2
30	4	PADZZ	5950-00-344-1863	WEE120UH	83125	COIL, RADIO FREQUENCY, FIXED	EA	1
30	5	PAFZZ	5910-00-905-2610	TYPE315-47	09134	CAPACITOR, FIXED, COMPOSITION	EA	1
30	6	PADZZ	5905-00-111-4734	RC20GF470J	81349	RESISTOR, FIXED, COMPOSITION	EA	1
30	7	PAFZZ		SM14PNSSA	30194	CONNECTOR, RECEPTACLE, ELEC	EA	1
30	8	PAFZZ		SM14PNSS	30194	CONNECTOR, RECEPTACLE, ELEC	EA	1
30	9	PAFZZ	5910-00-102-8031	39D157G075FJ4	56289	CAPACITOR, FIXED, ELECTROLYTIC	EA	1
30	10	XBDZZ		JJ319-60PE	82679	CONNECTOR, RECEPTACLE, ELEC	EA	2
30	11	PAFZZ		5F150HM	12697	RESISTOR, FIXED, WIREWOUND	EA	1
30	12	XBFZZ		LD2202MS6010	82679	BRACKET, MOUNTING	EA	1
30	13	PAFDD	5820-01-016-8194	A0121	82679	OSCILLATOR, OVENIZED	EA	1
30	14	XBFFF		BMA151	82679	POWER SUPPLY ASSEMBLY	EA	1
30	15	PAFZZ	5920-01-016-8237	TF0352	82679	STEP-DOWN	EA	1
30	16	PAFZZ		1N2484A	81349	SEMICONDUCTOR DEVICE, DIODE	EA	1
30	17	PAFZZ	582-01-020-2205	1N2484	81349	SEMICONDUCTOR DEVICE, DIODE	EA	2
30	18	PAFZZ		X663F-105-200-20	92741	CAPACITOR, FIXED, MICA, DIEL	EA	1
30	19	PAFZZ		X663F-105-100-5	92741	CAPACITOR, FIXED, MICA, DIEL	EA	1
30	20	PAFDD	5820-01-020-2205	NF116-3	82679	OSCILLATOR, OVENIZED	EA	1
						GROUP 030301160101		
						CIRCUIT CARD A		
						Z304		
31		PAHDD		5820-01-010-4986	A4512	CIRCUIT CD, A	EA	1
31	1	PAFZZ	5910-00-102-8031	39D157G075FJ4	56289	CAPACITOR, FIXED, ELECTROLYTIC	EA	2
31	2	PADZZ	5961-00-469-2216	MDA970-3	01295	SEMICONDUCTOR DEVICE, DIODE	EA	1
31	3	PADZZ	5910-00-952-5624	39D207G050FJ4	56289	CAPACITOR, FIXED, ELECTROLYTIC	EA	2
31	4	XDHZZ		PC329	82679	PRINTED WIRING BOARD	EA	1
31	5	XBDZZ		MS6055	82679	CLAMP, CAP	EA	1
31	6	XBDZZ		SCBP0440BN5	82679	SCREW, MACHINE	EA	1
31	7	PADZZ		LWE04MRN	82679	WASHER, LOCK	EA	1
31	8	XBDZZ		MS6063	82679	RESISTOR, VARIABLE, COMPOSITION	EA	2
31	9	XBDZZ	5310-00-171-8727	NTH0440BN6	82679		EA	1
31	10	XBFZZ		SC131-0632BN6	82679	SCREW, MACHINE	EA	1
31	11	XBDZZ		FW04LBN	82679	WASHER, FLAT	EA	1
31	12	PADZZ		LWE04MRN	82679	WASHER, LOCK	EA	1
						GROUP 030301160102		
						CIRCUIT CARD B		
						Z303		
32		PAHDD	5820-01-022-9716	A4513	82679	CIRCUIT CD, B	EA	1
32	1	PADZZ		62P1000	80740	RESISTOR, VARIABLE, COMPOSITION	EA	3
32	2	PADZZ	5961-00-901-4862	2N3638	81349	TRANSISTOR	EA	2
32	3	PADZZ	5905-00-110-7620	RC07GF102J	81349	RESISTOR, FIXED, COMPOSITION	EA	5
32	4	PADZZ	5961-00-752-6121	1N753A	81349	SEMICONDUCTOR DEVICE, DIODE	EA	2
32	5	PADZZ	5905-00-114-0711	RC07GF472J	81349	RESISTOR, VARIABLE, COMPOSITION	EA	2

REPAIR PARTS LIST

SECTION II REPAIR PARTS LIST

(1) ILLUSTRATION		(2)	(3)	(4)	(5)	(6) DESCRIPTION	(7)	(8)
(a) FIG NO.	(b) ITEM NO.	SMR CODE	NATIONAL STOCK NUMBER	PART NUMBER	FSCM	USABLE ON CODE	U/M	QTY INC IN UNIT
32	6	PADZZ	5910-00-913-4473	62F305	01002	CAPACITOR, FIXED, ELECTROLYTIC	EA	5
32	7	PADZZ	5905-00-854-6592	453E1005	56289	RESISTOR, FIXED WIREWOUND	EA	1
32	8	PADZZ		62P10K	80740	RESISTOR, VARIABLE, COMPOSITION	EA	1
32	9	PADZZ		2N1481	81349	TRANSISTOR	EA	5
32	10	PADZZ	5905-00-119-8811	RC07GF151J	81349	RESISTOR, FIXED, COMPOSITION	EA	2
32	11	PADZZ	5905-00-120-9154	RC07GF471J	81349	RESISTOR, FIXED, COMPOSITION	EA	1
32	12	PADZZ	5961-00-311-2860	1N4619	81349	SEMICONDUCTOR DEVICE, DIODE	EA	2
32	13	PADZZ	5905-00-106-1356	RC07GF152J	81349	RESISTOR, FIXED, COMPOSITION	EA	1
32	14	PADZZ	5905-00-106-3666	RC07GF103J	81349	RESISTOR, FIXED, COMPOSITION	EA	1
32	15	PADZZ	5961-00-866-6720	1N100	81349	SEMICONDUCTOR DEVICE, DIODE	EA	2
32	16	PADZZ	5905-00-110-7622	RC07GF682J	81349	RESISTOR, FIXED, COMPOSITION	EA	1
32	17	XDHZZ		PC330	82679	PRINTED WIRING BOARD	EA	1
32	18	PADZZ	5961-00-850-9561	1N9728	81349	SEMICONDUCTOR DEVICE, DIODE	EA	1
32	19	XBDZZ		MS6063	82679	STIFFENER, PC BOARD	EA	1
32	20	XBDZZ	5310-00-171-8727	NTH0440BN6	82679	NUT, PLAIN, HEXAGON	EA	1
32	21	XBDZZ		SCBP0440BN5	82679-	SCREW, MACHINE	EA	1
32	22	XBDZZ		FW004HBN	82679	WASHER, FLAT	EA	1
32	23	XBDZZ		PX829-3	82679	RETAINER, TRANSISTOR	EA	7
						GROUP 030301160106 CIRCUIT CARD, RISER		
33		PAHZZ	5820-01-012-5464	A4563	82679	CIRCUIT CD, RISER	EA	1
33	1	XBDZZ		JJ319-6DPE	82679	CONNECTOR, RECEPTACLE, ELEC	EA	1
33	2	XDHZZ		PC355	82679	PRINTED WIRING BOARD	EA	1
						GROUP 0305 FAN, AXIAL, MUFFIN TYPE		
34		XDFFF	4140-00-060-1131	F1C2	82877	FAN, AXIAL, MUFFIN TYPE	EA	4
34	1	PAFZZ		478031	82877	GRILLE KIT	EA	1
34	2	PAFZZ		028021	82877	FAN LESS GRILLE KIT	EA	1
34	3	PAFZZ		271016	82877	MOUNTING CLIPS	EA	2
						GROUP 0306 EXHAUST DUCT		
35		XDFFF		V4210MA	20418	EXHAUST DUCT	EA	1
35	1	XBFZZ		41000005000	20418	NUT, BRASS HUB	EA	1

SECTION II REPAIR PARTS LIST

(1) ILLUSTRATION		(2)	(3)	(4)	(5)	(6) DESCRIPTION	(7)	(8)
(a) FIG NO.	(b) ITEM NO.	SMR CODE	NATIONAL STOCK NUMBER	PART NUMBER	FSCM	USABLE ON CODE	U/M	QTY INC IN UNIT
35	2	XBFZZ		12100017000	20418	BLADE	EA	2
35	3	XBFZZ		SM8396980	80063	SCREW, SET	EA	1
35	4	XBFZZ		27030003002	20418	HUB	EA	1
35	5	PAFZZ		39000002000	20418	MOTOR AND PLUG ASSY	EA	1
35	6	XBFZZ		14090001000	20418	CUSHION	EA	2
35	7	XBFZZ		12225001008	20418	BOLT, FRONT RETAINING	EA	1
35	8	XBFZZ		39020128000	20418	VENTURI AND MOTOR MOUNT	EA	1
35	9	XBFZZ		41000095000	20418	NUT, ADJUSTMENT	EA	1
3S	10	XBFZZ		64015048000	20418	WASHER	EA	1
35	11	XBFZZ		41005009000	20418	NUT, KEPS	EA	1
35	12	XBFZZ		25020006000	20418	GROMMET, RUBBER	EA	1
						GROUP 0402 PANEL, PATCH, ANTENNA		
36		XDFFD	1047-00-403-0111		82679	PANEL, PATCH, ANTENNA	EA	1
36	1	PAFZZ	5935-00-404-7965	S0-239	81349	CONNECTOR, RECEP, ELECTRICAL	EA	6
36	2	PAFZZ	5145-00-161-0885	RG11AU	96906	CABLE, RADIO FREQUENCY	EA	2
36	3	PAFZZ	5335-00-257-8996	83J9	02660	CONNECTOR, PLUG, ELECTRICAL	EA	4
						GROUP 0501 PANEL, LINE BATTERY SUPPLY NO. 1 NRC TYPE 227		
37		PAFFF	6145-00-191-3231	2-16AWG	81349	CABLE, POWER, ELECTRICAL	EA	4
37	1	PAFZZ	5935-00-857-6547	S202CCT	07233	CONNECTOR, PLUG, ELECTRICAL	EA	2
37	2	PAFZZ	5935-00-636-7145	UP1Z1M	96906	CONNECTOR, PLUG	EA	2
37	3	PAFZZ	5930-00-655-1582	MS35059-24	96906	SWITCH, TOGGLE	EA	2
37	4	PAFZZ	5920-00-050-4953	F02G1R50A	96906	FUSE, CARTRIDGE	EA	4
37	5	PAFZZ	5920-00-280-9328	MDL1-1-2	71400	FUSE, CARTRIDGE	EA	2
37	6	PAFZZ	5930-00-615-7877	MS35059-24	96906	SWITCH, TOGGLE	EA	2
37	7	PAFZZ	5805-00-850-0070	227MOD1	88183	PANEL, LINE BATTERY SUPPLY NO. 1	EA	2

REPAIR PARTS LIST

SECTION II REPAIR PARTS LIST

(1) ILLUSTRATION		(2)	(3)	(4)	(5)	(6) DESCRIPTION	(7)	(8)
(a) FIG NO.	(b) ITEM NO.	SMR CODE	NATIONAL STOCK NUMBER	PART NUMBER	FSCM	USABLE ON CODE	U/M	QTY INC IN UNIT
37	8	PAFFF	5935-00-646-5890	26-4201-85	02660	CONNECTOR, RECEP, ELECTRICAL	EA	4
37	9	PAFFF	5935-00-257-8546	P202B	07233	CONNECTOR, RECEP, ELECTRICAL	EA	2
37	10	PAFFF	5945-00-893-7375	KRP11D	02470	RELAY, ARMATURE	EA	2
37	11	PAFFF	5935-00-129-9358	TS101P02	81349	SOCKET, ELECTRON TUBE	EA	2
37	12	PAFFF	6240-00-223-9100	NE51	24455	LAMP, GLOW	EA	2
37	13	PAFFF	6210-00-851-6307	26408-1137	72619	LIGHT, INDICATOR	EA	2
37	14	PAFFF	5920-00-553-7116	HKLX	71400	FUSEHOLDER	EA	6
						GROUP 0502 RED PATCH PANEL		
38	1	PAFZZ	5935-00-815-4721	MT332C	82389	JACK, TELEPHONE	EA	45
38	2	PAFZZ	5935-00-192-4808	SM847610	80063	JACK, TELEPHONE	EA	45
						GROUP 0503 ALARM UNIT		
39	1	PAFZZ	6210-00-186-7916	95-457	72619	LIGHT, INDICATOR	EA	2
39	2	PAOZZ	6240-00-223-9100	NE51	81349	LAMP, GLOW	EA	2
39	3	PAOZZ	6210-00-030-2444	95-937	72619	LENS, INDICATOR LIGHT, CLEAR	EA	2
39	4	PAFZZ	5930-00-549-0308	20905FR	04009	SWITCH, TOGGLE	EA	1
39	5	PAFZZ	6350-00-000-8978	347-3	80252	BELL, ELECTRICAL	EA	1
39	6	PAFZZ	5930-00-723-5091	73168TYPEK	73168	SWITCH, THERMOSTATIC	EA	2
39	7	PAFZZ	5961-00-577-6214	1N538	81349	SEMICONDUCTOR DEVICE	EA	1
39	8	PAFZZ	5905-00-060-1939	35TR100	148411	RESISTOR, FIXED, WIREWOUND	EA	1
39	9	PAFZZ	5935-00-646-5908	9754	74545	CONNECTOR, PLUG, ELECTRICAL	EA	1
39	10	PAFZZ	6145-00-059-8771	199-2-3-0300	97983	CABLE, POWER, ELECTRICAL	EA	3
						GROUP 0506 CLOCK		
40	1	PAFZZ	6645-00-892-4369	MODEL P642TYEP A	117551	CLOCK, WALL	EA	1
						GROUP 0507 SPOTLIGHT		
41	1	PAFZZ	6240-00-886-3256	EZ24BM	99872	FIXTURE, LIGHTING, SWIVEL BASE	EA	1
41	2	PAFZZ	5935-00-646-5908	9754	74545	CONNECTOR, PLUG, ELECTRICAL	EA	1
41	3	PAFZZ	6145-00-059-8771	199-2-3-0330	97983	CABLE, POWER, ELECTRICAL	EA	1
						GROUP 0508 LOCAL BATTERY LOOP CONTROL NO. 3		
42	1	PAFZZ	5905-00-108-5445	RP101FD2J2KK	96906	RESISTOR, VARIABLE	EA	9
42	2	PAFZZ	5355-00-823-9810	MS25168-P18	81349	KNOB, ROUND	EA	9

SECTION II REPAIR PARTS LIST

(1) ILLUSTRATION		(2)	(3)	(4)	(5)	(6) DESCRIPTION	(7)	(8)
(a) FIG NO.	(b) ITEM NO.	SMR CODE	NATIONAL STOCK NUMBER	PART NUMBER	FSCM	USABLE ON CODE	U/M	QTY INC IN UNIT
						GROUP 0603 POWER ; SUPPLY, RED/BLACK		
43	1	XDFFF		SRD10-15	82679	POWER, SUPPLY	EA	2
43	2	PAFZZ		1042C	72563	GROMMET, RUBBER	EA	1
43	3	PAFZZ		1045C	72563	GROMMET, RUBBER	EA	1
43	4	PAFZZ		833	22212	CLAMP, ELECTRICAL	EA	1
43	5	PAFZZ	5920-00-031-5181	HTA	00628	FUSEHOLDER	EA	2
43	6	PAFZZ	5920-00-199-9498	MODEL 1	00628	FUSE, CARTRIDGE	EA	2
43	7	PAFZZ	5935-00-470-9267	5384	75582	CONNECTOR, PLUG, ELECTRICAL	EA	1
43	8	PAFZZ	6145-00-350-3497	8453	70903	CABLE, POWER, ELECTRICAL	EA	4
						GROUP 0701 PANEL , PATCH, SECURE NO. 1		
44	1	PAFZZ	6210-00-030-2444	95-937	72619	LENS, INDICATOR, LIGHT, CLEAR	EA	2
44	2	PAFZZ	6210-00-186-7916	95-457	72619	LIGHT, INDICATOR	EA	2
44	3	PAFZZ	6240-00-223-9100	NE51	81349	LAMP, GLOW BAYONET BASE	EA	2
44	4	PAFZZ	5935-00-247-8406	223-1217	82679	CONNECTOR	EA	8
44	5	PAFZZ		220P02	82679	CONTACTS	EA	28
44	6	PAFZZ	5935-00-247-8405	223-1117	82679	CONNECTOR	EA	4
44	7	PAFZZ		TAC220502	82679	CONTACTS	EA	28
						GROUP 0703 BOX, LOW LEVEL INTERFACE NO. 1		
45	1	PAFZZ	5935-00-470-9267	5384	75582	CONNECTOR, PLUG, ELECTRICAL	EA	1
45	2	PAFZZ	5920-00-031-5181	HTA	00628	FUSEHOLDER	EA	2
45	3	PAFZZ	5920-00-199-8898	05W	00628	FUSE, CARTRIDGE	EA	2
45	4	PAFZZ	6145-00-350-3497	8453	70903	CABLE, POWER, ELECTRICAL	EA	2
45	5	PAFZZ	5325-00-174-5317	GC1045C	96906	GROMMET, RUBBER	EA	3
45	6	PAFZZ	5340-00-150-3045	9726A0440	06540	STANDOFF, HEX	EA	6
45	7	PAFZZ	5910-00-280-8393	A1174	81349	CAPACITOR, DIELECTRIC	EA	2
45	8	PAFZZ	5815-00-434-2603	4-19009	99028	ADC MODULE	EA	2

SECTION II REPAIR PARTS LIST

(1) ILLUSTRATION		(2)	(3)	(4)	(5)	(6) DESCRIPTION	(7)	(8)
(a) FIG NO.	(b) ITEM NO.	SMR CODE	NATIONAL STOCK NUMBER	PART NUMBER	FSCM	USABLE ON CODE	U/M	QTY INC IN UNIT
45	9	PAFZZ		3-331677-2	99028	CONNECTOR, SOCKET, PIN	EA	20
45	10	PAFZZ	5905-00-063-7573	10015579-193	81349	RESISTOR, FIXED CARBON	EA	2
45	11	PAFZZ	5905-00-141-0599	EB3925	81349	RESISTOR, FIXED CARBON	EA	2
45	12	PAFZZ	5961-00-715-1051	2N916	81349	TRANSISTOR	EA	2
45	13	PAFZZ	5815-00-001-0635	4-19008TYPE 1	99028	ADC MODULE	EA	2
45	14	PAFZZ	5905-00-835-9515	R52-2500±1%	81349	RESISTOR, FIXED CARBON	EA	2
45	15	PAFZZ	6130-00-002-8804	MODEL 408	17191	POWER SUPPLY	EA	3
45	16	PAFZZ	5905-00-110-0993	12K	81349	RESISTOR, FIXED CARBON	EA	2
45	17	PAFZZ	5910-00-483-5618	MIL-C-11015-19	81349	CAPACITOR, DIELECTRICL	EA	2
						GROUP 0801 PANEL, CURRENT LIMITER		
46	1	PAOZZ		MS91528-1P2D	96906	KNOB, CONTROL, ROUND	EA	16
46	2	PAFZZ	5905-00-195-2353	RP101FK252KK	96906	RESISTOR, VARIABLE	EA	1
						GROUP 0802 PATCH PANEL		
47		XDFFF		ANFTA28	82679	PANEL, PATCH	EA	1
47	1	PAFZZ	5935-00-686-0311	PJ339	70674	JACK, TELEPHONE	EA	20
47	2	PAFZZ	5935-00-815-4721	WEC0239A	70674	JACK, TELEPHONE	EA	20
						GROUP 0901 PANEL, DUAL SPEAKER AND AMPLIFIER, TYPE 414A		
48		XDFFF		414A	81679	PANEL, DUAL SPEAKER AND AMPLIFIER. TYPE 414A	EA	1
48	1	PAFZZ	5965-00-874-6941	SK11	13499	LOUDSPEAKER, PERMANENT MAGNET	EA	2
48	2	PAFZZ	5355-00-160-7108	1400	72512	KNOB, FOR AMPLIFIER	EA	2
48	3	PAFZZ	5910-00-885-8552	TMD2	83125	CAPACITOR, FIXED, ELECTROLYTIC	EA	1
48	4	PAFZZ	5961-00-826-0053	2N307	80131	TRANSISTOR, GERMANIUM	EA	3
48	5	PAOZZ	5920-00-284-9494	F02GR750A	81349	FUSE, CARTRIDGE	EA	1
48	6	PAFZZ	5920-00-280-4167	342003	75915	FUSEHOLDER	EA	1

SECTION II REPAIR PARTS LIST

(1) ILLUSTRATION		(2)	(3)	(4)	(5)	(6) DESCRIPTION	(7)	(8)
(a) FIG NO.	(b) ITEM NO.	SMR CODE	NATIONAL STOCK NUMBER	PART NUMBER	FSCM	USABLE ON CODE	U/M	QTY INC IN UNIT
48	7	PAFZZ	5950-00-885-5883	P18016	11190	TRANSFORMER, AUDIO FREQUENCY	EA	1
48	8	PAFZZ	5935-00-149-5453	P306AB	07233	CONNECTOR RECP, ELECTRICAL	EA	1
48	9	PAFZZ		F40X	81095	TRANSFORMER, POWER, STEP DOWN	EA	1
48	10	PAFZZ	5961-00-885-8598	2TS4	07233	SOCKET, SEMICONDUCTOR DEVICE	EA	2
48	11	PAFZZ	5960-00-899-6822	1N1763	80131	SEMICONDUCTOR, DEVICE, DIODE	EA	2
48	12	PAFZZ	5905-00-885-5914	P13-485010	11190	RESISTOR, FIXED	EA	2
48	13	PAFZZ	5950-00-885-5885	P18015	11190	TRANSFORMER, AUDIO FREQUENCY	EA	1
48	14	PAFZZ	5905-00-101-7907	RC32GF6R8J	81349	RESISTOR, FIXED, COMPOSITION	EA	2
48	15	PAFZZ	5950-00-885-5886	P18014	11190	TRANSFORMER, AUDIO FREQUENCY	EA	1
48	16	PAFZZ	5910-00-691-1242	TE1102	56289	CAPACITOR, FIXED, ELECTROLYTIC	EA	1
48	17	PAFZZ	5905-00-171-2006	RC20GF271J	81349	RESISTOR, FIXED, COMPOSITION	EA	1
48	18	PAFZZ	5905-00-279-1876	RC20GF222J	81349	RESISTOR, FIXED, COMPOSITION	EA	1
48	19	PAFZZ	5905-00-279-2651	RC32GF821J	81349	RESISTOR, FIXED, COMPOSITION	EA	1
48	20	PAFZZ	5905-00-063-6318	JS1N200P151UA	08313	RESISTOR, VARIABLE	EA	1
						GROUP 0902 PANEL, MULTIPLE REPEAT		
49	1	PAFZZ	5910-00-112-7529	CP53B1FF254V	81350	CAPACITOR, FIXED, PAPER	EA	17
49	2	PAFZZ		10F2250	63743	RESISTOR, FIXED	EA	16
49	3	PAFZZ	5905-00-833-5511	10F2000	63743	RESISTOR, FIXED	EA	2
49	4	PAFZZ	5945-00-518-9836	72A0Z160TGTC	78277	RELAY, ARMATURE, SPDT	EA	9
49	5	PAFZZ	5935-00-163-0004	MIP88-8	02660	SOCKET ELECTRON TUBE	EA	9
49	6	PAFZZ	5930-00-820-9131	T2150-28V	82389	SWITCH, TOGGLE, DPDT	EA	8
49	7	PAFZZ	5920-00-577-2264	344.125	75915	FUSEHOLDER	EA	3
49	8	PAOZZ	5920-00-356-2188	312.175	75915	FUSE, CARTRIDGE	EA	3
49	9	PAFZZ	5935-00-886-3251	90S08X	90044	JACK, TELEPHONE	EA	3
						GROUP 0903 RECEIVER, RADIO R-1981/TSC-5		
50		PDFFD	5820-00-149-1118	R1981TSC25	80063	RADIO, RECEIVER R-1981/TSC-25	EA	1
50	1	XBFZZ		SM249132	80063	COVER TOP	EA	1
50	2	XBFZZ	5305-00-054-6650	MS35216-23	96906	SCREW, MACHINE	EA	16
50	3	XBFZZ		SMD343622-1	80063	WASHER, FLAT	EA	16
50	4	XBFZZ	5310-00-929-6395	MS35338-79	96906	WASHER, SPLIT	EA	16
50	5	XBFZZ		SMD249131	80063	COVER, BOTTOM	EA	1
						GROUP 090301 RECEIVER ASSEMBLY A1		
50	6	PDFFD		SMD343619	80063	RECEIVER ASSEMBLY	EA	1
50	7	PAFZZ	5935-00-204-6389	SMC283179	80063	CONNECTOR, RECEPTACLE, ELECTRICAL	EA	1
50	8	PAFZZ		SMB283200	80063	CONNECTOR, PLUG, ELECTRICAL	EA	1
50	9	PAFZZ	5935-00-204-6391	SMB283181	80063	CONNECTOR, PLUG, ELECTRICAL	EA	1
50	10	PAFZZ		SNB283183	80063	CONNECTOR, PLUG, ELECTRICAL	EA	1

SECTION II REPAIR PARTS LIST

(1) ILLUSTRATION		(2)	(3)	(4)	(5)	(6) DESCRIPTION	(7)	(8)
(a) FIG NO.	(b) ITEM NO.	SMR CODE	NATIONAL STOCK NUMBER	PART NUMBER	FSCM	USABLE ON CODE	U/M	QTY INC IN UNIT
50	11	XBFZZ		41TB8	81349	TERMINAL BOARD	EA	2
50	12	PAFZZ	5961-00-953-2607	1N933	81349	SEMICONDUCTOR DEVICE, DIODE	EA	1
50	13	PAFZZ		SMC283177	80063	RECTIFIER, METALLIC	EA	1
50	14	PAFZZ	5950-00257-2631	RC20GF682K	81349	RESISTOR, FIXED, COMPOSITION	EA	1
50	15	PAFZZ	5905-00-257-2631	RC20GF821K	81349	RESISTOR, FIXED, COMPOSITION	EA	1
50	16	PAFZZ		SMB283195	80063	CONNECTOR, PLUG, ELECTRICAL	EA	2
50	17	PAFZZ		MS24055-1	96906	CONNECTOR, PLUG, ELECTRICAL	EA	2
50	18	PAFZZ	5910-00-131-1319	CK06BX184K	81349	CAPACITOR, FIXED, CERAMIC	EA	1
50	19	PAFZZ		SMB249221	80063	FILTER, RADIO INTERFERENCE	EA	1
50	20	PAFZZ	5920-00-894-2387	MS90078-27-1	96906	FUSE, CARTRIDGE	EA	1
50	21	PAFZZ		SMB178480	80063	SWITCH, TOGGLE	EA	1
50	22	PAFZZ	5910-00-867-6123	SMB283227	80063	CAPACITOR, FIXED, CERAMIC	EA	1
50	23	PAFZZ		SMC383192	80063	CONNECTOR, PLUG, ELECTRICAL	EA	1
						GROUP 09030101 AUDIO ASSEMBLY A 2		
51		PDFFD		SMD348801	80063	AUDIO ASSEMBLY	EA	1
51	1	PAFZZ	5915-00-504-7560	SMC283218	80063	FILTER, BAND PASS	EA	1
51	2	PAFZZ	5910-00-018-8781	CE53C300N	81349	CAPACITOR, FIXED, ELECTROLYTIC	EA	1
51	3	PAHZZ	5910-00-889-4302	CE52C450N	81349	CAPACITOR, FIXED, ELECTROLYTIC	EA	1
51	4	PAFZZ	5950-00-831-2825	SMC283220	80063	REACTOR	EA	1
51	5	PAFZZ	5950-00-510-1771	SMC283219	80063	REACTOR	EA	1
51	6	PAHZZ	5950-00-567-2579	SMC283275	80063	TRANSFORMER, AUDIO FREQUENCY	EA	2
51	7	PAFZZ	5960-00-188-3551	6AK6	81349	ELECTRON TUBE	EA	2
51	8	PAHZZ	5950-00-295-7304	SMC283276	80063	REACTOR	EA	1
51	9	PAFZZ	5960-00-262-0210	5814A	81349	ELECTRON TUBE	EA	2
51	10	PAFZZ	5960-00-188-3564	OA2W	81349	ELECTRON TUBE	EA	1
51	11	PAFZZ	5630-00-201-7922	SMB283184	80063	CONNECTOR, RECEPTACLE	EA	1
51	12	PAFZZ	5945-00-204-6392	SMC283244	80063	RELAY, ARMATURE	EA	1
51	13	PAFZZ	5935-00-295-5006	SMC283194	80063	CONNECTOR, RECEPTACLE, ELECTRICAL	EA	1
51	14	PAFZZ		SMC283191	80063	CONNECTOR, RECEPTACLE, ELECTRICAL	EA	1
51	15	PAFZZ	5905-00-894-3488	RW30V821	81349	RESISTOR, FIXED, WIREWOUND	EA	1
51	16	PAFZZ	5905-00-734-1549	RRC20G152JS	81349	RESISTOR, FIXED, COMPOSITION	EA	1
51	17	PAHZZ	5935-00-132-2405	TS102P01	81349	SOCKET, ELECTRON TUBE	EA	3
51	18	PAFZZ	5905-00116-8556	RRC07G223JS	81349	RESISTOR, FIXED, COMPOSITION	EA	1
51	19	PAHZZ	5935-00-935-2231	TS101P01	81349	SOCKET, ELECTRON TUBE	EA	2
51	20	PAHZZ	5905-00-141-1071	RC20GF474K	81349	RESISTOR, FIXED, COMPOSITION	EA	1
51	21	PAFZZ	5935-00-222-9828	TS103P01	81349	SOCKET, ELECTRON TUBE	EA	2
51	22	PAFZZ	5905-00-681-6462	RRC07G102JS	81349	RESISTOR, FIXED, COMPOSITION	EA	1
51	23	PAFZZ	5905-00-141-0592	RC20GF122J	81349	RESISTOR, FIXED, COMPOSITION	EA	1
51	24	PAFZZ	5905-00-221-5842	RC20GF684K	81349	RESISTOR, FIXED, COMPOSITION	EA	1
51	25	PAFZZ	5905-00-105-7764	RRC07G222JS	81349	RESISTOR, FIXED, COMPOSITION	EA	1

SECTION II REPAIR PARTS LIST

(1) ILLUSTRATION		(2)	(3)	(4)	(5)	(6) DESCRIPTION	(7)	(8)
(a) FIG NO.	(b) ITEM NO.	SMR CODE	NATIONAL STOCK NUMBER	PART NUMBER	FSCM	USABLE ON CODE	U/M	QTY INC IN UNIT
51	26	PAFZZ		RC20GF276K	81349	RESISTOR, FIXED, COMPOSITION	EA	1
51	27	PAFZZ	5905-00-252-1046	RC20GF275J	81349	RESISTOR, FIXED, COMPOSITION	EA	1
51	28	PAHZZ	5910-00-821-4702	SMC283241-2	80063	CAPACITOR, FIXED, PAPER	EA	1
51	29	PAFZZ	5905-00-221-5842	RC20GF684K	81349	RESISTOR, FIXED, COMPOSITION	EA	1
51	30	PAFZZ	5910-00-932-5724	CM15C680GN3	81349	CAPACITOR, FIXED, MICA	EA	1
51	31	PAFZZ	5910-00-667-6123	SMB283227	80063	CAPACITOR, FIXED, CERAMIC	EA	1
51	32	PAHZZ	5905-00-111-1071	RC20GF474K	81349	RESISTOR, FIXED, COMPOSITION	EA	1
51	33	PAHZZ	5905-00-110-0196	RC20GF102K	81349	RESISTOR, FIXED, COMPOSITION	EA	1
51	34	PAHZZ	5910-00-821-7071	SMC283241-3	80063	CAPACITOR, FIXED, PAPER	EA	1
51	35	PAFZZ	5905-00-247-8735	RC32GF563K	81349	RESISTOR, FIXED, COMPOSITION	EA	1
51	36	PAHZZ	5905-00-111-8372	RC32GF222J	81349	RESISTOR, FIXED, COMPOSITION	EA	1
51	37	PAHZZ	5910-00-821-4702	SMC283241-2	80063	CAPACITOR, FIXED, PAPER	EA	4
51	38	PAFZZ	5905-00-133-0379	RC32GF184J	81349	RESISTOR, FIXED, COMPOSITION	EA	2
51	39	PAHZZ	5910-00-783-9397	CL65CH080KP3	81349	CAPACITOR, FIXED, ELECTROLYTIC	EA	1
51	40	PAFZZ	5905-00-104-8351	RC32GF154J	81349	RESISTOR, FIXED, COMPOSITION	EA	1
51	41	PAHZZ	5905-00-111-8357	RC20GF681J	81349	RESISTOR, FIXED, COMPOSITION	EA	2
51	42	PAHZZ	5905-00-111-4734	RC20GF470K	81349	RESISTOR, FIXED, COMPOSITION	EA	1
51	43	PAHZZ	5905-00-104-8355	RC32GF561K	81349	RESISTOR, FIXED, COMPOSITION	EA	2
51	44	PAFZZ	5905-00-247-8715	RC32GF224J	81349	RESISTOR, FIXED, COMPOSITION	EA	1
51	45	PAHZZ	5905-00-104-8345	RC20GF560J	81349	RESISTOR, FIXED, COMPOSITION	EA	1
51	46	PAFZZ	5905-00-636-6742	R26BRW31V162	81349	RESISTOR, FIXED, WIREWOUND	EA	1
51	47	PAFZZ	5905-00-636-7787	R26CR31V122	81349	RESISTOR, FIXED, WIREWOUND	EA	1
						GROUP 09030102 AMPLIFIER SUBASSEMBLY A1A3		
52		PDFFD		SM0343620	80063	AMPLIFIER, SUBASSEMBLY A1A3	EA	1
52	1	PAFZZ		SMC283241-1	80063	CAPACITOR, FIXED, PAPER	EA	2
52	2	PAHZZ	5935-00-132-2405	TS102P01	81349	SOCKET, ELECTRON TUBE	EA	5
52	3	PAFZZ	5905-00-104-8339	RC20F824K	81349	RESISTOR, FIXED., COMPOSITION	EA	1
52	4	PAFZZ		CM15C470GN3A	81349	CAPACITOR, FIXED, MICA	EA	1
52	5	PAFZZ	5910-00-835-3513	SMB283238	80063	CAPACITOR, FIXED, PAPER	EA	5
52	6	PAFZZ	5910-00-772-1820	CM15F181GN3	81349	CAPACITOR, FIXED, MICA	EA	1
52	7	PAFZZ		CM15C470GN3	81349	CAPACITOR, FIXED, MICA	EA	1
52	8	PAFZZ	5905-00-104-8333	RC20GF184J	81349	RESISTOR, FIXED, COMPOSITION	EA	1
52	9	PAFZZ	5905-00-104-8336	RC20GF104K	81349	RESISTOR, FIXED, COMPOSITION	EA	2
52	10	PAFZZ	5935-00-222-9828	TS1003P01	81349	SOCKET, ELECTRON TUBE	EA	3
52	11	PAFZZ	5905-00-111-4742	RC20GF391J	81349	RESISTOR, FIXED, COMPOSITION	EA	1
52	12	PAHZZ	5905-00-110-0196	RC20GF102K	81349	RESISTOR, FIXED, COMPOSITION	EA	1
52	13	PAFZZ	5950-00-510-7678	SMC249220	80063	COIL, RADIO FREQUENCY	EA	1
52	14	PAFZZ	5905-00-116-8561	RC20GF270J	81349	RESISTOR, FIXED, COMPOSITION	EA	1
52	15	PAFZZ	5910-00-666-6558	CM25E102J	80063	CAPACITOR, FIXED, MICA	EA	1
52	16	XBFZZ	5935-00-850-2250	SM8283178	80063	JACK, TIP	EA	3

SECTION II REPAIR PARTS LIST

(1) ILLUSTRATION		(2)	(3)	(4)	(5)	(6)	(7)	(8)
(a) FIG NO.	(b) ITEM NO.	SMR CODE	NATIONAL STOCK NUMBER	PART NUMBER	FSCM	DESCRIPTION USABLE ON CODE	U/M	QTY INC IN UNIT
52	17	PAFZZ	5910-00-667-6123	SMB283227	80063	CAPACITOR, FIXED, CERAMIC	EA	1
52	18	PAFZZ	5905-00-837-1710	RW30V3R9	81349	RESISTOR, FIXED, WIREWOUND	EA	1
52	19	PAHZZ	5910-00-821-4702	SMC283241-2	80063	CAPACITOR, FIXED, PAPER	EA	1
52	20	PAFZZ	5935-00-660-5590	SMC283188	80063	CONNECTOR, RECEPTACLE, ELECTRICAL	EA	1
52	21	PAFZZ	5910-00-667-6123	SMB283227	80063	CAPACITOR, FIXED, CERAMIC	EA	4
52	22	PAFZZ	5905-00-104-5757	RC32GF273J	81349	RESISTOR, FIXED, COMPOSITION	EA	1
52	23	PAFZZ	5910-00-543-9197	SM8283237	80063	CAPACITOR, FIXED, PAPER	EA	2
52	24	PAFZZ	5950-00-387-0489	SMC178905	80063	CHOKE, RADIO	EA	1
52	25	PAFZZ	5950-00-647-9191	SMD249234	80063	TRANSFORMER, INTERMEDIATE, FREQ	EA	1
52	26	PAFZZ	5905-00-942-9326	RC20GF561K	81349	RESISTOR, FIXED, COMPOSITION	EA	1
52	27	PAFZZ	5905-00-104-8330	RC20GF333K	81349	RESISTOR, FIXED, COMPOSITION	EA	1
52	28	PAFZZ		CM15F101GN3	81349	CAPACITOR, FIXED, MICA	EA	2
52	29	PAFZZ		1RC2G6KA	81349	RESISTOR, FIXED, COMPOSITION	EA	1
52	30	PAFZZ	5905-00-106-1282	RC20GF223K	81349	RESISTOR, FIXED, COMPOSITION	EA	1
52	31	PAFZZ	5930-00-548-5008	SMC249232	80063	SWITCH, SECTION ROTARY	EA	1
52	32	PAHZZ	5910-00-821-7071	SMC283241-3	80063	CAPACITOR, FIXED, PAPER	EA	1
52	33	PAFZZ		SMB249233	80063	SWITCH, SECTION ROTARY	EA	1
52	34	PAFZZ	5905-00-141-1168	RC20GF222J	81349	RESISTOR, FIXED, COMPOSITION	EA	1
52	35	PAFZZ	5905-00-279-2527	RC42GF223J	81349	RESISTOR, FIXED, COMPOSITION	EA	1
52	36	PAFZZ	5915-00-646-5241	SMD248860	80063	FILTER, BANDPASS	EA	1
52	37	PAFZZ	5915-00-711-0388	SMD248863	80063	FILTER, BANDPASS	EA	1
52	38	PAFZZ	5910-00-871-5935	551-06	72982	CAPACITOR, VARIABLE	EA	4
52	39	PAFZZ	5910-00-932-2738	CM15C820G03	81349	CAPACITOR, FIXED, MICA	EA	6
52	40	PAFZZ	5915-00-523-1961	SMD248861	80063	FILTER, BANDPASS	EA	1
52	41	PAFZZ	5950-00-698-1253	SM8249219	80063	COIL, RADIO FREQUENCY	EA	2
52	42	PAFZZ	5915-00-523-1960	SMD248862	80063	FILTER, BANDPASS	EA	1
52	43	PAFZZ	5910-00-850-0540	CM15C510GN3	81349	CAPACITOR, FIXED, MICA	EA	2
52	44	PAHZZ	5905-00-141-1071	RC20GF474K	81349	RESISTOR, FIXED, COMPOSITION	EA	1
52	45	PAFZZ	5905-00-106-9351	RC20GF273K	81349	RESISTOR, FIXED, COMPOSITION	EA	1
52	46	PAFZZ	5905-00-106-9351	RC20GF273K	81349	RESISTOR, FIXED, COMPOSITION	EA	2
52	47	PAFZZ	5910-00-825-1637	CP50A1KC0104K3	80063	CAPACITOR, FIXED, PAPER	EA	1
52	48	PAFZZ	5910-00-993-2380	CM15B120KN3	81349	CAPACITOR, FIXED, MICA	EA	1
52	49	PAFZZ	5905-00-114-5428	RC20GF394J	81349	RESISTOR, FIXED, COMPOSITION	EA	1
52	50	PAFZZ	5905-00-114-5428	RC20GF394J	81349	RESISTOR, FIXED, COMPOSITION	EA	1
52	51	PAFZZ	5905-00-114-5407	RC20GF271K	81349	RESISTOR, FIXED, COMPOSITION	EA	1
52	52	PAFZZ	5905-00-104-5756	RC20GF105J	81349	RESISTOR, FIXED, COMPOSITION	EA	1
52	53	PAFZZ	5935-00-222-9828	TS103P01	81349	SOCKET, ELECTRON TUBE	EA	1
52	54	PAFZZ	5905-00-104-8330	RC20GF333K	81349	RESISTOR, FIXED, COMPOSITION	EA	1
52	55	PAFZZ	5910-00-826-2719	SMB283239	80063	CAPACITOR, FIXED, MICA	EA	1
52	56	PAFZZ	5820-00-851-3898	SMC343625	80063	OSCILLATOR TUNING	EA	1

SECTION II REPAIR PARTS LIST

(1) ILLUSTRATION		(2)	(3)	(4)	(5)	(6) DESCRIPTION	(7)	(8)
(a) FIG NO.	(b) ITEM NO.	SMR CODE	NATIONAL STOCK NUMBER	PART NUMBER	FSCM	USABLE ON CODE	U/M	QTY INC IN UNIT
52	57	PAFZZ	5905-00-114-5489	RC20GF823K	81349	RESISTOR, FIXED, COMPOSITION	EA	2
52	58	PAFZZ	5905-00-106-9344	RC20GF101K	81349	RESISTOR, FIXED, COMPOSITION	EA	2
52	59	PAFZZ	5905-00-106-9351	RC20GF273K	81349	RESISTOR, FIXED, COMPOSITION	EA	2
52	60	PAFZZ	5910-00-649-5094	SMB283228-1	80063	CAPACITOR, VARIABLE	EA	1
52	61	PAFZZ	5905-00-252-1046	RC20GF275J	81349	RESISTOR, FIXED, COMPOSITION	EA	1
52	62	PAFZZ	5905-00-116-8561	RC20GF270J	81349	RESISTOR, FIXED, COMPOSITION	EA	1
52	63	PAFZZ	5905-00-111-8372	RC32GF222K	81349	RESISTOR, FIXED, COMPOSITION	EA	1
52	64	PAFZZ	5905-00-111-8357	RC20GF6B1K	81349	RESISTOR, FIXED, COMPOSITION	EA	1
52	65	PAFZZ	5905-00-114-5393	RC20GF224J	81349	RESISTOR, FIXED, COMPOSITION	EA	1
52	66	PAFZZ	5905-00-247-8749	RC32GF823J	81349	RESISTOR, FIXED, COMPOSITION	EA	1
52	67	PAFZZ		CM15F151GN3	81349	CAPACITOR, FIXED, MICA	EA	1
						GROUP 0903010201 INTERMEDIATE FREQUENCY AMPLIFIER A1A3A4		
53		PAFZZ	5820-00-697-9667	SMC343621	80063	AMPLIFIER, INTERMEDIATE FREQUENCY A1A3A4	EA	1
53	1	PAFZZ	5905-00-192-6390	RC20GF105J	81349	RESISTOR, FIXED COMPOSITION	EA	1
53	2	PAFZZ	5905-00-683-2235	RCR07G680JS	81349	RESISTOR, FIXED, COMPOSITION	EA	1
53	3	PAFZZ		CM15F101GN3	81349	CAPACITOR, FIXED, MICA	EA	2
53	4	PAFZZ		TS103P01	81349	SOCKET, ELECTRON TUBE	EA	2
53	5	PAFZZ	5910-00-270-3196	CM15F221GN3	81349	CAPACITOR, FIXED, MICA	EA	1
53	6	PAFZZ	5910-00-689-8275	CM15F181GN3	81349	CAPACITOR, FIXED, MICA	EA	1
53	7	PAFZZ	5905-00-192-3987	RC20GF104K	81349	RESISTOR, FIXED COMPOSITION	EA	1
53	8	PAFZZ		RC20GF184J	81349	RESISTOR, FIXED, COMPOSITION	EA	1
53	9	PAFZZ	5905-00-126-6683	RCR07G332JS	81349	RESISTOR, FIXED, COMPOSITION	EA	1
53	10	PAFZZ	5910-00-835-3513	SMB283238	80063	CAPACITOR, FIXED, PAPER	EA	2
53	11	PAFZZ	5905-00-111-4742	RC20GF391J	81349	RESISTOR, FIXED, COMPOSITION	EA	1
53	12	PAHZZ		RC20GF102K	81349	RESISTOR, FIXED, COMPOSITION	EA	1
53	13	PAFZZ		SMC249220	80063	COIL, RADIO FREQUENCY	EA	1
53	14	PAFZZ		SMB283227-2	80063	CAPACITOR, FIXED, CERAMIC	EA	1
53	15	PAFZZ		CM25E102J	80063	CAPACITOR, FIXED, MICA	EA	1
53	16	PAFZZ		RC20GF270J	81349	RESISTOR, FIXED, COMPOSITION	EA	1
53	17	XBFZZ	5935-00-850-2250	SM283178	80063	JACK, TIP	EA	3
53	18	PAFZZ	5910-0084-0938	SMC283241-1	80063	CAPACITOR, FIXED, PAPER	EA	2
53	19	PAFZZ	5903-00--837-1710	RW30V3R9	81349	RESISTOR, FIXED, WIREWOUND	EA	1
53	20	PAFZZ		SMC283188	80063	CONNECTOR, RECEPTACLE, ELECTRICAL	EA	1
53	21	PAFZZ		SMB283237	80063	CAPACITOR, FIXED, PAPER	EA	3
53	22	PAFZZ		SMC178505	80063	CHOKER, RADIO	EA	1
53	23	PAFZZ	5905-00-942-9326	RC20GF561K	81349	RESISTOR, FIXED, COMPOSITION	EA	1
53	24	PAFZZ	5905-00-249-4248	RC20GF333K	81349	RESISTOR, FIXED, COMPOSITION	EA	1
53	25	PAFZZ		SMD249234	80063	TRANSFORMER, INTERMEDIATE, FREQ	EA	1
53	26	PAFZZ	5910-00-667-6123	SMB283227	80063	CAPACITOR, FIXED, CERAMIC	EA	4
53	27	PAFZZ	5905-00-229-2620	RC20GF223K	81349	RESISTOR, FIXED, COMPOSITION	EA	1

SECTION II REPAIR PARTS LIST

(1) ILLUSTRATION		(2)	(3)	(4)	(5)	(6)	(7)	(8)
(a) FIG NO.	(b) ITEM NO.	SMR CODE	NATIONAL STOCK NUMBER	PART NUMBER	FSCM	DESCRIPTION USABLE ON CODE	U/M	QTY INC IN UNIT
53	28	PAFZZ	5910-00-010-8666	CK05BX102K	80063	CAPACITOR, FIXED, CERAMIC	EA	1
53	29	PAHZZ	5935-00-222-9829	TS103P01	81349	SOCKET, ELECTRON TUBE	EA	1
53	30	PAFZZ	5905-00-942-9320	RC20GF561K	81349	RESISTOR, FIXED, COMPOSITION	EA	1
53	31	PAFZZ	5930-00-548-5008	1MC249232	80063	SWITCH, SECTION ROTARY	EA	1
53	32	PAFZZ		SMB249233	80063	SWITCH, SECTION ROTARY	EA	2
53	33	PAFZZ		RC32GF273J	81349	RESISTOR, FIXED, COMPOSITION	EA	1
53	34	PAHZZ	5910-00-821-4702	SMC283241-2	80063	CAPACITOR, FIXED, PAPER	EA	1
53	35	PAFZZ	5905-00-279-2527	RC42GF223J	81349	RESISTOR, FIXED, COMPOSITION	EA	1
53	36	PAFZZ	5910-00-727-4995	CM15C820G03	81349	CAPACITOR, FIXED, MICA	EA	3
53	37	PAFZZ	5905-00-279-1738	RC20GF222J	81349	RESISTOR, FIXED COMPOSITION	EA	2
53	38	PAFZZ		SMD248863	80063	FILTER, BANDPASS	EA	1
53	39	PAFZZ		SMB249219	80063	COIL, RADIO, FREQUENCY	EA	1
53	40	PAFZZ	5915-00-646-5241	SMD248860	80063	FILTER, BANDPASS	EA	1
53	41	PAFZZ	5915-00-523-1962	SMD248861	80063	FILTER, BANDPASS	EA	1
53	42	PAFZZ	5910-00-844-9694	CM15C510GN3	81349	CAPACITOR, FIXED, MICA	EA	1
53	43	PAFZZ	5915-00-523-1960	SN0248862	80063	FILTER, BANDPASS	EA	1
53	44	PAHZZ	5910-00-667-5383	SMC283241-2	80063	CAPACITOR, FIXED, PAPER	EA	1
53	45	PAHZZ	5905-00-686-9996	RCR07G821JS	81349	RESISTOR, FIXED COMPOSITION	EA	1
53	46	PAFZZ	5905-00-186-3008	RCR20G101JS	81349	RESISTOR, FIXED COMPOSITION	EA	2
53	47	PAFZZ	5910-00-993-2380	CM158120J03	81349	CAPACITOR, FIXED, MICA	EA	1
53	48	PAFZZ		CP05A1KC104K3	80063	CAPACITOR, FIXED, PAPER	EA	1
53	49	PAHZZ	5905-00-185-6946	RC20GF474K	81349	RESISTOR, FIXED COMPOSITION	EA	1
53	50	PAFZZ	5905-00-279-2517	RC20GF394J	81349	RESISTOR, FIXED COMPOSITION	EA	1
53	51	PAFZZ	5905-00-185-6966	RC20GF271K	81349	RESISTOR, FIXED COMPOSITION	EA	1
53	52	PAFZZ		RC20GF394K	81349	RESISTOR, FIXED COMPOSITION	EA	1
54	1	PAFZZ	5960-00-188-3551	6AK6	81349	ELECTRON TUBE	EA	1
54	2	PAFZZ	5950-00-523-8388	SMD249239	80063	TRANSFORMER, INTERMEDIATE, FREQ	EA	1
54	3	PAFZZ	5905-00-523-8387	SMD249238	80063	TRANSFORMER, INTERMEDIATE, FREQ	EA	2
54	4	PAFZZ	5960-00-262-0210	5814A	81349	ELECTRON TUBE	EA	3
54	5	PAFZZ	5960-00-134-6004	5749-68A6W	81349	ELECTRON TUBE	EA	5
54	6	PAFZZ		SMD248862-2	80063	FILTER, BANDPASS	EA	1
54	7	PAFZZ		SMD248861-2	80063	FILTER, BANDPASS	EA	1
54	8	PAFZZ		CM15C820G03-2	81349	CAPACITOR, FIXED, MICA	EA	3
54	9	PAFZZ		SMD248863-2	80063	FILTER, BANDPASS	EA	1
54	10	PAFZZ		SMD249234	80063	TRANSFORMER, INTERMEDIATE, FREQ	EA	1
54	11	PAFZZ	591-00-667-6123	SMB283227	80063	CAPACITOR, FIXED, CERAMIC	EA	1
54	12	PAFZZ		CM15C510GN3-2	81349	CAPACITOR, FIXED, MICA	EA	1
54	13	PAFZZ		SMD248860-2	80063	FILTER, BANDPASS	EA	1
54	14	PAFZZ	5910-00-665-0260	SMB283236	80063	CAPACITOR, FIXED, PAPER	EA	1
54	15	PAFZZ		SMC283188	80063	CONNECTOR, RECEPTACLE, ELECTRICA	EA	1

SECTION II REPAIR PARTS LIST

(1) ILLUSTRATION		(2)	(3)	(4)	(5)	(6) DESCRIPTION	(7)	(8)
(a) FIG NO.	(b) ITEM NO.	SMR CODE	NATIONAL STOCK NUMBER	PART NUMBER	FSCM	USABLE ON CODE	U/M	QTY INC IN UNIT
54	16	XBFZZ		SMB283178	80063	JACK, TIP	EA	1
54	17	PAFZZ	5950-00-537-5125	SMD249237	80063	COIL, RADIO FREQUENCY	EA	1
54	18	PAFZZ	5905-00-577-7137	RV2LAXSA101B	81349	RESISTOR, VARIABLE	EA	1
54	19	PAFZZ	5905-00-247-8710	RC32GF220J	81349	RESISTOR, FIXED, COMPOSITION	EA	1
54	20	PAFZZ	5905-00-815-5498	RV2LAXSA103B	81349	RESISTOR, VARIABLE	EA	1
54	21	PAFZZ	5930-00-222-9823	TS103P01	81349	SOCKET, ELECTRON TUBE	EA	1
55	1	PAFZZ	5960-00-188-3551	6AK6	81349	ELECTRON TUBE	EA	1
55	2	PAFZZ	5905-00-523-8388	SMD249239	80063	TRANSFORMER, INTERMEDIATE, FREQ	EA	1
55	3	PAFZZ		SMD249238	80063	TRANSFORMER, INTERMEDIATE, FREQ	EA	2
55	4	PAFZZ	5960-00-262-0210	5814A	81349	ELECTRON TUBE	EA	3
55	5	PAFZZ	5960-00-264-2089	5749-68A6W	81349	ELECTRON TUBE	EA	5
55	6	PAFZZ	5915-00-523-1962	SMD248861	80063	FILTER, BANDPASS	EA	1
55	7	PAFZZ	5910-00-727-4995	CM15C820G03	81349	CAPACITOR, FIXED, MICA	EA	3
55	8	PAFZZ	5910-00-666-7974	SMB283228-2	80063	CAPACITOR, VARIABLE	EA	1
55	9	PAFZZ	5910-00-666-7974	SMB283228-2	80063	CAPACITOR, VARIABLE	EA	1
55	10	PAFZZ		SMD248863	80063	FILTER, BANDPASS	EA	1
55	11	PAFZZ	5910-00-666-7974	SMB283228-2	80063	CAPACITOR, VARIABLE	EA	1
55	12	PAFZZ	5910-00-666-7974	SMB283228-2	80063	CAPACITOR, VARIABLE	EA	1
55	13	PAFZZ		SMD249234	80063	TRANSFORMER, INTERMEDIATE, FREQ	EA	1
55	14	PAFZZ	5910-40-667-6123	SMB283227	80063	CAPACITOR, FIXED, CERAMIC	EA	1
55	15	PAFZZ	5915-00-646-5241	SMD248860	80063	FILTER, BANDPASS	EA	1
55	16	PAFZZ	5910-00-844-9694	CM15C510GN3	81349	CAPACITOR, FIXED, MICA	EA	1
55	17	PAFZZ	5915-00-523-1960	SMD248862	80063	FILTER, BANDPASS	EA	1
55	18	PAFZZ	591040-667-6123	SMB283236	80063	CAPACITOR, FIXED, PAPER	EA	1
55	19	PAFZZ		SMC283188	80063	CONNECTOR, RECEPTACLE, ELECTRICAL	EA	1
55	20	XBFZZ	5935-00-850-2250	SMB283178	80063	JACK, TIP	EA	1
55	21	PAFZZ	5950-00-537-5125	SMD249237	80063	COIL, RADIO FREQUENCY	EA	1
55	22	PAFZZ	5905-00-809-9829	RV2LAXSA101B	81349	RESISTOR, VARIABLE	EA	1
55	23	PAFZZ	5905-00-279-1738	RC32GF220J	81349	RESISTOR, FIXED, COMPOSITION	EA	1
55	24	PAFZZ		RV2LAXSA103B	81349	RESISTOR, VARIABLE	EA	1
55	25	PAFZZ		TS103P01-2	81349	SOCKET, ELECTRON TUBE	EA	1
						GROUP 09030103 RADIO FREQUENCY AMPLIFIER A1A7		
56	1	PAFZZ	5935-00-810-7514	SMB283182	80063	CONNECTOR, RECEPTACLE, ELECTRICAL	EA	2
56	2	PAFZZ	5935-00-903-9778	MS24056-1	96906	CONNECTOR, RECEPTACLE, ELECTRICAL	EA	1
56	3	PAFZZ	5950-00-698-1986	SMD249099	80063	COIL, RADIO, FREQUENCY	EA	3
56	3A	PAFZZ	5950-00-698-0226	SMC249244	80063	CORE, ADJUSTABLE TUNING	EA	3
56	4	PAFZZ		6C4	81349	ELECTRON TUBE	EA	3
56	5	PAFZZ	5950-00-647-8096	SMD249235	80063	TRANSFORMER, RADIO FREQUENCY	EA	1
56	6	PAFZZ	5950-00-510-1744	SMD249098	80063	COIL, RADIO FREQUENCY	EA	3
56	6A	PAFZZ	5950-00-698-0226	SMC249244	80063	CORE, ADJUSTABLE TUNING	EA	3

SECTION II REPAIR PARTS LIST

(1) ILLUSTRATION		(2)	(3)	(4)	(5)	(6)	(7)	(8)
(a) FIG NO.	(b) ITEM NO.	SMR CODE	NATIONAL STOCK NUMBER	PART NUMBER	FSCM	DESCRIPTION USABLE ON CODE	U/M	QTY INC IN UNIT
56	7	XBFZZ	5820-00-838-2704	SMC343632	80063	RACK ASSEMBLY	EA	1
56	8	PAFZZ		SMB249065	80063	OVEN, CRYSTAL	EA	1
56	9	PAFZZ	5960-00-134-6031	5654-6AKSW	81349	ELECTRON TUBE	EA	1
56	10	PAFZZ	5960-00-262-0210	5814A	81349	ELECTRON TUBE	EA	2
56	11	PAFZZ	5950-00-523-B431	SMD249236	80063	TRANSFORMER, RADIO FREQUENCY	EA	1
56	12	XBFZZ		SMD249100	80063	CHASSIS ASSEMBLY	EA	1
56	13	PAFZZ	5950-00-510-1745	SMD249094	80063	COIL, RADIO FREQUENCY	EA	2
56	14	PAFZZ	5950-00-537-5124	SMD249093	80063	COIL, RADIO FREQUENCY	EA	2
56	15	PAFZZ	5950-00-698-1978	SMD249092	80063	COIL, RADIO FREQUENCY	EA	2
56	16	PAFZZ	5950-00-698-1981	SMD249088	80063	TRANSFORMER, RADIO FREQUENCY	EA	1
56	17	PAFZZ	5950-00-510-1746	SMD249087	80063	TRANSFORMER, RADIO FREQUENCY	EA	1
56	18	PAFZZ	5950-00-537-4983	SMD249086	80063	TRANSFORMER, RADIO FREQUENCY	EA	1
56	19	XBFZZ	5820-00-838-2646	SMC343628	80063	RACK ASSEMBLY	EA	3
56	20	XBFZZ	5820-00-252-2777	SMC343630	80063	RACK ASSEMBLY	EA	3
56	21	PDFDD		SMD343629	80063	AMPLIFIER, RADIO FREQUENCY	EA	1
56	22	PAFZZ		SMB283232	80063	CAPACITOR, VARIABLE	EA	1
56	23	PAFZZ	5950-00-523-8432	SMD249091	80063	TRANSFORMER, RADIO FREQUENCY	EA	1
56	24	PAFZZ	5950-00-510-1748	SMD249090	80063	TRANSFORMER, RADIO FREQUENCY	EA	1
56	25	PAFZZ	5950-00-510-1749	SMD2490B9	80063	TRANSFORMER, RADIO FREQUENCY	EA	1
56	26	PAFZZ	5960-00-985-8987	6DC6	81349	ELECTRON TUBE	EA	1
56	27	PAFZZ	5950-00-510-1747	SM249097	80063	COIL, RADIO FREQUENCY	EA	2
56	28	PAFZZ	5950-00-698-1984	SMD249096	80063	COIL, RADIO FREQUENCY	EA	2
56	29	PAFZZ	5950-00-510-1750	SMD249095	80063	COIL, RADIO FREQUENCY	EA	2
56	30	XBFZZ	5820-00-838-2649	SMC343631	80063	RACK ASSEMBLY	EA	1
56	31	PAFZZ		SMB283183	80063	CONNECTOR, PLUG ELECTRICAL	EA	5
56	32	PAFZZ	5935-00-204-6391	SMB283181	80063	CONNECTOR, PLUG ELECTRICAL	EA	5
56	33	PAFZZ	5935-00-204-6403	SMB283180	80063	CONNECTOR, PLUG ELECTRICAL	EA	8
56	34	PAFZZ	5910-00-726-1197	CC20CH040C	81349	CAPACITOR, FIXED CERAMIC	EA	1
56	35	PAFZZ	5910-00-681-7617	CC20CK020C	81349	CAPACITOR, FIXED CERAMIC	EA	5
56	36	PAFZZ	5910-00-088-0756	CC20CKR75C	81349	CAPACITOR, FIXED CERAMIC	EA	1
56	37	PAFZZ	5910-00-993-2380	CM15B120KN3	81349	CAPACITOR, FIXED MICA	EA	3
56	38	PAFZZ		SMC283226-16	80063	CAPACITOR, FIXED MICA	EA	1
56	39	PAFZZ	5910-00-667-6123	SMB283227	80063	CAPACITOR, FIXED CERAMIC	EA	22
56	40	PAFZZ	5910-00-805-6632	CC20CK0R5C	81349	CAPACITOR, FIXED CERAMIC	EA	1
56	41	PAFZZ	5905-00-106-1282	RC20GF223K	81349	RESISTOR, FIXED COMPOSITION	EA	4
56	42	PAFZZ	5906-00-409-7616	RC20GF105K	81349	RESISTOR, FIXED, COMPOSITION	EA	3
56	43	PAHZZ	5935-00-132-2405	TS102P01	81349	SOCKET, ELECTRON TUBE	EA	5
56	44	PAFZZ	5905-00-116-8561	RC20GF270J	81349	RESISTOR, FIXED, COMPOSITION	EA	3
56	45	PAFZZ	5905-00-141-1168	RC20GF222J	81349	RESISTOR, FIXED, COMPOSITION	EA	7
56	46	PAFZZ	5950-00-704-1993	SMC249217	80063	COIL, RADIO FREQUENCY	EA	6

SECTION II REPAIR PARTS LIST

(1) ILLUSTRATION		(2)	(3)	(4)	(5)	(6)	(7)	(8)
(a) FIG NO.	(b) ITEM NO.	SMR CODE	NATIONAL STOCK NUMBER	PART NUMBER	FSCM	DESCRIPTION USABLE ON CODE	U/M	QTY INC IN UNIT
56	47	PAFZZ	5910-00-668-5903	SMB283262	80063	CAPACITOR, FIXED, PAPER	EA	1
56	48	PAFZZ	5905-00-114-5489	RC20GF823K	81349	RESISTOR, FIXED COMPOSITION	EA	1
56	49	PAFZZ	5905-00-141-0591	RC20GF103J	81349	RESISTOR, FIXED, COMPOSITION	EA	3
56	50	PAFZZ	5910-00-850-9074	CN15C330JN3	81349	CAPACITOR, FIXED MICA	EA	1
56	51	PAFZZ		CC20CH010C	81349	CAPACITOR, FIXED CERAMIC	EA	2
56	52	PAFZZ	5905-00-104-8350	RC20GF221J	81349	RESISTOR, FIXED, COMPOSITION	EA	1
56	53	PAHZZ	5905-00-141-1071	RC20GF474K	81349	RESISTOR, FIXED COMPOSITION	EA	1
56	54	PAFZZ	5905-00-116-8558	RC20GF155K	81349	RESISTOR, FIXED COMPOSITION	EA	1
56	55	PAFZZ	5905-00-114-5416	RC20GF274K	81349	RESISTOR, FIXED COMPOSITION	EA	1
56	56	PAFZZ		SMB249228	80063	SWITCH, SECTION ROTARY	EA	5
56	57	PAFZZ	5930-00-204-6407	SMB249229	80063	SWITCH, SECTION ROTARY	EA	1
56	58	PAFZZ		SMB249230	80063	SWITCH, SECTION ROTARY	EA	1
56	59	PAFZZ	5910-00-807-1527	CC20CH080C	81349	CAPACITOR, FIXED CERAMIC	EA	1
56	60	PAFZZ		SMB283243-1	80063	CAPACITOR, FIXED MICA	EA	2
56	61	PAFZZ	5910-00-543-9197	SMB283237	80063	CAPACITOR, FIXED, PAPER	EA	1
56	62	PAFZZ	5905-00-104-8335	RC20GF124K	81349	RESISTOR, FIXED COMPOSITION	EA	1
56	63	PAFZZ		SMC249218	80063	COIL, RADIO FREQUENCY	EA	1
56	64	PAFZZ	5910-00-810-2476	SMC283235	80063	CAPACITOR, VARIABLE	EA	1
56	65	PAFZZ	5910-00-727-3548	CM15C0200J03	81349	CAPACITOR, FIXED MICA	EA	1
56	66	PAFZZ	5950-00-387-0489	SMC178505	80063	CHKE, RADIO FREQUENCY	EA	4
56	67	PAFZZ	5910-00-543-0506	CC20CK1R5C	81349	CAPACITOR, FIXED CERAMIC	EA	2
56	68	PAFZZ	5910-00-850-0540	CM15C510GN3	81349	CAPACITOR, FIXED MICA	EA	2
56	69	PAFZZ	5910-00-932-5724	CM15C680GN3	81349	CAPACITOR, FIXED MICA	EA	1
56	70	PAFZZ	5910-00-835-3513	SMB283238	80063	CAPACITOR, FIXED PAPER	EA	1
56	71	PAFZZ	5930-00-204-6409	SMB249231	80063	SWITCH, SECTION ROTARY	EA	1
56	72	PAFZZ		CM15F101GN3	81349	CAPACITOR, FIXED MICA	EA	2
56	73	PAFZZ	5905-00-114-5441	RC20GF563J	81349	RESISTOR, FIXED COMPOSITION	EA	1
56	74	PAFZZ		CM15F201GN3	81349	CAPACITOR, FIXED MICA	EA	1
56	75	PAFZZ	5905-00-141-0600	RC20GF822K	81349	RESISTOR, FIXED COMPOSITION	EA	1
56	76	PAFZZ	5910-00-270-3196	CM15F221GN3	81349	CAPACITOR, FIXED, MICA	EA	3
56	77	PAFZZ	5935-00-222-9828	TS103P01	81349	SOCKET, ELECTRON TUBE	EA	1
56	78	PAFZZ	5905-00-104-8336	RC20GF104K	81349	RESISTOR, FIXED, COMPOSITION	EA	1
56	79	PAFZZ	5905-00-935-8543	RC20GF330K	81349	RESISTOR, FIXED COMPOSITION	EA	1
56	80	PAFZZ	5905-00-247-8733	RC32GF562K	81349	RESISTOR, FIXED COMPOSITION	EA	1
56	81	PAFZZ	5950-00-053-8245	SMC249216	80063	COIL, RADIO FREQUENCY	EA	1
56	82	PAFZZ	5935-00-222-9828	TS103P01	81349	SOCKET, ELECTRON TUBE	EA	1
56	83	PAFZZ	5905-00-252-1050	RC32GF393K	81349	RESISTOR, FIXED COMPOSITION	EA	1
56	84	PAFZZ		CM15F151GN3	81349	CAPACITOR, FIXED MICA	EA	1
56	85	PAFZZ	5905-00-104-8346	RC20GF334	81349	RESISTOR, FIXED COMPOSITION	EA	1

SECTION II REPAIR PARTS LIST

(1) ILLUSTRATION		(2)	(3)	(4)	(5)	(6) DESCRIPTION	(7)	(8)
(a) FIG NO.	(b) ITEM NO.	SMR CODE	NATIONAL STOCK NUMBER	PART NUMBER	FSCM	USABLE ON CODE	U/M	QTY INC IN UNIT
						GROUP 09030104 OSCILLATOR ASSEMBLY A1A8		
57	1	PAFZZ	5955-00-267-4196	CR36U11500KC	81349	CRYSTAL UNIT QUARTZ	EA	1
57	2	PAFZZ		CR36U1500KC	81349	CRYSTAL UNIT QUARTZ	EA	1
57	3	PAFZZ	5955-00-087-063	CR36U1450000MHZ	81349	CRYSTAL UNIT QUARTZ	EA	1
57	4	PAFZZ	5955-00-984-0820	CR36U9500KC	81349	CRYSTAL UNIT QUARTZ	EA	1
57	5	PAFZZ	5955-00-889-3917	CR36U1000KC	81349	CRYSTAL UNIT QUARTZ	EA	1
57	6	PAFZZ		CR36U12500KC	81349	CRYSTAL UNIT QUARTZ	EA	1
57	7	PAFZZ		CR36U14000KC	81349	CRYSTAL UNIT QUARTZ	EA	1
57	8	PAFZZ	5955-00-951-9029	CR36U9000KC	81349	CRYSTAL UNIT QUARTZ	EA	1
57	9	PAFZZ	5955-00-951-9019	CR36U13000KC	81349	CRYSTAL UNIT QUARTZ	EA	1
57	10	PAFZZ	5955-00-861-9363	CR36U1200KC	81349	CRYSTAL UNIT QUARTZ	EA	1
57	11	PAFZZ	5950-00-523-8431	SMD249236	80063	TRANSFORMER, RADIO FREQUENCY	EA	1
57	12	XBFZZ	5935-00-850-2250	SMB283178	80063	JACK, TIP	EA	1
57	13	PAFZZ	5910-00-668-5206	SMB283231	80063	CAPACITOR, VARIABLE	EA	2
57	14	PAFZZ		SMB283232	80063	CAPACITOR, VARIABLE	EA	2
57	15	PAFZZ	5910-00-668-5204	SMB283233	80063	CAPACITOR, VARIABLE	EA	2
57	16	XBFZZ		SMC249043	80063	CHASSIS ASSEMBLY	EA	1
57	17	PAFZZ	5820-00-511-4258	SMD249007	80063	OSCILLATOR ASSEMBLY	EA	1
57	18	PAFZZ	5935-00-636-5913	SMB283198	80063	CONNECTOR, RECEPTACLE	EA	1
57	19	PAFZZ	5960-00-134-6031	5654-6AK5W	81349	ELECTRON TUBE	EA	1
57	20	PAFZZ	5955-00-892-3604	CR36U15000KC	81349	CRYSTAL UNIT QUARTZ	EA	1
57	21	PAFZZ	5955-00-813-7545	CR36U16000KC	81349	CRYSTAL UNIT QUARTZ	EA	1
57	22	PAFZZ	5955-00-892-3603	CR36U11000KC	81349	CRYSTAL UNIT QUARTZ	EA	1
57	23	PAFZZ		CR36U17000KC	81349	CRYSTAL UNIT QUARTZ	EA	1
57	24	PAFZZ	5955-00-694-1090	SMB249038	80063	BOARD ASSEMBLY	EA	1
57	25	PAHZZ	5935-00-201-7922	SMB283184	80063	PLUG, TIP	EA	1
57	26	PAFZZ		CR36U10500KC	81349	CRYSTAL UNIT QUARTZ	EA	1
57	27	XBFZZ		SMC178599	80063	SWITCH, SECTION	EA	1
57	28	PAFZZ	5910-00-850-9074	CM15C330JN3	81349	CAPACITOR, FIXED, MICA	EA	1
T57	29	PAFZZ	5910-00-892-9904	CM15C390JN3	81349	CAPACITOR, FIXED, MICA	EA	1
57	30	PAFZZ	5910-00-850-0541	CM15C470JN3	81349	CAPACITOR, FIXED, MICA	EA	1
57	31	PAFZZ	5910-00-932-2738	CM15C820GN3	81349	CAPACITOR, FIXED, MICA	EA	1
57	32	PAFZZ		CM15F101GN3	81349	CAPACITOR, FIXED, MICA	EA	1
57	33	PAFZZ		CM15F121GN3	81349	CAPACITOR, FIXED, MICA	EA	1
57	34	PAFZZ	5910-00-667-6123	SMB283227	80063	CAPACITOR, FIXED, CERAMIC	EA	7
57	35	PAFZZ		CM15F151GN3	81349	CAPACITOR, FIXED, MICA	EA	1
57	36	PAHZZ	5935-00-132-2405	TS102P01	81349	SOCKET, ELECTRON TUBE	EA	1
57	37	PAFZZ	5910-00-681-7615	CC20UJ120J	81349	CAPACITOR, FIXED, CERAMIC	EA	1
57	38	PAFZZ	5910-00-726-1197	CC20CH0400C	81349	CAPACITOR, FIXED, CERAMIC	EA	2
57	39	PAFZZ		SMC283226-16	80063	CAPACITOR, FIXED, MICA	EA	2
57	40	PAFZZ	5955-00-518-4601	SMC249045	80063	OVEN ASSEMBLY	EA	1

SECTION II REPAIR PARTS LIST

(1) ILLUSTRATION		(2)	(3)	(4)	(5)	(6)	(7)	(8)
(a) FIG NO.	(b) ITEM NO.	SMR CODE	NATIONAL STOCK NUMBER	PART NUMBER	FSCM	DESCRIPTION USABLE ON CODE	U/M	QTY INC IN UNIT
57	41	PAFZZ	5905-00-104-8330	RC20GF333K	81349	RESISTOR, FIXED, COMPOSITION	EA	1
57	42	PAFZZ	5950-00-704-1993	SMC249217	80063	COIL, RADIO FREQUENCY	EA	
57	43	PAFZZ	5905-00-104-8335	RC20GF124K	81349	RESISTOR, FIXED, COMPOSITION	EA	1
57	44	PAFZZ	5905-00-110-0310	RC20GF392K	81349	RESISTOR, FIXED, COMPOSITION	EA	2
57	45	PAFZZ	5910-00-901-8796	CM15C560GN3	81349	CAPACITOR, FIXED, MICA	EA	1
57	46	PAFZZ	5910-00-932-5724	CM15C680GN3	81349	CAPACITOR, FIXED, MICA	EA	1
57	47	PAFZZ	5910-00-993-2380	CM15B120KN3	81349	CAPACITOR, FIXED, MICA	EA	1
57	48	PAFZZ		CM15B108KN3	81349	CAPACITOR, FIXED, MICA	EA	1
						GROUP 09030105 GEAR ASSEMBLY A1A9		
58	1	XBFZZ	3040-00-396-3116	SMB178414	80063	COUPLING, SHAFT	EA	10
58	3	XBFZZ		SMB396981	80063	COUPLING, SHAFT	EA	1
58	4	XBFZZ	5940-00-542-9890	SMB178486	80063	COUPLING, SHAFT	EA	6
58	5	XBFZZ		SMB178491	80063	INSULATOR, BUSHING	EA	2
58	6	XBFZZ	5820-00-784-9315	SMB343586	80063	COUPLING, SHAFT	EA	3
58	7	XBFZZ	3020-00-640-4824	SMC178700	80063	GEAR, BEVEL	EA	2
58	8	XBFZZ		SMD343600-7	80063	NUT, PLAIN, SQUARE	EA	5
58	9	XBFZZ	3020-00-640-4758	SMB178702	80063	GEAR, SPUR	EA	1
58	10	XBFZZ		SMB178707	80063	GEAR, BEVEL	EA	2
58	11	XBFZZ	3020-00-697-7770	SMB178752	80063	GEAR, SPUR	EA	1
58	12	XBFZZ	5360-00-664-2197	SMB178785	80063	SPRING, HELICAL EXTENSION	EA	6
58	13	XBFZZ	5820-00-657-4708	SNC178828	80063	SPRING, BRACKET	EA	1
58	14	XBFZZ		SMB178829	80063	SPRING, HELICAL EXTENSION	EA	
58	15	XBFZZ		SMB178830	80063	SCREW, MACHINE	EA	1
58	16	PAFZZ	3020-00-938-7552	SMC343591	80063	GEAR ASSEMBLY	EA	1
58	17	XBFZZ		SMB178901	80063	SHAFT, DRIVE	EA	1
58	18	XBFZZ		SMB178906	80063	SPACER, SLEEVE	EA	4
58	19	XBFZZ		SMB178907	80063	SPACER, SLEEVE	EA	2
58	20	XBFZZ	3020-00-671-5826	SMB178912	80063	GEAR, SPUR	EA	3
58	21	XBFZZ		SMB396982	80063	GEAR, SPUR	EA	1
58	22	XBFZZ		SMB396983	80063	GEAR, SPUR	EA	1
58	23	XBFZZ		SMB396983	80063	GEAR, SPUR	EA	1
58	24	XBFZZ	3020-00-942-7802	SMB178935	80063	GEAR, SPUR	EA	1
58	25	XBFZZ		SMB178957	80063	GEAR, SPUR	EA	3
58	26	XBFZZ		SMB178977	80063	GEAR, SPUR	EA	1
58	27	XBFZZ	3020-00-683-9483	SMC179063	80063	GEAR, SPUR	EA	1
58	28	XBFZZ		SMB396985	80063	GEAR, SPUR	EA	1
58	29	XBFZZ		MS35200-25	96906	SCREW, MACHINE	EA	1
58	30	XBFZZ		SMB248865	80063	SHAFT, EXTENSION	EA	1
58	31	XBFZZ		SMB248877	80063	BUSHING, SLEEVE	EA	1
58	32	XBFZZ		SMB248879	80063	SPACER, SLEEVE	EA	6
58	33	XBFZZ		SMB248880	80063	SPACER, SLEEVE	EA	2
58	34	XBFZZ		SMB248884	80063	GEAR, SPUR	EA	2
58	35	XBFZZ		SMB248885	80063	SHAFT, DRIVE	EA	2
58	36	XBFZZ		SMB248888	80063	SPACER, SLEEVE	EA	

REPAIR PARTS LIST

SECTION II REPAIR PARTS LIST

(1) ILLUSTRATION		(2)	(3)	(4)	(5)	(6)	(7)	(8)
(a) FIG NO.	(b) ITEM NO.	SMR CODE	NATIONAL STOCK NUMBER	PART NUMBER	FSCM	DESCRIPTION USABLE ON CODE	U/M	QTY INC IN UNIT
58	37	XBFZZ		SMB248895	80063	HUB, DIAL	EA	1
58	38	XBFZZ		SMB248896	80063	GEAR, SPUR	EA	1
58	39	XBFZZ		SMB248900	80063	SPACER, SLEEVE	EA	1
58	40	XBFZZ	5820-00-618-6632	SMB248902	80063	GEAR, SPUR	EA	1
58	41	XBFZZ	3020-00-810-9465	SMB248907	80063	GEAR, SPUR	EA	1
58	42	XBFZZ	3020-00-942-7804	SMB248914	80063	GEAR, SPUR	EA	1
58	43	XBFZZ		SMB248924	80063	SPACER, SLEEVE	EA	4
58	44	XBFZZ		SMB248934	80063	COUPLING, SHAFT	EA	2
58	45	XBFZZ		SMB396986	80063	COUPLING, SHAFT	EA	1
58	46	XBFZZ	5820-00-671-2936	SMB248938	80063	GEAR, SPUR	EA	1
58	47	XBFZZ	3020-00-671-8535	SMB248939	80063	GEAR, SPUR	EA	1
58	48	XBFZZ		SMB248941	80063	POST, GEAR	EA	1
58	49	XBFZZ		SMB248942	80063	GEAR, SPUR	EA	1
58	50	XBFZZ	5820-00-856-3411	SMB248943	80063	GEAR, SPUR	EA	1
58	51	XBFZZ	3020-00-671-5832	SMB248944	80063	GEAR, SPUR	EA	1
58	52	XBFZZ		SMB248945	80063	GEAR, SPUR	EA	1
58	53	XBFZZ		SMB343594	80063	PLATE, MOUNTING	EA	1
58	54	XBFZZ		SMB398987	80063	GEAR, SPUR	EA	1
58	55	XBFZZ	3020-00-679-9889	SMB248952	80063	GEAR, SPUR	EA	1
58	56	XBFZZ	3040-00-942-4954	SMB248955	80063	SHAFT ASSEMBLY	EA	1
58	57	XBFZZ	3040-00-942-4955	SMB248956	80063	SHAFT ASSEMBLY	EA	1
58	58	XBFZZ		SMB248957	80063	SHAFT ASSEMBLY	EA	1
58	59	XBFZZ	3040-00-942-4957	SMB248958	80063	SHAFT ASSEMBLY	EA	2
58	60	XBFZZ	5820-00-784-5411	SMC248959	80063	SHAFT ASSEMBLY	EA	1
58	61	XBFZZ		SMC343597	80063	STOP ASSEMBLY	EA	1
58	62	XBFZZ	5820-00-671-5837	SMC343598	80063	STOP ASSEMBLY	EA	1
58	63	XBFZZ		SMC248962	80063	TRIMMER ASSEMBLY	EA	1
58	64	XBFZZ		SMC248966	80063	PLATE, MOUNTING	EA	1
58	65	XBFZZ	5820-00-327-4725	SMC248967	80063	GEAR, SPUR	EA	1
58	66	XBFZZ		SMC248968	80063	PLATE, LOCKING	EA	1
58	67	XBFZZ		SMC396988	80062	PLATE, LOCKING	EA	1
58	68	XBFZZ		SMC248977	80063	PLATE, REAR	EA	1
58	69	XBFZZ		SMC343601	80063	PLATE, MOUNTING	EA	1
58	70	XBFZZ		SMD343612	80063	PLATE, FRONT	EA	1
58	71	XBFZZ	3020-00-925-0075	SMB248932	80063	GEAR, SPUR	EA	1
58	72	XBFZZ		SMB396989	80062	GEAR, SPUR	EA	1
58	73	XBFZZ		SMB249186	80063	SHAFT	EA	2
58	74	XBFZZ	6680-00-752-8255	SMC249195	80063	COUNTER, ROTATE FIXED MOUNTING	EA	1
58	75	XBFZZ		SMB283169	80063	SETSCREW	EA	6
58	76	XBFZZ	5365-00-282-0782	SMB283171-1	80063	RING, RETAINING	EA	1
58	77	XBFZZ		SMB283171-2	80063	RING, RETAINING	EA	1
58	78	XBFZZ		SMD343600-10	80063	SCREW, MACHINE	EA	3
58	79	XBFZZ	5365-00-816-4239	MS16633-1012	96906	RING, RETAINING	EA	6
58	80	XBFZZ	5365-00-200-6707	MS16633-18	96906	RING, RETAINING	EA	1

SECTION II REPAIR PARTS LIST

(1) ILLUSTRATION		(2)	(3)	(4)	(5)	(6) DESCRIPTION	(7)	(8)
(a) FIG NO.	(b) ITEM NO.	SMR CODE	NATIONAL STOCK NUMBER	PART NUMBER	FSCM	USABLE ON CODE	U/M	QTY INC IN UNIT
58	81	XBFZZ		MS16633-1025	96906	RING, RETAINING	EA	2
58	82	XBFZZ		SMB396990	80063	WASHER, FLAT	EA	1
58	83	XBFZZ		SMD343600-2	80063	WASHER, FLAT	EA	1
58	84	XBFZZ		SMD343600-3	80063	WASHER, LOCK	EA	1
58	85	XBFZZ	5305-00-616-1137	SMD343600-4	80063	SCREW, MACHINE	EA	4
58	86	XBFZZ		SMD343600-5	80063	SCREW, MACHINE	EA	4
58	87	XBFZZ		SMD343600-6	80063	SCREW, MACHINE	EA	7
58	88	XBFZZ		SMD343600-7	80063	NUT, PLAIN, SQUARE	EA	8
58	89	XBFZZ		SMB396991	80063	SCREW, MACHINE	EA	1
58	90	XBFZZ		SMB396992	80063	SCREW, MACHINE	EA	1
58	91	XBFZZ		SMB396993	80063	SCREW, MACHINE	EA	1
58	92	XBFZZ		MS35200-25	96906	SCREW, MACHINE	EA	5
58	93	XBFZZ	5305-00-765-4252	MS35200-39	96906	SCREW, MACHINE	EA	5
56	94	XBFZZ		MS396994	80063	SCREW, MACHINE	EA	1
58	95	XBFZZ	5305-00-054-5648	MS35216-13	96906	SCREW, MACHINE	EA	7
58	96	XBFZZ	5305-00-054-6650	MS35216-23	96906	SCREW, MACHINE	EA	3
58	98	XBFZZ		SMB396995	80063	SCREW, MACHINE	EA	1
58	99	XBFZZ	5305-00-054-6652	MS35216-25	96906	SCREW, MACHINE	EA	13
58	100	XBFZZ	5305-00-054-6653	MS35216-26	96906	SCREW, MACHINE	EA	3
58	101	XBFZZ	5305-00-054-6608	MS35216-40	96906	SCREW, MACHINE	EA	7
58	102	XBFZZ	5310-00-929-6395	MS35338-79	96906	WASHER, SPLIT	EA	14
58	103	XBFZZ	5310-00-543-2410	MS35338-21	96906	WASHER, SPLIT	EA	22
58	104	XBFZZ	5310-00-933 8119	MS35338-80	96906	WASHER, SPLIT	EA	9
58	105	XBFZZ		SMB396996	80063	CAM, CONTROL	EA	1
58	106	XBFZZ		SMB396997	80063	CAM, CONTROL	EA	1
58	107	XBFZZ		SMB396998	80063	CAM, CONTROL	EA	1
58	108	XBFZZ		SMB396999	80063	CAM, CONTROL	EA	1
58	109	XBFZZ		SMB397000	80063	CAM, CONTROL	EA	1
58	110	XBFZZ		SMB397001	80063	CAM, CONTROL	EA	1
58	111	XBFZZ		SMB397002	80063	CAM, CONTROL	EA	1
58	112	XBFZZ		SMB397003	80063	CAM, CONTROL	EA	1
58	113	XBFZZ		SMB397004	80063	CAM, CONTROL	EA	1
58	114	XBFZZ		SMB397005	80063	CAM, CONTROL	EA	1
58	115	XBFZZ		SMC348923	80063	CAM, CONTROL	EA	1
58	116	XBFZZ		SMB248954	80063	CAM, CONTROL	EA	1
58	117	XBFZZ		SMC248971	80063	CAM, CONTROL	EA	1
58	118	XBFZZ	5315-00-823-8744	MS171466	96906	PIN, STRAIGHT HEADLESS	EA	18
58	119	XBFZZ		SMB397006	80063	GEAR, SPUR	EA	1
58	120	XBFZZ		SMB249146	80063	GEAR, SPUR	EA	1
58	121	XBFZZ		SMB248921	80063	SHAFT, DRIVE	EA	1
58	122	XBFZZ		SMC248971	80063	CAM, CONTROL	EA	1

REPAIR PARTS LIST

(1) ILLUSTRATION		(2)	(3)	(4)	(5)	(6) DESCRIPTION	(7)	(8)
(a) FIG NO.	(b) ITEM NO.	SMR CODE	NATIONAL STOCK NUMBER	PART NUMBER	FSCM	USABLE ON CODE	U/M	QTY INC IN UNIT
58	123	XBFZZ		SMC248972	80063	CAP CONTROL	EA	4
58	124	XBFZZ		SMB248920	80063	SHAFT DRIVE	EA	2
58	125	XBFZZ		SMC248971	80063	CAM CONTROL	EA	1
58	126	XBFZZ		SMC248972	80063	CAM CONTROL	EA	3
58	127	PAFZZ	5910-00-850-2234	SMB283234	80063	CAPACITOR VARIABLE	EA	1
58	128	XBFZZ		SMB24883	80063	GEAR, SPUR	EA	1
58	129	XBFZZ	5315-00-460-5793	MS171434	96906	PIN STRAIGHT HEADLESS	EA	1
58	130	XBFZZ		SMB248963	80063	SHIELD, CAPACITOR	EA	1
58	131	XBFZZ		SMB179050	80063	WASHER, NONMETALLIC	EA	3
58	132	XBFZZ		SMB178483-1	80063	WASHER, FLAT	EA	3
58	133	XBFZZ		SMB178739	80063	ROLLER SHAFT	EA	5
58	134	XBFZZ		SMB178913	80063	GEAR, SPUR	EA	1
58	135	XBFZZ		SMC178855	80063	GEAR, SPUR	EA	3
58	136	XBFZZ		SMB178861	80063	GEAR SPUR	EA	1
58	137	XBFZZ		SMC343590	80063	GEAR, SPUR	EA	1

REPAIR PARTS LIST

(1) ILLUSTRATION		(2)	(3)	(4)	(5)	(6) DESCRIPTION	(7)	(8)
(a) FIG NO.	(b) ITEM NO.	SMR CODE	NATIONAL STOCK NUMBER	PART NUMBER	FSCM	USABLE ON CODE	U/M	QTY INC IN UNIT
						GROUP 09030106 POWER SUPPLY A1A5		
59		PAFHD	6130-00-689-5268	SMD248984	80063	POWER SUPPLY A1A5	EA	1
59	1	PAFZZ	5950-00-510-1672	SMC248798	80063	TRANSFORMER, POWER SUPPLY	EA	1
59	2	PAFZZ	5960-00-262-0221	26Z5W	81349	ELECTRON TUBE	EA	2
59	3	PAFZZ		SMC283191	80063	CONNECTOR, RECEPTACLE, ELECTRICAL	EA	1
59	4	PAFZZ	5935-00-222-9828	TS103P01	81349	SOCKET, ELECTRON TUBE	EA	2
59	5	XBFZZ		SMB283187	80063	TERMINAL BOARD	EA	1
						GROUP 09030107 RADIO FREQUENCY OSCILLATOR A1A6		
60	1	PAFZZ	5935-00-903-9778	MS24056-1	96906	CONNECTOR, RECEPTACLE, ELECTRICAL	EA	1
60	2	XBFZZ		RG187U	81349	CABLE, RADIO FREQUENCY	EA	1
60	3	PAFZZ	5820-00-327-4393	SMD343626	80063	OSCILLATOR, RADIO FREQUENCY	EA	1
60	4	XBFZZ	5960-00-577-6135	SMB114043	80063	SHIELD, OSCILLATOR	EA	1
60	5	PAFZZ	5905-00-106-9348	RC20GF154J	81349	RESISTOR, FIXED, COMPOSITION	EA	1
60	6	PAFZZ		SMB28313	80063	CONNECTOR, PLUG, ELECTRICAL	EA	1
60	7	PAHZZ	5935-00-132-2405	TS102P01	81349	SOCKET, ELECTRON TUBE	EA	1
60	8	PAFZZ	5905-00-114-5441	RC20GF563J	81349	RESISTOR, FIXED, COMPOSITION	EA	1
60	9	PAHZZ	5905-00-111-8372	RC32GF222J	81349	RESISTOR, FIXED, COMPOSITION	EA	1
60	10	PAFZZ	5910-00-667-6123	SMB283227	80063	CAPACITOR, FIXED PAPER DIELECT	EA	1
						GROUP 09030108 FRONT PANEL ASSEMBLY A1A34		
61	1	PAFZZ	5935-00-259-3318	SMC283192	80063	CONNECTOR, PLUG, ELECTRICAL	EA	1
61	2	XBFZZ	5940-00-983-6129	41TB8	81349	TERMINAL BOARD	EA	2
61	3	PAFZZ	5910-00-667-6123	SMB283227	80063	CAPACITOR, FIXED, CERAMIC	EA	1
61	4	PAFZZ	5905-00-116-8569	SMC283189	80063	CONNECTOR, PLUG, ELECTRICAL	EA	1
61	5	PAFZZ		SMB283200	80063	CONNECTOR, PLUG, ELECTRICAL	EA	1
61	6	PAFZZ		SMB283195	80063	CONNECTOR, PLUG, ELECTRICAL	EA	2
61	7	PAFZZ	5905-00-603-5855	SMC283204-1	80063	RESISTOR, VARIABLE	EA	1
61	8	PAFZZ		SMB249225	80063	FUSEHOLDER	EA	2
61	9	PAFZZ	5935-00-754-8787	MS24055-1	96906	CONNECTOR, PLUG, ELECTRICAL	EA	2
61	10	PAFZZ		SMB249221	80063	FILTER, RADIO INTERFACE	EA	1
61	11	PAFZZ	5910-00-165-2751	CE64C500G	81349	CAPACITOR, FIXED, ELECTROLYTIC	EA	1
61	12	PAFZZ	5905-00-116-8569	RC20GF821K	81349	RESISTOR, FIXED, COMPOSITION	EA	1
61	13	PAFZZ	5905-00-141-1165	RC20GF682K	81349	RESISTOR, FIXED, COMPOSITION	EA	1
61	14	PAFZZ	5961-00-853-2607	1N933	81349	SEMICONDUCTOR DEVIC, DIODE	EA	1
61	15	PAFZZ		SMC283204-2	80063	RESISTOR, VARIABLE	EA	1
61	16	PAFZZ	6130-00-548-0067	SMC283177	80063	RECTIFIER, METALLIC	EA	1
61	17	PAFZZ	6625-00-669-0769	SMC283217	80063	VOLTMETER	EA	1
61	18	PAFZZ	5910-00-806-9158	SMC283240	80063	CAPACITOR, FIXED, PAPER	EA	1
61	19	PAFZZ	5905-00-284-3200	SMC283203	80063	RESISTOR, VARIABLE	EA	1
61	20	PAFZZ		RC20GF562K	81349	RESISTOR, FIXED, COMPOSITION	EA	1
61	21	PAFZZ	5905-00-114-5441	RC20GF563J	81349	RESISTOR, FIXED, COMPOSITION	EA	1

REPAIR PARTS LIST

REPAIR PARTS LIST

(1) ILLUSTRATION		(2)	(3)	(4)	(5)	(6)	(7)	(8)
(a) FIG NO.	(b) ITEM NO.	SMR CODE	NATIONAL STOCK NUMBER	PART NUMBER	FSCM	DESCRIPTION USABLE ON CODE	U/M	QTY INC IN UNIT
61	22	PAFZZ	5930-00-204-6393	SMC249223	80063	SWITCH, ROTARY	EA	1
61	23	PAFZZ	5930-00-548-8570	SMA179028	80063	SWITCH, ROTARY	EA	1
61	24	PAFZZ	5930-00-583-5258	SMB179030	80063	SWITCH, ROTARY	EA	1
61	25	PAFZZ	5905-00-485-4564	RC32GF2R7K	81349	RESISTOR, FIXED, COMPOSITION	EA	1
61	26	PAFZZ	5905-00-506-6446	RN6503571F	81349	RESISTOR, FIXED, FILM	EA	1
61	27	PAFZZ	5905-00-342-3382	RN6502000F	81349	RESISTOR, FIXED, FILM	EA	4
61	28	PAFZZ		SMB283221-1	80063	RESISTOR, FIXED, FILM	EA	1
61	29	PAFZZ	5905-00-348-2454	RN65D3921F	81349	RESISTOR, FIXED, FILM	EA	1
61	30	PAFZZ	5905-00-189-2493	RN6502741F	81349	RESISTOR, FIXED, FILM	EA	1
61	31	PAFZZ	5905-00-428-5039	SMB283221-2	80063	RESISTOR, FIXED, FILM	EA	2
61	32	PAFZZ		SMB283221-4	80063	RESISTOR, FIXED, FILM	EA	1
61	33	PAFZZ		SMB283221-3	80063	RESISTOR, FIXED, FILM	EA	2
61	34	PAFZZ		SMC249112	80063	TERMINAL BOARD	EA	1
61	35	PAFZZ		SMC249222	80063	SWITCH, ROTARY	EA	1
61	36	PAFZZ	5930-00-034-1747	SMA179024	80063	SWITCH, ROTARY	EA	1
61	37	PAFZZ		SMC283216	80063	AMMETER	EA	1
61	38	XBFZZ		SMD249134	80063	PANEL ASSEMBLY, FRONT	EA	1
61	39	XBFZZ	5935-00-683-2746	JJ034	81349	JACK, TELEPHONE	EA	1
61	40	XBFZZ	SMD343623	80063		PANEL ASSEMBLY GROUP 09030109 PANEL ASSEMBLY A1A37	EA	1
62	1	PAFZZ		DKCR76-1	94375	RELAY, ARMATURE	EA	1
62	1A	PAFZZ	5985-00-034-5268	SMC283206	80063	RELAY, ARMATURE	EA	1
62	2	PAFZZ		NE45	81349	LAMP, NEON	EA	1
62	3	PAFZZ	5905-00-114-5393	RC20GF224J	81349	RESISTOR, FIXED COMPOSITION	EA	1
63	1	XBFZZ		CA1725	82679	CABLE ASSY, HFO	EA	1
63	2	XBFZZ		CA480-174-17	82679	CABLE ASSY, RF	EA	1
63	3	PBFDD		AX745	82679	ADPTR ASSY, 17MHZ	EA	7
63	4	XBFZZ		CA480-174-17	82679	CABLE ASSY, RF	EA	1
63	5	PAFZZ		SA143	07999	ADAPT., RF, T	EA	2
63	6	XBFZZ		CA1725	82679	CABLE ASSY, HFO	EA	1
63	7	XBFZZ		TE115-2	82679	TERM., TURRET	EA	1
63	8	PAFZZ		CM111F331J5S	81349	CAP FXD, COMP	EA	1
63	9	PAFZZ	5905-00-686-3129	RC077GF104J	81349	RES. FXD, COMP	EA	1
63	10	PAFZZ	5961-00-024-4304	PC135	84411	CAP, VOLT VAR	EA	1
63	11	PAFZZ		CM111F330J5S	81349	CAP, FXD, MICA	EA	1
63	12	PAFZZ	5905-00-686-9993	RC07GF124J	81349	RES, FXD, COMP	EA	1
63	13	XBFZZ		1E115-2	92825	TERM. TURRET	EA	1
63	14	PAFZZ	5905-00-810-2779	RC07GF275J	81349	RES, FXD, COMP	EA	1
63	15	PAFZZ		CA480-174-17	82679	CABLE ASSY, RF	EA	1

REPAIR PARTS LIST

(1) ILLUSTRATION		(2)	(3)	(4)	(5)	(6) DESCRIPTION	(7)	(8)
(a) FIG NO.	(b) ITEM NO.	SMR CODE	NATIONAL STOCK NUMBER	PART NUMBER	FSCM	USABLE ON CODE	U/M	QTY INC IN UNIT
63	16	PAFZZ		CM111F511G5S	81349	CAP, FXD, MICA	EA	1
63	17	PAPZZ		SMC283191	80063	CONNECTOR, RECEPTACLE, ELECTRICAL	EA	2
63	18	XBFZZ		AX746	82679	TUNING, ASSY, 17MHZ	EA	1
63	19	PAFZZ		JJ171-2	74868	CONN, RECP, RF	EA	1
63	20	XBFZZ		A4948	82679	PC BOARD ASSY	EA	1
63	21	PAFZZ	5055-01-459-4273	CR119-17RO	13075	CRYSTAL, 17MHZ	EA	1
63	22	PAFZZ	5905-00-725-6995	RC07GF271J	81349	RES, FXD, CARBON	EA	1
63	23	PAFZZ		5835000Y5U00203Z	18796	CAP, FXD, CERAMIC	EA	2
63	24	PAFZZ		8131M103X5V01042	18796	CAP, FXD, CERAMIC	EA	1
63	25	PAFZZ	5905-00-135-3973	RC07GF221J	81349	RFS, FXD, CARBON	EA	1
63	26	PAFZZ		WEE12UH	83125	COIL, RF, FXD, 12UH	EA	1
63	27	PAFZZ		1N759A	81350	SCOND, DEV, DIO	EA	1
63	28	PAFZZ	5905-00-473-5251	RC32GF102J	81349	RES, FXD, CARBON	EA	1
63	29	XBFZZ		9541880632-4	06540	STANDOFF, RIVET	EA	2
63	30	XAFZZ		PC674	82679	PCB	EA	1
63	31	PAFZZ	5950-01-035-9331	TT307-16	82679	XMFR, VAR	EA	2
63	32	PAFZZ	5956-01-035-7457	CR119-19R0	13075	CRYSTAL, 19MHZ	EA	1
63	33	PAFZZ		CM111E111J1S	81349	CAP, FXD, MICA	EA	2
63	34	PAFZZ	5905-00-802-6730	RC07GF470J	81349	RES, FXD, CARBON	EA	2
63	35	PAFZZ		CM111F431G5S	81349	CAP, FXD, MICA	EA	1
63	36	PAFZZ		2N2368	81350	TRANSISTOR NPN	EA	1
03	37	PAFZZ	5905-00-688-3738	RC07GF182J	81349	RES, FXD, CARBON	EA	1
63	38	PAFZZ	5905-00-106-3666	RC07GF103J	81349	RFS, FXD, CARBON	EA	1
						GROUP 0904 COMPENSATOR, FREQUENCY CN-1448/TSC-25		
64	1	XBFZZ		MS6399	8267	COVER	EA	2
						GROUP 090401 MAIN CHASSIS ASSEMBLY		
65	1	XBFZZ		600AY6	75382	TERMINAL, BOARD	EA	1
65	2	PAFZZ	5935-00-835-0510	UG625U	80058	CONNECTOR, RECEPTACLE, ELEC	EA	8
65	3	PAFZZ	5935-00-636-5918	MS3102A1655P	96906	CONNECTOR, RECEPTACLE, ELEC	EA	1
65	4	PAFZZ		MDA960-3	01295	SEMICONDUCTOR DEVICE, DIODE	EA	3
65	5	PAFZZ		UGH7805	33888	VOLTAGE REGULATOR	EA	2
65	6	XBFZZ		MS6396-2	82679	PANEL, RIGHT SIDE	EA	1
65	7	PAFZZ		UGH7812	33888	VOLTAGE REGULATOR	EA	1
65	8	PAFZZ	5905-00-104-8336	RC20GF104J	81349	RESISTOR, FIXED, COMPOSITION	EA	1
65	9	PAFZZ	6240-00-892-4420	NE2D	85599	LAMP, NEON	EA	1
65	10	PAFZZ		TS154-4	82679	LAMP, INDICATOR, SUB-MINATURE	EA	1
65	11	PAFZZ	6240-00-851-4352	330	85599	LAMP, INCANDESCENT	EA	1
65	12	PAFZZ		TS153-9	82679	LAMP, INDICATOR, SUB-MINATURE	EA	1
65	13	PAFZZ	6625-00-456-3113	9-0163-009	81030	METER, PHASE COMPARATOR	EA	1

REPAIR PARTS LIST

REPAIR PARTS LIST

(1) ILLUSTRATION		(2)	(3)	(4)	(5)	(6) DESCRIPTION	(7)	(8)
(a) FIG NO.	(b) ITEM NO.	SMR CODE	NATIONAL STOCK NUMBER	PART NUMBER	FSCM	USABLE ON CODE	U/M	QTY INC IN UNIT
65	14	XBFZZ		MS6396-1	82679	PANEL, LEFT SIDE.....	EA	1
65	15	PAFZZ		10F50-0HM	12697	RESISTOR, FIXED, WIRE WOUND	EA	1
65	16	PAFZZ		FU102-1	82679	FUSE, CARTRIDGE	EA	2
65	17	PAHZZ	5920-00-892-9311	HKP	71400	FUSEHOLDER	EA	2
65	18	XBFZZ		LD2523MS6397	82679	PANEL, REAR.....	EA	1
65	19	XBFZZ		BMA510	82679	PANEL ASSEMBLY, REAR.....	EA	1
65	20	PAFDD	5920-01-020-2206	NF116-3	82679	OSCILLATOR, OVENIZED.....	EA	1
65	21	XBFZZ		BMA509	82679	PANEL ASSEMBLY, FRONT	EA	1
65	22	PAFZZ		2BL63	76385	SWITCH, TOGGLE	EA	2
65	23	PAFZZ	5950-00-462-7386	TF372	82679	TRANSFORMER, POWER	EA	1
65	24	PAFZZ		10F10-0HM	12697	RESISTOR, FIXED, WIRE WOUND	EA	2
65	25	XDFFF		A4947	82679	CIRCUIT CD, OSC REL CONT	EA	1
65	26	PAFZZ		5-67261-510	76854	SWITCH, PROGRAMMER.....	EA	1
65	27	XBFZZ		L02522MS6398	82679	PANEL, FRONT	EA	1
65	28	PAFZZ		12986B	81349	SEMICONDUCTOR DEVICE, DIODE	EA	1
65	29	PAFZZ		36D223G015AC2A	56289	CAPACITOR.FIXED, ELECTROLYTIC	EA	1
65	30	PAFZZ	5961-00-199-6008	2N3055	81349	TRANSISTOR.....	EA	1
65	31	XBFZZ		CA1732	82679	WIRING HARNESS, BRANCHED.....	EA	1
65	32	XBFZZ		CA1733	82679	WIRING HARNESS, BRANCHED.....	EA	1
65	33	XBFZZ		CA1734	82679	WIRING HARNESS, BRANCHED.....	EA	1
65	34	XBFZZ		X14578	71279	TERMINAL, STUD.....	EA	6
65	35	XBFZZ		1N100	81349	SEMICONDUCTOR DEVICE, DIODE	EA	4
65	36	PAFZZ	5905-00-141-1168	RC20GF222J	81349	RESISTOR, FIXED, COMPOSITION.....	EA	1
65	37	XDBZZ		PC673	82679	PRINTED WIRING BOARD.....	EA	1
65	38	XBFZZ		2N1711	81349	TRANSISTOR.....	EA	1
						GROUP 090402 CIRCUIT CARD DIVIDER Z104		
66	1	PAHZZ	5905-00-110-7620	RC07GF102J	81349	RESISTOR, FIXED, COMPOSITION.....	EA	3
66	2	PAHZZ	5961-00-022-5664	1N914	81349	SEMICONDUCTOR DEVICE, DIODE	EA	6
66	3	PAHZZ		2N2368	81349	TRANSISTOR.....	EA	3
66	4	PAHZZ	5962-00-566-0973	MC4016P	04713	NETWORK, PROGRAMMABLE MODULO-N .	EA	5
66	5	PAHZZ		0805024X5V00103M	18769	CAPACITOR, FIXED, CERAMIC DIEL.....	EA	1
66	6	PAHZZ	5962-00-162-7505	SN7490N	01295	NETWORK, DECADE COUNTER.....	EA	4
66	7	PAHZZ		WEE120UH	83125	COIL, RADIO FREQUENCY, FIXED	EA	4
66	8	PAHZZ	5910-00-775-4045	8131M103X5V0104Z	18796	CAPACITOR, FIXED, CERAMIC DIEL.....	EA	2
66	9	PAHZZ	5905-00-106-3668	RC07GF220J	81349	RESISTOR, FIXED, COMPOSITION.....	EA	1
66	10	PAHZZ	5950-01-035-3657	CL481	82679	COIL, TOROID	EA	3
66	11	XBHZZ		NT137-2520	82679	NUT, NYLON.....	EA	3
66	12	XBHZZ		SC143-2520816W	82679	SCREW, MACHINE.....	EA	3
66	13	XBHZZ		WA109-55	82679	WASHER, FIBER	EA	3

REPAIR PARTS LIST

(1) ILLUSTRATION		(2)	(3)	(4)	(5)	(6)	(7)	(8)
(a) FIG NO.	(b) ITEM NO.	SMR CODE	NATIONAL STOCK NUMBER	PART NUMBER	FSCM	DESCRIPTION USABLE ON CODE	U/M	QTY INC IN UNIT
66	14	PAHZZ	5910-01-103-4562	F409-004	72928	CAPACITOR, FIXED, MYLAR	EA	3
66	15	PAHZZ	5905-00-104-8368	RC07GF470J	81349	RESISTOR, FIXED, COMPOSITION	EA	4
66	16	PAHZZ	5905-00-114-0710	RC07GF331J	81349	RESISTOR, FIXED, COMPOSITION	EA	1
66	17	PAHZZ		NLW10-25	56289	CAPACITOR, FIXED, ELECTROLYTIC	EA,	6
66	18	PAHZZ	5905-00-105-7764	RC07GF222J	81349	RESISTOR, FIXED, COMPOSITION	EA	1
66	19	PAHZZ		40841	82679	TRANSISTOR	EA	1
66	20	PAHZZ	5010-00-401-2903	CM112E252J1S	81349	CAPACITOR, FIXED, MICA DIEL	EA	1
66	21	PAHZZ	5905-00-116-8555	RC07GF153J	81349	RESISTOR, FIXED, COMPOSITION	EA	1
66	22	PAHZZ	5950-00-914-1928	155A3	11700	TRANSFORMER, RADIO FREQ, ADJ	EA	2
66	23	PAHZZ	5906-00-107-0656	RC07GF100J	81349	RESISTOR, FIXED, COMPOSITION	EA	4
66	24	PAHZZ	5905-00-120-9154	RC07GF471J	81349	RESISTOR, FIXED, COMPOSITION	EA	2
66	25	PAHZZ		NLW100-25	56289	CAPACITOR, FIXED, ELECTROLYTIC	EA	2
66	26	PAHZZ	5962-00-341-0544	SN7404N	01295	NETWORK, HEX INVERTER	EA	4
66	27	PAHZZ	5962-00-348-2718	SN7470N	01295	NETWORK, J-K FLIP FLOP	EA	1
66	28	PAHZZ	5905-00-131-1255	RC07GF122J	81349	RESISTOR, FIXED, COMPOSITION	EA	1
66	29	XDNZZ		PC653	82679	PRINTED WIRING BOARD	EA	1
66	30	PAHHD	5120-01-022-9717	A4928	82679	CIRCUIT CD, DIVIDER	EA	1
66	31	XBHZZ		SCBP0440BN5	82679	SCREW, MACHINE	EA	4
66	32	XBHZZ		WA109-35	82679	WASHER, FIBER	EA	4
66	33	XBHZZ		LWE06MRN	82679	WASHER, LOCK	EA	4
						GROUP 090403 CIRCUIT CARD, FIRST MIXER Z101		
67		PAHHD		A4932	82679	CIRCUIT CD, FIRST MIXER 2101	EA	1
67	1	PAFZZ	5905-00-110-7620	RC07GF102J	81349	RESISTOR, FIXED, COMPOSITION	EA	4
67	2	PAFZZ		0831-000Z5V00102	18796	CAPACITOR, FIXED, CERAMIC DIEL	EA	4
67	3	XBFZZ		0805024X5V00103M	18769	CAPACITOR, FIXED, CERAMIC DIEL	EA	7
67	4	PAFZZ	5905-00-186-698	RC07GF271J	81349	RESISTOR, FIXED, COMPOSITION	EA	3
67	5	XBFZZ		RC07GF471J	81349	RESISTOR, FIXED, COMPOSITION	EA	1
67	6	XBFZZ		RC07GF470J	81349	RESISTOR, FIXED, COMPOSITION	EA	6
67	7	PAFZZ		8131M103XSV0104Z	18796	CAPACITOR, FIXED, CERAMIC DIEL	EA	4
67	8	PAFZZ	5905-00-105-7768	RC07GF561J	81349	RESISTOR, FIXED, COMPOSITION	EA	1
67	9	PAFZZ	5905-01-034-9238	TT307-8	82679	TRANSFORMER, RADIO FREQ, ADJ	EA	2
67	10	PAFZZ		C111E471F1S	82679	CAPACITOR, FIXED, MICA DIEL	EA	1
67	11	PAFZZ	5955-01-036-7457	CR119-19R0	13075	CRYSTAL, OSCILLATOR	EA	2
67	12	PAFZZ	5905-00-114-5343	RC07GF182J	81349	RESISTOR, FIXED, COMPOSITION	EA	1
67	13	PAFZZ	5905-00-106-3666	RC07GF103J	81349	RESISTOR, FIXED, COMPOSITION	EA	2
67	14	XBFZZ		2N2368	81349	TRANSISTOR	EA	4
67	15	PAFZZ		WEE100UH	83125	COIL, RADIO FREQUENCY, FIXED	EA	5
67	16	PAFZZ		CM111E131F1S	81349	CAPACITOR, FIXED, MICA DIEL	EA	2
67	17	PAFZZ		WEE15UH	83125	COIL, RADIO FREQUENCY, FIXED	EA	1

REPAIR PARTS LIST

(1) ILLUSTRATION		(2)	(3)	(4)	(5)	(6)	(7)	(8)
(a) FIG NO.	(b) ITEM NO.	SMR CODE	NATIONAL STOCK NUMBER	PART NUMBER	FSCM	DESCRIPTION USABLE ON CODE	U/M	QTY INC IN UNIT
67	18	PAFZZ		CM111E101F1S	82679	CAPACITOR, FIXED, MICA DIEI	EA	1
67	19	PAFZZ	5905-00-141-0744	RC07GF562J	81349	RESISTOR, FIXED, COMPOSITION	EA	1
67	20	PAFZZ		CA3040	02735	NETWORK INTEGRATED, CIR AMPL	EA	1
67	21	XDHZZ		PC658	82679	PRINTED WIRING BOARD	EA	1
67	22	PAFZZ	5905-00-141-0743	RC07GF392J	81349	RESISTOR, FIXED, COMPOSITION	EA	1
67	23	PAFZZ	5905-00-110-7620	RC07GF102J	81349	RESISTOR: FIXED, COMPOSITION	EA	1
						GROUP 090404 CIRCUIT CARD, FOURTH MIXER Z103		
68		PAHZZ	5820-01-010-4979	A4925	82679	CIRCUIT COD, FOURTH MIXER	EA	1
68	1	PAFZZ	5908-00-802-6730	RC07GF470J	81349	RESISTOR, FIXED, COMPOSITION	EA	9
68	2	PAFZZ	5905-00-116-8556	RC07GF223J	81349	RESISTOR, FIXED, COMPOSITION	EA	2
68	3	XBFZZ		0805024X5V00103M	18769	CAPACITOR, FIXED, CERAMIC DIEI	EA	6
68	4	PAFZZ	5905-00-118-4559	RC07GF333J	81349	RESISTOR, FIXED, COMPOSITION	EA	1
68	5	PAFZZ		1N756A	81349	SEMICONDUCTOR DEVICE, DIODE	EA	1
68	6	PAFZZ	5905-00-141-1183	RC07GF101J	81349	RESISTOR, FIXED, COMPOSITION	EA	1
68	7	PAFZZ	5905-00-111-4727	RC07GF272J	81349	RESISTOR, FIXED, COMPOSITION	EA	1
68	8	PAFZZ	596140-02-3133	2N3646	81349	TRANSISTOR	EA	3
68	9	PAFZZ		CM111E331J1S	81349	CAPACITOR, FIXED, MICA DIEI	EA	1
68	10	PAFZZ		CM111E241J1S	81349	CAPACITOR, FIXED, MICA DIEI	EA	1
68	11	PAFZZ	5955-01--035-7458	CR109-141	82679	CRYSTAL UNIT, QUARTZ	EA	1
68	12	PAFZZ	5905-00-105-7767	RC07GF474J	81349	RESISTOR, FIXED, COMPOSITION	EA	2
68	13	XBFZZ		8131M103X5V0104Z	18796	CAPACITOR, FIXED, CERAMIC DIEI	EA	6
68	14	XBFZZ		40841	82679	TRANSISTOR	EA	2
68	15	XBFZZ		WEE120UH	83125	COIL, RADIO FREQUENCY, FIXED	EA	4
68	16	PAFZZ	5950-01-0347338	TT307-13	82679	TRANSFORMER, RADIO FREQ, ADJ	EA	1
68	17	PAFZZ		CM111E102J1S	81349	CAPACITOR, FIXED, MICA DIEI	EA	1
68	18	PAFZZ		CM112F182F1S	81349	CAPACITOR, FIXED, MICA DIEI	EA	3
68	19	PAFZZ		WEE1UH	83125	COIL, RADIO FREQUENCY, FIXED	EA	1
68	20	PAFZZ	5950-01-034-9335	TT307-11	82679	TRANSFORMER, RAODIO FREQ, ADJ	EA	2
68	21	PAFZZ	5905-00-110-0388	RC07GF104J	81349	RESISTOR, FIXED, COMPOSITION	EA	1
68	22	PAFZZ	5950-01-034-8136	TT307-12	82679	TRANSFORMER, RADIO FREQ, ADJ	EA	1
68	23	PAFZZ	5905-00-135-6046	RC07GF681J	81349	RESISTOR, FIXED, COMPOSITION	EA	1
68	24	PAFZZ	5910-00-957-2058	CM111E330J15S	81349	CAPACITOR, FIXED, MICA DIEI	EA	1
68	25	XBFZZ		RC07GF471J	81349	RESISTOR, FIXED, COMPOSITION	EA	1
68	26	XBFZZ		RC07GF122J	81349	RESISTOR, FIXED, COMPOSITION	EA	1
68	27	PAFZZ	5905-00-682-4109	RC07GF561J	81349	RESISTOR, FIXED, COMPOSITION	EA	2
68	28	PAFZZ	5910-00-936-7372	CM111E120J1S	81349	CAPACITOR, FIXED, MICA DIEI	EA	1
68	29	PAFZZ	5905-00-116-8554	RC07GF105J	81349	RESISTOR, FIXED, COMPOSITION	EA	1
68	30	PAFZZ	5910-00-471-5168	538-011-110D	18796	CAPACITOR.VARIABLE, CERAMIC	EA	1
68	31	PAFZZ	5905-00-114-0711	RC07GF472J	81349	RESISTOR.FIXED, COMPOSITION	EA	1
68	32	XDHZZ		PC650	82679	PRINTED WIRING BOARD	EA	1

REPAIR PARTS LIST

(1) ILLUSTRATION		(2)	(3)	(4)	(5)	(6)	(7)	(8)
(a) FIG NO.	(b) ITEM NO.	SMR CODE	NATIONAL STOCK NUMBER	PART NUMBER	FSCM	DESCRIPTION USABLE ON CODE	U/M	QTY INC IN UNIT
68	33	XBFZZ		SCBP0440BN5	82679	SCREW, MACHINE	EA	4
68	34	XBFZZ		WA109-35	82679	WASHER, FIBER	EA	4
68	35	XBFZZ		LWE06MRN	82679	WASHER, LOCK	EA	4
						GROUP 090405 CIRCUIT CARD, MULTIPLIER Z108		
69	1	PAFZZ	5940-00-159-0245	X1457B	71279	TERMINAL, STUD	EA	12
69	2	XDHZZ		PC654	82679	PRINTED WIRING BOARD	EA	1
69	3	PAFZZ	5910-00-905-6086	CN114-1RO	82679	CAPACITOR, FIXED, CERAMIC DIELECTRIC	EA	3
69	4	XBFZZ		NLW10-25	56289	CAPACITOR, FIXED, ELECTROLYTIC	EA	3
69	5	XBFZZ		2N2368	81349	TRANSISTOR	EA	8
69	6	PAFZZ		NLWS-25	56289	CAPACITOR, FIXED, ELECTROLYTIC	EA	3
69	7	PAFZZ	5950-01-034-9324	TT308	82679	TRANSFORMER	EA	1
69	8	PAFZZ	5950-01-034-3657	TT307-7	82679	TRANSFORMER, RADIO FREQ, ADJ	EA	3
69	9	PAFZZ		WEE10MH	83125	COIL, RADIO FREQUENCY, FIXED	EA	4
69	10	XBFZZ		40841	82679	TRANSISTOR	EA	3
69	11	XBFZZ		WEE120UH	83125	COIL, RADIO FREQUENCY, FIXED	EA	1
69	12	PAFZZ	5550-01-035-9580	TT309	82679	TRANSFORMER	EA	2
69	13	PAFZZ	5910-00-992-2473	NLW2-25	56289	CAPACITOR, FIXED, ELECTROLYTIC	EA	3
69	14	PAFZZ	5950-01-034-9336	CL482-2	82679	COIL, VARIABLE	EA	3
69	15	PAFZZ		CN127AR22	82679	CAPACITOR, POLYCARBONATE	EA	3
69	16	PAFZZ		CN127AR47	82679	CAPACITOR, POLYCARBONATE	EA	3
69	17	PAFZZ	5950-01-035-9582	CL482-1	82679	COIL, VARIABLE	EA	3
69	18	XBFZZ		0805024XSV00103M	18769	CAPACITOR, FIXED, CERAMIC DIELECTRIC	EA	2
69	19	XBFZZ		RC07GF562J	81349	RESISTOR, FIXED, COMPOSITION	EA	3
69	20	XBFZZ		RC07GF470J	81349	RESISTOR, FIXED, COMPOSITION	EA	18
69	21	XBFZZ		RC07GF272J	81349	RESISTOR, FIXED, COMPOSITION	EA	1
69	22	XBFZZ		8131M103X5V0104Z	18796	CAPACITOR, FIXED, CERAMIC DIELECTRIC	EA	7
69	23	XBFZZ	5905-00-110-7620	RC07GF102J	81349	RESISTOR, FIXED, COMPOSITION	EA	9
69	24	XBFZZ		1N914	81349	SEMICONDUCTOR DEVICE, DIODE	EA	2
69	25	XBFZZ		RC07GF103J	81349	RESISTOR, FIXED, COMPOSITION	EA	1
69	26	PAFZZ	5961-00-686-6720	1N100	81349	SEMICONDUCTOR DEVICE, DIODE	EA	6
69	27	PAFZZ	5905-00-119-3505	RC07GF683J	81349	RESISTOR, FIXED, COMPOSITION	EA	1
69	28	PAFZZ		CM111E821J1S	81349	CAPACITOR, FIXED, MICA DIELECTRIC	EA	1
69	29	XBFZZ		RC07GF471J	81349	RESISTOR, FIXED, COMPOSITION	EA	1
69	30	XBFZZ		RC07GF182J	81349	RESISTOR, FIXED, COMPOSITION	EA	1
69	31	XBFZZ		RC07GF222J	81349	RESISTOR, FIXED, COMPOSITION	EA	3
69	32	XBFZZ		RC07GF153J	81349	RESISTOR, FIXED, COMPOSITION	EA	4
69	33	PAFZZ		CM111E101J1S	81349	CAPACITOR, FIXED, MICA DIELECTRIC	EA	1
69	34	PAFZZ	5910-00-078-1529	CM112E153F1S	81349	CAPACITOR, FIXED, MICA DIELECTRIC	EA	3
69	35	XBFZZ		RC07GF100J	81349	RESISTOR, FIXED, COMPOSITION	EA	4
69	36	XBFZZ	5905-00-114-0710	RC07GF331J	81349	RESISTOR, FIXED, COMPOSITION	EA	2

REPAIR PARTS LIST

(1) ILLUSTRATION		(2)	(3)	(4)	(5)	(6)	(7)	(8)
(a) FIG NO.	(b) ITEM NO.	SMR CODE	NATIONAL STOCK NUMBER	PART NUMBER	FSCM	DESCRIPTION USABLE ON CODE	U/M	QTY INC IN UNIT
69	37	PAFZZ		CM111E102F1S	81349	CAPACITOR, FIXED, MICA DIEL	EA	1
69	38	PAFZZ	5905-00-114-0711	RC07GF472J	81349	RESISTOR, FIXED, COMPOSITION	EA	1
69	39	PAFZZ		CM112F202F1S	81349	CAPACITOR, FIXED, MICA DIEL	EA	1
69	40	XBFZZ		RC07GF333J	81349	RESISTOR, FIXED, COMPOSITION	EA	1
69	41	XBFZZ		SCBP0440BN5	82679	SCREW, MACHINE	EA	5
69	42	XDFFF		A4929	82679	CIRCUIT CD, MULTIPLIER	EA	1
						GROUP 090406 CIRCUIT CARD, PHASE DETECTOR Z109		
70		XDFFD		A4931	82679	CIRCUIT CD, PHASE DETECTOR Z109	EA	1
70	1	XBFZZ	5950-01-034-9324	TT308	82679	TRANSFORMER	EA	2
70	2	XBFZZ	5961-00-686-6720	1N100	81349	SEMICONDUCTOR DEVICE, DIODE	EA	4
70	3	XBFZZ		RC07GF562J	81349	RESISTOR, FIXED, COMPOSITION	EA	6
70	4	PAFZZ		5815000Y5U001042	18769	CAPACITOR, FIXED, CERAMIC DIEL	EA	1
70	5	PAFZZ	5905-00-120-9152	RC07GF274J	81349	RESISTOR, FIXED, COMPOSITION	EA	1
70	6	PAFZZ	5905-00-119-8768	RC07GF821J	81349	RESISTOR, FIXED, COMPOSITION	EA	1
70	7	PAFZZ	5905-00-115-8055	RC07GF393J	81349	RESISTOR, FIXED, COMPOSITION	EA	1
70	8	XBFZZ		8131M103XSV0104Z	18796	CAPACITOR, FIXED, CERAMIC DIEL	EA	12
70	9	XBFZZ		NLW100-25	56289	CAPACITOR, FIXED, ELECTROLYTIC	EA	2
70	10	XBFZZ		2N2368	81349	TRANSISTOR	EA	4
70	11	XBFZZ		0805024X5V00103M	18769	CAPACITOR, FIXED, CERAMIC ODIEL	EA	4
70	12	PAFZZ	5905-00-802-6730	RC07GF470J	81349	RESISTOR, FIXED, COMPOSITION	EA	4
70	13	PAFZZ	5905-00-682-4098	RC07GF392J	81349	RESISTOR, FIXED, COMPOSITION	EA	2
70	14	XBFZZ		RC07GF471J	81349	RESISTOR, FIXED, COMPOSITION	EA	4
70	15	XBFZZ		WEE10MH	83125	COIL, RADIO FREQUENCY, FIXED	EA	6
70	16	XBFZZ		RC07GF222J	81349	RESISTOR, FIXED, COMPOSITION	EA	5
70	17	XBFZZ		CM112F202F1S	81349	CAPACITOR, FIXED, MICA DIEL	EA	1
70	18	PAFZZ	5905-00-106-1357	RC07GF563J	81349	RESISTOR, FIXED, COMPOSITION	EA	1
70	19	PAFZZ	5910-00-832-9419	CM112F132F1S	82679	CAPACITOR, FIXED, MICA DIEL	EA	2
70	20	XBFZZ		NLW5-25	56289	CAPACITOR, FIXED, ELECTROLYTIC	EA	1
70	21	XBFZZ	5905-00-110-7620	RC07GF102J	81349	RESISTOR, FIXED, COMPOSITION	EA	1
70	22	PAFZZ	5961-00-829-0194	2N1308	81349	TRANSISTOR	EA	1
70	23	XBFZZ		RC07GF100J	81349	RESISTOR, FIXED, COMPOSITION	EA	1
70	24	PAFZZ		CM112F272F1S	82679	CAPACITOR, FIXED, MICA DIEL	EA	2
70	25	PAFZZ	5961-00-865-1151	2N1132	81349	TRANSISTOR	EA	1
70	26	PAFZZ	5905-00-127-9399	RC32GF390J	81349	RESISTOR, FIXED, CDMPOSITION	EA	1
70	27	PAFZZ	5905-00-126-6683	RC07GF332J	81349	RESISTOR, FIXED, COMPOSITION	EA	1
70	28	XDHZZ		PC657	82679	PRINTED WIRING BOARD	EA	1
70	29	XBFZZ		NT137-1032	82679	NUT, NYLON	EA	1
70	30	XBFZZ		SC143-1032812W	82679	SCREW, NYLON	EA	1
70	31	XBFZZ		WA109-54	82679	WASHER, FIBER	EA	1

REPAIR PARTS LIST

(1) ILLUSTRATION		(2)	(3)	(4)	(5)	(6) DESCRIPTION	(7)	(8)
(a) FIG NO.	(b) ITEM NO.	SMR CODE	NATIONAL STOCK NUMBER	PART NUMBER	FSCM	USABLE ON CODE	U/M	QTY INC IN UNIT
70	32	XBFZZ		NT137-1032	82679	NUT, NYLON	EA	1
70	33	XBFZZ		SC143-1032B12W	82679	SCREW, NYLON	EA	1
70	34	XBFZZ		WA109-54	82679	WASHER, FIBER	EA	1
						GROUP 090407 CIRCUIT CARD, POWER SUPPLY Z105		
71		XDFFD		A4926	82679	CIRCUIT CD, POWER SUPPLY Z105	EA	1
71	1	PAFZZ	5910-00-009-9992	BR1000-50V	09023	CAPACITOR, FIXED, ELECTROLYTIC	EA	2
71	2	XDHZZ		PC651	82679	PRINTED WIRING BOARD	EA	1
71	3	XBFZZ		SCBP04408N5	82679	SCREW, MACHINE	EA	4
71	4	XBFZZ		WA109-35	82679	WASHER, FIBER	EA	4
71	5	XBFZZ		LWE06NRN	82679	WASHER, LOCK	EA	4
71	6	PAFZZ	5961-00-462-1814	1N5256B	81349	SEMICONDUCTOR DEVICE, DIODE	EA	1
71	7	XBFZZ		RW107-1	82679	RESISTOR, FIXED, COMPOSITION	EA	2
71	8	PAFZZ	5905-00-429-9923	RC42GF271J	81349	RESISTOR, FIXED, COMPOSITION	EA	1
71	9	PAFZZ	5905-00-279-2529	RC42GF222J	81349	RESISTOR, FIXED, COMPOSITION	EA	1
71	10	PAFZZ	5961-00-054-0046	2N1711	81349	TRANSISTOR	EA	1
						GROUP 090408 CIRCUIT CARD, SECOND MIXER Z107		
72		XDFFD		A4927	82679	CIRCUIT CD, SECOND MIXER Z107	EA	1
72	1	XBFZZ		RC07GF182J	81349	RESISTOR, FIXED, COMPOSITION	EA	4
72	2	XBFZZ		RC07GF470J	81349	RESISTOR, FIXED, COMPOSITION	EA	7
72	3	XBFZZ		RC07GF271J	81349	RESISTOR, FIXED, COMPOSITION	EA	2
72	4	XBFZZ		0805024X5V00103M	18769	CAPACITOR, FIXED, CERAMIC DIEL	EA	10
72	5	XBFZZ		2N2368	81349	TRANSISTOR	EA	4
72	6	XBFZZ		RC07GF103J	81349	RESISTOR, FIXED, COMPOSITION	EA	5
72	7	XBFZZ	5905-00-110-7620	RC07GF102J	81349	RESISTOR, FIXED, COMPOSITION	EA	4
72	8	XBFZZ		RC07GF272J	61349	RESISTOR, FIXED, COMPOSITION	EA	1
72	9	PAFZZ		CM111E750GS	81349	CAPACITOR, FIXED, MICA DIEL	EA	3
72	10	PAFZZ	5905-01-034-9327	TT307-10	82679	TRANSFORMER, RADIO FREQ, ADJ	EA	1
72	11	PAFZZ	5905-00-135-3973	RC07GF221J	81349	RESISTOR, FIXED, COMPOSITION	EA	1
72	12	XBFZZ		RC07GF122J	81349	RESISTOR, FIXED, COMPOSITION	EA	1
72	13	PAFZZ		CM111E132G1S	81349	CAPACITOR, FIXED, MICA DIEL	EA	1
72	14	PAFZZ		WEE82UH	83125	COIL, RADIO FREQUENCY, FIXED	EA	2
72	15	PAFZZ		CM111E510G1S	81349	CAPACITOR, FIXED, MICA DIEL	EA	1
72	16	PAFZZ	5910-00-995-0614	CM111E221G1S	81349	CAPACITOR, FIXED, MICA DIEL	EA	1
72	17	PAFZZ		WEE1-2UH	83125	COIL, RADIO FREQUENCY, FIXED	EA	2
72	18	PAFZZ	5910-00-889-4975	CM111E6260G1S	81349	CAPACITOR, FIXED, MICA DIEL	EA	2
72	19	XBFZZ	5905-00-114-0710	RC07GF331J	81349	RESISTOR, FIXED, COMPOSITION	EA	2
72	20	PAFZZ		WEE1-SUH	83125	COIL, RADIO FREQUENCY, FIXED	EA	1
72	21	PAFZZ		CM111E181G1S	81349	CAPACITOR, FIXED, MICA DIEL	EA	2

REPAIR PARTS LIST

(1) ILLUSTRATION		(2)	(3)	(4)	(5)	(6)	(7)	(8)
(a) FIG NO.	(b) ITEM NO.	SMR CODE	NATIONAL STOCK NUMBER	PART NUMBER	FSCM	DESCRIPTION USABLE ON CODE	U/M	QTY INC IN UNIT
72	22	PAFZZ	5910-00-92-7046	CM111E560G1S	81349	CAPACITOR, FIXED, MICA DIEL	EA	1
72	23	XBFZZ		WEE1UH	83125	COIL, RADIO FREQUENCY, FIXED	EA	3
72	24	PAFZZ		CM111E361G1S	81349	CAPACITOR, FIXED, MICA DIEL	EA	1
72	25	XBFZZ		WEE100UH	83125	COIL, RADIO FREQUENCY, FIXED	EA	1
72	26	PAFZZ	5910-00-781-7929	CM111E910G1S	81349	CAPACITOR, FIXED, MICA DIEL	EA	1
72	27	XBFZZ		RC07GF101J	81349	RESISTOR, FIXED, COMPOSITION	EA	4
72	28	PAFZZ	5905-00-246-9393	RC07GF4R7J	81349	RESISTOR, FIXED, COMPOSITION	EA	1
72	29	XBFZZ		0831-000Z5V00102	18796	CAPACITOR, FIXED, CERAMIC DIEL	EA	4
72	30	PAFZZ		CM111E121G1S	81349	CAPACITOR, FIXED, MICA DIEL	EA	1
72	31	PAFZZ		CM111E100D1S	81349	CAPACITOR, FIXED, MICA DIEL	EA	1
72	32	PAFZZ		CM111E470G1S	81349	CAPACITOR, FIXED, MICA DIEL	EA	1
72	33	PAFZZ	5910-01-079-5688	CM111E131G1S	81349	CAPACITOR, FIXED, MICA DIEL	EA	1
72	34	PAFZZ		CM111E151G1S	81349	CAPACITOR, FIXED, MICA DIEL	EA	1
72	35	PAFZZ		CM111E300G1S	81349	CAPACITOR, FIXED, MICA DIEL	EA	1
72	36	XBFZZ		WEE120UH	83125	COIL, RADIO FREQUENCY, FIXED	EA	2
72	37	XBFZZ		8131M103X5V0104Z	18796	CAPACITOR, FIXED, CERAMIC DIEL	EA	2
72	38	XBFZZ		RC07GF222J	81349	RESISTOR, FIXED, COMPOSITION	EA	1
72	39	PAFZZ	5950-01-034-9334	TT307-9	82679	TRANSFORMER, RADIO FREQ, ADJ	EA	1
72	40	PAFZZ		CM111E05001S	81349	CAPACITOR, FIXED, MICA DIEL	EA	1
72	41	XBFZZ		40841	82679	TRANSISTOR	EA	1
72	42	XDHZZ		PC652	82679	PRINTED WIRING BOARD	EA	1
72	43	XBFZZ		SCBP0440BN5	82679	SCREW, MACHINE	EA	4
72	44	XBFZZ		WA109-35	82679	WASHER, FIBER	EA	4
72	45	XBFZZ		LWE06MRN	82679	WASHER, LOCK	EA	4
						GROUP 090409 CIRCUIT CARD, SPECTRUM GENERATOR Z102		
73		PAHHD	6820-01-022-9718	A4922	82679	CIRCUIT CDSPECTRUM GENERATOR Z102	EA	1
73	1	XBFZZ		RC07GF681J	81349	RESISTOR, FIXED, COMPOSITION	EA	16
73	2	XBFZZ		2N2368	81349	TRANSISTOR	EA	48
73	3	PAHZZ	6950-01-034-9328	TT307-1	82679	TRANSFORMER, RADIO FREQUENCY	EA	6
73	4	PAHZZ	5960-01-034-9332	TT307-2	82679	TRANSFORMER, RADIO FREQUENCY	EA	4
73	5	PAHZZ	5950-01-036-5199	TT307-15	82679	TRANSFORMER, RADIO FREQUENCY	EA	1
73	6	PAHZZ	5950-01-034-9330	TT307-5	82679	TRANSFORMER, RADIO FREQUENCY	EA	1
73	7	PAHZZ	5950-01-036-9331	TT307-16	82679	TRANSFORMER, RADIO FREQUENCY	EA	1
73	8	PAHZZ	5950-01-034-8141	TT307-14	82679	TRANSFORMER, RADIO FREQUENCY	EA	1
73	9	PAHZZ	5950-01-034-9337	TT307-6	82679	TRANSFORMER, RADIO FREQUENCY	EA	3
73	10	XBFZZ		40841	82679	TRANSISTOR	EA	2
73	11	XBFZZ		SN7490N	01295	NETWORK, OCADE COUNTER	EA	4
73	12	PAHZZ	5962-00-481-9677	SN7400N	09134	NETWORK, QUAD, POSITIVE NANDGATE	EA	7
73	13	XBFZZ		NLW10-25	56289	CAPACITOR, FIXED, ELECTROLYTIC	EA	1
73	14	XBFZZ		SN7404N	01295	NETWORK, HEX INVERTER	EA	3

REPAIR PARTS LIST

(1) ILLUSTRATION		(2)	(3)	(4)	(5)	(6)	(7)	(8)
(a) FIG NO.	(b) ITEM NO.	SMR CODE	NATIONAL STOCK NUMBER	PART NUMBER	FSCM	DESCRIPTION USABLE ON CODE	U/M	QTY INC IN UNIT
73	15	PAHZZ	5962-00-250-4824	SN74154N	01295	NETWORK, DECODER OEMULTIPLEXER	EA	1
73	16	PAHZZ	5962-00-229-8500	SN7405N	01295	NETWORK, HEX INVERTER	EA	5
73	17	PAHZZ		SN74184N	02195	NETWORK, BCD-BINARY CONVERTER	EA	1
73	18	PAHZZ	5962-00-172-5578	SN74L86N	01295	NETWORK, DECADE COUNTER	EA	1
73	19	PAHZZ	5962-00-106-4282	SN7473N	01295	NETWORK, DUAL J-K, FLIP-FLOP	EA	3
73	20	XBFZZ		WEE120UH	83125	COIL, RADIO FREQUENCY, FIXED	EA	6
73	21	PAHZZ	5950-01-034-9325	TT307-4	82679	TRANSFORMER, RADIO FREQUENCY	EA	1
73	22	XBFZZ		RC07GF392J	81349	RESISTOR, FIXED, COMPOSITION	EA	10
73	23	XBFZZ	5905-00-110-7620	RC07GF102J	81349	RESISTOR, FIXED, COMPOSITION	EA	4
73	24	XBFZZ		RC07GF101J	81349	RESISTOR, FIXED, COMPOSITION	EA	17
73	25	PAHZZ		CR119-9RO	82679	CRYSTAL UNIT, QUARTZ	EA	2
73	26	PAHZZ	5955-01-035-7495	CR119-13RO	82679	CRYSTAL UNIT, QUARTZ	EA	2
73	27	PAHZZ	5955-00-459-4251	CR119-11RO	82679	CRYSTAL UNIT, QUARTZ	EA	2
73	28	PAHZZ		CR119-8RO	82679	CRYSTAL UNIT, QUARTZ	EA	2
73	29	PAHZZ	5905-00-806-0636	RC07GF330J	81349	RESISTOR, FIXED, COMPOSITION	EA	1
73	30	XBFZZ		1N100	81349	SEMICONDUCTOR DEVICE, DIODE	EA	5
73	31	XBFZZ		RC07GF271J	81349	RESISTOR, FIXED, COMPOSITION	EA	20
73	32	XBFZZ		RC07GF220J	81349	RESISTOR, FIXED, COMPOSITION	EA	3
73	33	XBFZZ		RC07GF470J	81349	RESISTOR, FIXED, COMPOSITION	EA	39
73	34	PAHZZ		WEE12UH	83125	COIL, RADIO FREQUENCY, FIXED	EA	6
73	35	XBFZZ		RC07GF122J	81349	RESISTOR, FIXED, COMPOSITION	EA	3
73	36	PAHZZ	5955-00-459-4273	CR119-17R0	82679	CRYSTAL UNIT, QUARTZ	EA	2
73	37	PAHZZ	5955-00-459-4247	CR119-10R0	82679	CRYSTAL UNIT, QUARTZ	EA	2
73	38	XBFZZ		1N914	81349	SEMICONDUCTOR DEVICE, DIODE	EA	5
73	39	PAHZZ	5955-00-459-4252	CR119-12R0	82679	CRYSTAL UNIT, QUARTZ	EA	2
73	40	XBFZZ		0805024X5V00103M	18769	CAPACITOR, FIXED, CERAMIC DIELECTRIC	EA	70
73	41	PAHZZ	5955-00-459-4253	CR119-14R0	82679	CRYSTAL UNIT, QUARTZ	EA	2
73	42	PAHZZ	5955-01-036-7480	CR119-15R0	82679	CRYSTAL UNIT, QUARTZ	EA	2
73	43	XBFZZ		RC07GF221J	81349	RESISTOR, FIXED, COMPOSITION	EA	17
73	44	XBFZZ		RC07GF222J	81349	RESISTOR, FIXED, COMPOSITION	EA	1
73	45	XBFZZ		RC07GF471J	81349	RESISTOR, FIXED, COMPOSITION	EA	6
73	46	XBFZZ		RC07GF103J	81349	RESISTOR, FIXED, COMPOSITION	EA	3
73	47	XBFZZ		RC07GF182J	81349	RESISTOR, FIXED, COMPOSITION	EA	1
73	49	XBFZZ		RC07GF561J	81349	RESISTOR, FIXED, COMPOSITION	EA	1
73	50	XBFZZ		RC07GF821J	81349	RESISTOR, FIXED, COMPOSITION	EA	1
73	51	XBFZZ		RC07GF104J	81349	RESISTOR, FIXED, COMPOSITION	EA	1
73	52	XBFZZ		RC07GF100J	81349	RESISTOR, FIXED, COMPOSITION	EA	1
73	53	XBFZZ		0831-000Z5V00102	18796	CAPACITOR, FIXED, CERAMIC DIELECTRIC	EA	30
73	54	PAHZZ		CM111E471J1S	81349	CAPACITOR, FIXED, MICA DIELECTRIC	EA	1
73	55	PAHZZ		CM112F103F1S	81349	CAPACITOR, FIXED, MICA DIELECTRIC	EA	3

REPAIR PARTS LIST

(1) ILLUSTRATION		(2)	(3)	(4)	(5)	(6) DESCRIPTION	(7)	(8)
(a) FIG NO.	(b) ITEM NO.	SMR CODE	NATIONAL STOCK NUMBER	PART NUMBER	FSCM	USABLE ON CODE	U/M	QTY INC IN UNIT
73	56	PAHZZ		8131M103X5V0104Z	18796	CAPACITOR, FIXED, CERAMIC DIEI	EA	26
73	57	PANZZ		CM112E152J1S	81349	CAPACITOR, FIXED, CERAMIC DIEI	EA	1
73	58	PAHZZ	5910-00-905-6086	TYPE315-10	09134	CAPACITOR, FIXED, MYLAR DIEI	EA	1
73	59	PAHZZ		CM112E182J1S	81349	CAPACITOR, FIXED, MICA DIEI	EA	3
73	60	PAHZZ	5962-00-274-4122	SN74155N	01295	NETWORK, DECODER DEMULTIPLEXER	EA	1
73	61	PAHZZ	5910-00-754-5498	CM111E181J1S	81349	CAPACITOR, FIXED, MICA DIEI	EA	1
73	62	PAHZZ		CM111E111J1S	81349	CAPACITOR, FIXED, MICA DIEI	EA	2
73	63	PAHZZ		CM111E201J1S	81349	CAPACITOR, FIXED, MICA DIEI	EA	1
73	64	PAHZZ	5910-00-079-5688	CM111E131J1S	81349	CAPACITOR, FIXED, MICA DIEI	EA	1
73	65	PAHZZ		CM111E101J1S	81349	CAPACITOR, FIXED, MICA DIEI	EA	1
73	66	PAHZZ		CM112E162J1S	81349	CAPACITOR, FIXED, MICA DIEI	EA	1
73	67	PAHZZ		CM111E161J1S	81349	CAPACITOR, FIXED, MICA DIEI	EA	1
73	68	PAHZZ	5910-00-954-5504	CM111E121J1S	81349	CAPACITOR, FIXED, MICA DIEI	EA	1
73	69	PAHZZ	5910-00-954-5500	CM111E151J1S	81349	CAPACITOR, FIXED, MICA DIEI	EA	1
73	70	PAHZZ		CM111E331J1S	81349	CAPACITOR, FIXED, MICA DIEI	EA	1
73	71	PAHZZ	5910-00-974-5589	CM111E030J1S	81349	CAPACITOR, FIXED, MICA DIEI	EA	1
73	72	PAHZZ	5910-00-995-0614	CM111E221J1S	81349	CAPACITOR, FIXED, MICA DIEI	EA	1
73	73	PAHZZ	5910-00-957-9909	CM111E391J1S	81349	CAPACITOR, FIXED, MICA DIEI	EA	1
73	74	PAHZZ	5910-00-056-7976	CM111E271J1S	81349	CAPACITOR, FIXED, MICA DIEI	EA	1
73	75	PAHZZ	5910-00-952-7046	CM111E561J1S	81349	CAPACITOR, FIXED, MICA DIEI	EA	1
73	76	PAHZZ		CM111E301J1S	81349	CAPACITOR, FIXED, MICA DIEI	EA	1
73	77	PAHZZ		CM111E821J1S	81349	CAPACITOR, FIXED, MICA DIEI	EA	1
73	78	PAHZZ	5050-01-034-9329	TT307-3	82679	TRANSFORMER, RADIO FREQUENCY	EA	3
						GROUP 090410 CIRCUIT CARD, THIRD MIXER Z106		
74		XDFFD		A4923	82679	CIRCUIT CD, THIRD MIXER, Z106	EA	1
74	1	XBFZZ		0831-000Z5V00102	18796	CAPACITOR, FIXED, CERAMIC DIEI	EA	6
74	2	XBFZZ		RC07GF103J	81349	RESISTOR, FIXED, COMPOSITION	EA	3
74	3	XBFZZ		WEE15UH	83125	COIL.RADIO FREQUENCY, FIXED	EA	1
74	4	XBFZZ		2N2368	81349	TRANSISTOR	EA	6
74	5	XBFZZ		0805024X5V00103M	18769	CAPACITOR, FIXED, CERAMIC DIEI	EA	6
74	6	XBFZZ	5905-00-114-0710	RC07GF331J	81349	RESISTOR, FIXED, COMPOSITION	EA	1
74	7	XBFZZ		RC07GF470J	81349	RESISTOR, FIXED, COMPOSITION	EA	5
74	8	XBFZZ		WEE120UH	83125	COIL, RADIO FREQUENCY, FIXED	EA	5
74	9	PAFZZ	5811-00-349-8742	M6	27956	MIXER, BALANCED	EA	1
74	10	XBFZZ		CM111E471J1S	81349	CAPACITOR.FIXED, MICA DIEI	EA	1
74	11	XBFZZ	5905-00-110-7620	RC07GF102J	81349	RESISTOR, FIXED, COMPOSITION	EA	7
74	12	XBFZZ		RC07GF392J	81349	RESISTOR, FIXED, COMPOSITION	EA	1
74	13	XBFZZ		RC07GF271J	81349	RESISTOR, FIXED, COMPOSITION	EA	2
74	14	XBFZZ		8131M103X5V104Z	16796	CAPACITOR, FIXED, CERAMIC, DIEI	EA	6
74	15	XBFZZ		RC07GF182J	81349	RESISTOR, FIXED, COMPOSITION	EA	3

REPAIR PARTS LIST

(1) ILLUSTRATION		(2)	(3)	(4)	(5)	(6) DESCRIPTION	(7)	(8)
(a) FIG NO.	(b) ITEM NO.	SMR CODE	NATIONAL STOCK NUMBER	PART NUMBER	FSCM	USABLE ON CODE	U/M	QTY INC IN UNIT
74	16	XBFZZ		RC07GF471J	81349	RESISTOR, FIXED, COMPOSITION	EA	1
74	17	XBFZZ		CM111E241J1S	81349	CAPACITOR, FIXED, MICA DIEL	EA	1
74	18	PAFZZ		WEE56UH	83125	COIL, RADIO FREQUENCY, FIXED	EA	2
74	19	XBFZZ		CM111E121J1S	81349	CAPACITOR, FIXED, MICA DIEL	EA	2
74	20	XBFZZ		WEE10MH	83125	COIL, RADIO FREQUENCY, FIXED	EA	1
74	21	PAFZZ		NLW50-15	56289	CAPACITOR, FIXED, ELECTROLYTIC	EA	1
74	22	XAFZZ		PC646	82679	PRINTED WIRING BOARD	EA	1
74	23	PAFZZ	5905-00-141-0742	RC07GF181J	81349	RESISTOR, FIXED, COMPOSITION	EA	1
74	24	XBFZZ		CM111E221J1S	81349	CAPACITOR, FIXED, MICA DIEL	EA	1
74	25	PAFZZ	5955-01-035-7468	CR119-14R545	82679	CRYSTAL UNIT, QUARTZ	EA	2
74	26	PAFZZ	5905-00-104-8363	RC07GF820J	81349	RESISTDR, FIXED, COMPOSITION	EA	1
						GROUP 0905 CONVERTER, SINGLE-DOUBLE SIDEBAND CV-3300/TSC-25		
75		PAFZZ	5820-00-149-1119	CV330/TSC-25		CONVERTER, SINGLE-DOUBLE SIDEBAND CV- 3300/TSC-25	EA	1
75	1	PAFZZ	6625-00-669-0769	SMC283217	80063	METER, VU	EA	1
75	2	PAFZZ	6625-00-827-4651	MR13S100DCUAR	81349	AMMETER	EA	1
75	2A	PDFDD		SMD180300	80063	PANEL ASSEMBLY, CONTROL	EA	1
75	3	XBFZZ		SMB180302	80063	HANDLE	EA	2
75	4	PDFFD	5995-00-926-3373	CG409EU	82679	CABLE ASSEMBLY, RF	EA	1
75	5	XBFZZ	6145-00-542-6092	RG58CU	96906	CABLE, RADIO, FREQUENCY	EA	1
75	6	PAFZZ	5935-00-681-5685	UG88CU	81349	CODNNECTOR.PLUG, ELECTRICAL	EA	2
75	7	XAFZZ		SMB180490	80063	CABLE ASSEMBLY	EA	1
75	8	PAFZZ		32635MG4LC	74193	CIRCUIT BREAKER	EA	1
75	9	PAFZZ	5935-00-295-5361	7259	74545	CONNECTOR, ELECTRICAL, RECEPCTL	EA	1
75	10	PAFZZ	6240-00-155-8706	47	24446	LAMP INCANDESCENT	EA	1
75	11	XBFZZ		SM180490-2	80063	CABLE POWER ELECTRICAL	EA	1
75	12	PAFZZ	5935-00-149-4013	7057	74545	CONNECTOR.PLUG, ELECTRICAL	EA	1
75	13	PDFFD	5995-00-686-4214	CD370	82679	CABLE POWER, ELECTRICAL	EA	1
75	14	XBFZZ		SMD180300-2	80063	JACK, TELEPHONE	EA	1
75	15	XBFZZ		SMB180491	80063	STRIP ASSEMBLY, FANNING	EA	2
75	16A	XBFZZ		SMB180493	80063	STRIP ASSEMBLY, FANNING	EA	2
75	17	PDFFD	5995-00-538-9030	SMB180489	80063	CABLE ASSEMBLY, AGC	EA	2

REPAIR PARTS LIST

(1) ILLUSTRATION		(2)	(3)	(4)	(5)	(6)	(7)	(8)
(a) FIG NO.	(b) ITEM NO.	SMR CODE	NATIONAL STOCK NUMBER	PART NUMBER	FSCM	DESCRIPTION USABLE ON CODE	U/M	QTY INC IN UNIT
75	18	XBFZZ		SM0180495	80063	COVER ASSEMBLY/TOP/ GROUP 0905060201 RF CHASSIS ASSEMBLY	EA	1
76	1	PAFZZ	5910-00-567-2667	186P10401S5	56289	CAPACITOR, FIXED, ELECTROLYTIC	EA	8
76	2	PAFZZ	5910-00-668-5903	186P47301S5	56289	CAPACITOR, FIXED, ELECTROLYTIC	EA	2
76	3	PAFZZ	5960-00-262-0210	5B14A	81349	ELECTRON TUBE	EA	13
76	4	PAFZZ	5910-00-925-6106	CE42C300Q	81349	CAPACITOR, FIXED, ELECTROLYTIC	EA	2
76	5	PAFZZ		186P104045S	56289	CAPACITOR, FIXED, ELECTROLYTIC	EA	17
76	6	PAFZZ	5905-00-501-5184	RV4LAYS5A503A	81349	RESISTOR, VARIABLE	EA	1
76	7	PAFZZ	5950-00-645-6869	CB848	04213	TRANSFORMER, RADIO.FREQUENCY	EA	2
76	8	PAFZZ		186P10404S5-2	56289	CAPACITOR, FXD, ELECTROLYTIC	EA	1
76	9	PAFZZ		CB847	04213	TRANSFORMER, RADIO, FREQUENCY	EA	1
76	10	PAFZZ	5960-00-729-6963	6U8A	81349	ELECTRON TUBE	EA	1
76	11	PAFZZ		CB847-2	04213	TRANSFORMER, RADIO, FREQUENCY	EA	3
76	12	PAFZZ		BG200-73EX100KC	03040	OVEN ASSEMBLY, CRYSTAL	EA	1
76	13	PAFZZ	5960-00-179-3710	6AU6WB	81349	ELECTRON TUBE	EA	8
76	14	PAFZZ	5910-00-578-1623	CV11C450	81349	CAPACITOR, VAR, CER, DIELECTRIC	EA	4
76	15	PAFZZ	5960-00-082-4139	5751WA	81349	ELECTRON TUBE	EA	9
76	16	PAFZZ		CB846	04213	TRANSFORMER, RADIO, FREQUENCY	EA	4
76	17	XBFZZ	5960-00-879-5078	5726	81349	ELECTRON TUBE	EA	3
76	17A	PAFZZ	5935-00-260-0516	TS102P01	81349	SOCKET, ELECTRON, TUBE	EA	9

REPAIR PARTS LIST

(1) ILLUSTRATION		(2)	(3)	(4)	(5)	(6)	(7)	(8)
(a) FIG NO.	(b) ITEM NO.	SMR CODE	NATIONAL STOCK NUMBER	PART NUMBER	FSCM	DESCRIPTION USABLE ON CODE	U/M	QTY INC IN UNIT
76	18	PAFZZ	5910-00-666-8429	186P10402S5	56289	CAPACITOR, FIXED, ELECTROLYTIC	EA	1
76	19	PAFZZ	5910-00-668-5903	186P47301S5	56289	CAPACITOR, FIXED, ELECTROLYTIC	EA	1
76	20	PAFZZ		CB845	04213	TRANSFORMER, RADIO FREQUENCY	EA	1
76	21	PAFDD	5820-00-581-2601	SMD180327	80063	AFC UNIT ASSEMBLY	EA	1
76	22	PAFZZ	5960-00-188-0806	6BA7	81349	ELECTRON TUBE	EA	1
76	22A	PAFZZ	5935-00-222-9826	TS103P01	81349	SOCKET, ELECTRON, TUBE	EA	21
76	23	PAFZZ		RV4LAXSA252A	81349	RESISTOR, VARIABLE	EA	1
76	24	PAFZZ		CB849	04213	COIL, RF	EA	1
76	25	PAFZZ	5910-00-681-2283	CP54B1EE504V	81349	CAPACITOR, FXD, PPR, DIELECTRIC	EA	1
76	26	PAFZZ	5910-00-681-2283	CP54B1EE504V	81349	CAPACITOR, FXD, PPR, DIELECTRIC	EA	1
76	27	PAFZZ	5910-00-129-9234	CP53B1EB105V	81349	CAPACITOR, FXD, PPR, DIELECTRIC	EA	1
76	28	PAFZZ		P302N12UF150V	00656	CAPACITOR, FXD, METALLIC P D	EA	1
76	29	PAFZZ	5910-00-667-4996	186P10301S5	56289	CAPACITOR, FIXED, ELECTROLYTIC	EA	1
76	30	XBFZZ		SMB180465	80063	KNOB	EA	1
76	31	PAFZZ		11726-136	80503	CAPACITOR, VARIABLE	EA	1
76	32	PAFZZ	6625-00-783-5145	SMC283217	80063	METER, VU	EA	1
76	33	PAFZZ		186P10401512	56289	CAPACITOR, FIXED, ELECTROLYTIC	EA	1
76	34	PAFZZ		0-2552	21937	TRANSFORMER, POWER, STEPUP	EA	2
76	35	PAFZZ	5915-00-501-4054	SMC180369	80063	FILTER, AUDIO	EA	2
76	36	PAFZZ	5910-00-421-6310	CE42C450J	81349	CAPACITOR, FIXED, ELECTROLYTIC	EA	1
76	37	PAFZZ	5930-00-309-3993	SMC180471	80063	SWITCH, ROTARY	EA	1
76	38	PAFZZ	5910-00-925-6106	CE42C300Q	81349	CAPACITOR, FIXED, ELECTROLYTIC	EA	1
76	39	PAFZZ	5905-00-552-2093	RV4LAXSA254A	81349	RESISTOR, VARIABLE	EA	1
76	40	PAFZZ		6AQ5WA	81349	ELECTRON TUBE	EA	1
76	41	XBFZZ		SMD180170	80063	FRAME ASSEMBLY	EA	1
77	1	PAFZZ		MCP12A2KB222M	81349	CAPICITOR, FXD, PPR, DIELECTRIC	EA	1
77	2	PAFZZ	5910-00-556-9440	CV11A070	81349	CAPACITOR, VAR, CER, DIELECTRIC	EA	1
77	3	PAFZZ	5905-00-108-6922	C20GF151J	81349	RESISTOR, FIXED, COMPOSITION	EA	1
77	4	PAFZZ	5905-00-539-2567	RV4LAYSAS252A	81349	RESISTOR, VARIABLE	EA	2
77	5	PAFZZ		RV4NAYFD103C	81349	RESISTOR, VARIABLE	EA	2
77	6	PAFZZ	5910-00-681-2283	CP54B1EE504V	81349	CAPICITOR, FIXED, DIELECTRIC	EA	1
77	7	PAFZZ	5905-00-518-5593	RV4LAYSAS504A	81349	RESISTOR, VARIABLE	EA	2
77	8	PAFZZ	6145-00-542-6682	SMC180368	80063	SWITCH, ROTARY	EA	1
77	9	PAFZZ	5930-00-548-8634	SMC180307	80063	SWITCH, ROTARY	EA	1
77	10	PAFZZ	5905-00-518-5595	RV4LAYSAS103A	81349	RESISTOR, VARIABLE	EA	2
77	11	PAFZZ	5910-00-806-9160	196P47304513	56289	CAPACITOR, FIXED, ELECTROLYTIC	EA	1
77	12	PAFZZ	5905-00-501-5184	RV4LAYSAS503A	81349	RESISTOR, VARIABLE	EA	1
77	13	PAFZZ	5905-00-646-5958	RV4LAYSAS102A	81349	RESISTOR, VARIABLE	EA	1
77	14	XBFZZ		SMB180455	80063	TERMINAL BOARD	EA	1
77	14A	XDFFF		SMC180454	80063	TERMINAL BOARD	EA	1

REPAIR PARTS LIST

(1) ILLUSTRATION		(2)	(3)	(4)	(5)	(6)	(7)	(8)
(a) FIG NO.	(b) ITEM NO.	SMR CODE	NATIONAL STOCK NUMBER	PART NUMBER	FSCM	DESCRIPTION USABLE ON CODE	U/M	QTY INC IN UNIT
77	15	PAFZZ	5905-00-106-9348	RC20GF153J	81349	RESISTOR, FIXED, COMPOSITION	EA	1
77	16	PAFZZ	5905-00-141-0592	RC20GF122J	81349	RESISTOR, FIXED, COMPOSITION	EA	1
77	17	PAFZZ	5905-00-141-1071	RC20GF474J	81349	RESISTOR, FIXED, COMPOSITION	EA	1
77	18	PAFZZ	5905-00-104-5756	RC20GF105J	81349	RESISTOR, FIXED, COMPOSITION	EA	1
77	19	PAFZZ	5905-00-114-542e	RC20GF394J	81349	RESISTOR, FIXED, COMPOSITION	EA	1
77	20	PAFZZ	5905-00-110-0993	RC20GF123J	81349	RESISTOR, FIXED, COMPOSITION	EA	1
77	21	PAFZZ	5910-00-806-9160	196P47304513	56289	CAPACITOR, FIXED, ELECTROLYTIC	EA	1
77	22	XDFFF		SMB180452	80063	TERMINAL BOARD	EA	1
77	22A	XDFFF		SMB180451	80063	TERMINAL BOARD	EA	1
77	23	PAFZZ	5905-00-104-5756	RC20GF105J	81349	RESISTOR, FIXED, COMPOSITION	EA	2
77	24	PAFZZ	5905-00-104-8335	RC20GF124J	81349	RESISTOR, FIXED, COMPOSITION	EA	2
77	25	PAFZZ	5905-00-104-8346	RC20GF334J	81349	RESISTOR, FIXED, COMPOSITION	EA	1
77	26	PAFZZ	5905-00-141-1149	RC32GF391J	81349	RESISTOR, FIXED, COMPOSITION	EA	1
77	27	PAFZZ	5905-00-279-2528	RC42GF682J	81349	RESISTOR, FIXED, COMPOSITION	EA	2
77	28	PAFZZ	5905-00-121-9861	RC32GF102J	81349	RESISTOR, FIXED, COMPOSITION	EA	1
77	29	XBFZZ		SMB180425	80063	TERMINAL BOARD	EA	1
77	29A	XDFFF		SMB180424	80063	TERMINAL BOARD	EA	1
77	30	PAFZZ	5905-00-141-0592	RC20GF122J	81349	RESISTOR, FIXED, COMPOSITION	EA	1
77	31	PAFZZ	5905-00-111-4738	RC20GF152J	81349	RESISTOR, FIXED, COMPOSITION	EA	2
77	32	PAFZZ	5905-00-141-1168	RC20GF222J	81349	RESISTOR, FIXED, COMPOSITION	EA	1
77	33	PAFZZ	5905-00-104-8348	RC20GF332J	81349	RESISTOR, FIXED, COMPOSITION	EA	1
77	34	PAFZZ	5905-00-104-8330	RC20GF333J	81349	RESISTOR, FIXED, COMPOSITION	EA	1
77	35	PAFZZ	5905-00-141-0595	RC20GF472J	81349	RESISTOR, FIXED, COMPOSITION	EA	1
77	36	PAFZZ		CM15E331J	81349	CAPACITOR, FXD, MICA DIELECTRIC	EA	1
77	37	PAFZZ	5940-00-092-1354	SMB180419	80063	TERMINAL BOARD	EA	1
77	38	PAFZZ	5905-00-111-4858	RC20GF471J	81349	RESISTOR, FIXED, COMPOSITION	EA	1
77	39	PAFZZ	5905-00-106-9348	RC20GF154J	81349	RESISTOR, FIXED, COMPOSITION	EA	1
77	40	PAFZZ	5905-00-106-9348	RC20GF153J	81349	RESISTOR, FIXED, COMPOSITION	EA	1
77	41	PAFZZ	5940-00-092-1375	SMB180416	80063	TERMINAL BOARD	EA	1
77	41A	XDFFF		SMC180415	80063	TERMINAL BOARD	EA	1
77	42	PAFZZ	5905-00-104-8332	RC20GF475J	81349	RESISTOR, FIXED, COMPOSITION	EA	1
77	43	PAFZZ	5905-00-104-8348	RC20GF332J	81349	RESISTOR, FIXED, COMPOSITION	EA	1
77	44	PAFZZ	5605-00-279-2522	RC20F154J	81349	RESISTOR, FIXED, COMPOSITION	EA	1
77	45	PAFZZ	5910-00-725-7647	CM15C220J	81349	CAPACITOR, FXD, MICA, DIELECTRIC	EA	1
77	46	PAFZZ	5910-00-667-5110	186P10402S12	56289	CAPACITOR, FIXED, ELECTROLYTIC	EA	1
77	47	PAFZZ		196P10401S13	56289	CAPACITOR, FIXED, ELECTROLYTIC	EA	1
77	48	PAFZZ	5905-00-114-5489	RC20GF823J	81349	RESISTOR, FIXED, COMPOSITION	EA	1
77	49	PAFZZ	5905-00-141-1071	RC20GF474J	81349	RESISTOR, FIXED, COMPOSITION	EA	1
77	50	PAFZZ	5905-00-111-4858	RC20GF471J	81349	RESISTOR, FIXED, COMPOSITION	EA	1

REPAIR PARTS LIST

(1) ILLUSTRATION		(2)	(3)	(4)	(5)	(6) DESCRIPTION	(7)	(8)
(a) FIG NO.	(b) ITEM NO.	SMR CODE	NATIONAL STOCK NUMBER	PART NUMBER	FSCM	USABLE ON CODE	U/M	QTY INC IN UNIT
77	51	PAFZZ	5905-00-106-9348	RC20GF153J	81349	RESISTOR, FIXED, COMPOSITION	EA	1
77	52	PAFZZ	5905-00-104-5756	RC20GF105J	81349	RESISTOR, FIXED, COMPOSITION	EA	1
77	53	PAFZZ	5905-00-104-8346	RC20GF334J	81349	RESISTOR, FIXED, COMPOSITION	EA	1
77	54	PAFZZ	5905-00-106-9348	RC20GF154J	81349	RESISTOR, FIXED, COMPOSITION	EA	1
77	55	PAFZZ	5940-00-092-1373	SMB180413	80063	TERMINAL BOARD	EA	1
77	55A	XBFZZ		SMD180343-47	80063	NUT, PLAIN, HEXAGON	EA	2
77	56	PAFZZ	5905-00-116-8566	RC20GF680J	81349	RESISTOR, FIXED, COMPOSITION	EA	1
71	57	PAFZZ	5905-00-104-8330	RC20GF333J	81349	RESISTOR, FIXED, COMPOSITION	EA	2
77	58	PAFZZ	5905-00-141-0593	RC20GF182J	81349	RESISTOR, FIXED, COMPOSITION	EA	2
77	59	PAFZZ	5905-00-114-5361	RC20GF121J	81349	RESISTOR, FIXED, COMPOSITION	EA	1
77	60	PAFZZ	5910-00-436-1064	186P10404S12	56289	CAPACITOR, FIXED, ELECTROLYTIC	EA	2
77	61	PAFZZ	5910-00-543-9299	CE63C060Q	81349	CAPACITOR, FIXED, ELECTROLYTIC	EA	1
77	62	PAFZZ	5910-00-666-7599	CE61C060Q	81349	CAPACITOR, FIXED, ELECTROLYTIC	EA	1
77	63	PAFZZ	5910-00-538-7731	CE63C200J	81349	CAPACITOR, FIXED, ELECTROLYTIC	EA	1
77	64	PAFZZ	5940-00-092-1365	SM8180440	80063	TERMINAL BOARD	EA	1
77	64A	XBFZZ		SMC180439	80063	TERMINAL BOARD	EA	1
77	65	PAFZZ	5905-00-106-9351	RC20GF273J	81349	RESISTOR, FIXED, COMPOSITION	EA	1
77	66	PAFZZ		186P10401S12	56289	CAPACITOR, FIXED, ELECTROLYTIC	EA	1
77	67	PAFZZ		186P47301S12	56289	CAPACITOR, FIXED, ELECTROLYTIC	EA	2
77	68	PAFZZ	5905-00-111-4732	RC20GF125J	81349	RESISTOR, FIXED, COMPOSITION	EA	1
77	69	PAFZZ	5905-00-141-5393	RC20GF224J	81349	RESISTOR, FIXED, COMPOSITION	EA	1
77	70	PAFZZ	5905-00-104-8335	RC20GF124J	81349	RESISTOR, FIXED, COMPOSITION	EA	1
77	71	PAFZZ	5905-00-104-8333	RC20GF1B4J	81349	RESISTOR, FIXED, COMPOSITION	EA	1
77	72	PAFZZ		RV4NAYFD503A	81349	RESISTOR, VARIABLE	EA	2
77	73	PAFZZ	5910-00-666-8432	196P10404S11	56289	CAPACITOR, FIXED ELECTROLYTIC	EA	4
77	74	PAFZZ	5910-00-666-8433	196P10404S13	56289	CAPACITOR, FIXED, ELECTROLYTIC	EA	2
77	75	PAFZZ	5940-00-049-7836	SMB180449	80063	TERMINAL BOARD	EA	1
77	75A	PDFDD		SNC180448	80063	TERMINAL BOARD	EA	1
77	76	PAFZZ	5905-00-111-8357	RC20GF681J	81349	RESISTOR, FIXED, COMPOSITION	EA	1
77	77	PAFZZ	5905-00-141-1071	RC20GF474J	81349	RESISTOR, FIXED, COMPOSITION	EA	1
77	78	PAFZZ	5905-00-141-0591	RC20GF103J	81349	RESISTOR, FIXED, COMPOSITION	EA	1
77	79	PAFZZ	5905-00-114-5416	RC20GF274J	81349	RESISTOR, FIXED, COMPOSITION	EA	4
77	80	PAFZZ	5910-00-666-8433	196P10404513	56289	CAPACITOR, FIXED, ELECTROLYTIC	EA	1
77	81	PAFZZ	5905-00-141-0592	RC20GF122J	81349	RESISTOR, FIXED, COMPOSITION	EA	1
77	82	PAFZZ	5905-00-141-1116	RC20GF562J	81349	RESISTOR, FIXED, COMPOSITION	EA	1
77	83	PAFZZ	5930-00-548-6607	SMC180309	80063	SWITCH, ROTARY	EA	3
77	84	PAFZZ		RV3NAYF0503A	81349	RESISTOR VARIABLE	EA	1
77	85	PAFZZ	6210-00-186-7987	MS90287-4	96906	LAMPHOLDER	EA	1
77	86	PAFZZ	6210-00-169-4108	MS90287-6	96906	LAMPHOLDER	EA	1
77	87	PAFZZ	5940-00-092-1374	SMB180446	80063	TERMINAL BOARD	EA	1
77	87A	PDFDD		SMB180445	80063	TERMINAL BOARD	EA	1

REPAIR PARTS LIST

(1) ILLUSTRATION		(2)	(3)	(4)	(5)	(6)	(7)	(8)
(a) FIG NO.	(b) ITEM NO.	SMR CODE	NATIONAL STOCK NUMBER	PART NUMBER	FSCM	DESCRIPTION USABLE ON CODE	U/M	QTY INC IN UNIT
77	88	PAFZZ	5905-00-141-0592	RC20GF122J	81349	RESISTOR, FIXED, COMPOSITION	EA	1
77	89	PAFZZ	5905-00-114-5416	RC20GF274J	81349	RESISTOR, FIXED, COMPOSITION	EA	4
77	90	PAFZZ	5905-00-141-0591	RC20GF103J	81349	RESISTOR, FIXED, COMPOSITION	EA	1
77	91	PAFZZ	5905-00-141-1116	RC20GF562J	81349	RESISTOR, FIXED, COMPOSITION	EA	1
77	92	PAFZZ	5905-00-111-8357	RC20GF681J	81349	RESISTOR, FIXED, COMPOSITION	EA	1
77	93	PAFZZ	5930-00-309-3993	5MC180471	80063	SWITCH, ROTARY	EA	1
77	94	PAFZZ	5910-00-537-5472	E18D27	00656	CAPACITOR, FIXED, ELECTROLYTIC	EA	1
77	95	PAFZZ	5910-00-678-1623	CV1150	81349	CAPACITOR, VAR, CER, DIELECTRIC	EA	1
77	96	PAFZZ	5905-00-141-5393	RC20GF224J	81349	RESISTOR, FIXED, COMPOSITION	EA	2
77	97	XBFZZ		SMB180405	80063	TERMINAL BOARD	EA	1
77	97A	PDFDD		SMB180404	80063	TERMINAL BOARD	EA	1
77	98	PAFZZ	5905-00-104-8334	RC20GF331J	81349	RESISTOR, FIXED, COMPOSITION	EA	1
77	99	PAFZZ	5905-00-106-9345	RC20GF683J	81349	RESISTOR, FIXED, COMPOSITION	EA	1
77	100	PAFZZ	5905-00-141-0593	RC20GF182J	81349	RESISTOR, FIXED, COMPOSITION	EA	1
77	101	PAFZZ		CV11C450-2	81349	CAPACITOR, VAR, CER, DIELECTRIC	EA	1
77	102	PAFZZ		CM15E330J	81349	CAPACITOR, FXD, MICA, DIELECTRIC	EA	2
77	103	XBFZZ		SMB180408	80063	TERMINAL BOARD	EA	1
77	103A	XBFFF		SMB180407	80063	TERMINAL BOARD	EA	1
77	104	PAFZZ	5905-00-104-8334	RC20GF331J	81349	RESISTOR, FIXED, COMPOSITION	EA	1
77	105	PAFZZ	5905-00-106-9345	RC20GF683J	81349	RESISTOR, FIXED, COMPOSITION	EA	1
77	106	PAFZZ	5905-00-141-0593	RC20GF182J	81349	RESISTOR, FIXED, COMPOSITION	EA	1
77	107	PAFZZ	5940-00-092-1372	SMB180396	80063	TERMINAL BOARD	EA	1
77	107A	XDFFF		SMC180395	80063	TERMINAL BOARD	EA	1
77	108	PAFZZ		CM25E821GN3	81349	CAPACITOR, FXD, MICA, DIELECTRIC	EA	1
77	109	PAFZZ		CM15E511JN3	81349	CAPACITOR, FXD, MICA, DIELECTRIC	EA	1
77	110	PAFZZ		CM15E101JN3	81349	CAPACITOR, FXD, MICA, DIELECTRIC	EA	1
77	111	PAFZZ	5910-00-436-1064	186P10404S12	56289	CAPACITOR, FXD, MICA, DIELECTRIC	EA	1
77	112	PAFZZ	5905-00-116-8566	RC20GF680J	81349	RESISTOR, FIXED, COMPOSITION	EA	1
77	113	PAFZZ	5905-00-141-0596	RC20GF473J	81349	RESISTOR, FIXED, COMPOSITION	EA	2
77	114	PAFZZ	5905-00-252-1050	RC30GF393J	81349	RESISTOR, FIXED, COMPOSITION	EA	1
77	115	PAFZZ		CM15E820JN3	81349	CAPACITOR, FXD, MICA, DIELECTRIC	EA	1
77	116	PAFZZ	5910-00-725-7647	CM15C220J	81349	CAPACITOR, FXD, MICA, DIELECTRIC	EA	1
77	117	PAFZZ	5905-00-141-0596	RC20GF473J	81349	RESISTOR, FIXED, COMPOSITION	EA	2
77	118	PAFZZ		CM15E101J	81349	CAPACITOR, FXD, MICA, DIELECTRIC	EA	1
77	119	PAFZZ	5910-00-460-0847	CK068X104M	81349	CAPACITOR, FXD, CERAMIC	EA	1
77	120	PAFZZ	5905-00-104-8336	RC20GF104J	81349	RESISTOR, FIXED, COMPOSITION	EA	3
77	121	PAFZZ		1726-136	80503	CAPACITOR, VARIABLE	EA	1
77	122	PAFZZ		CM15F241G03	81349	CAPACITOR, FXD, MICA, DIELECTRIC	EA	1
77	123	PAFZZ	569006530-2667	RV4LAXSA252A	81349	RESISTOR, VARIABLE	EA	1
77	124	PAFZZ	5910-00-222-6127	SA9507	07886	CAPACITOR, VAR, CER, DIELECTRIC	EA	1
77	125	PAFZZ		CM15F621GP3	81349	CAPACITOR, FXD, MICA DIELECTRIC	EA	1

REPAIR PARTS LIST

(1) ILLUSTRATION		(2)	(3)	(4)	(5)	(6) DESCRIPTION	(7)	(8)
(a) FIG NO.	(b) ITEM NO.	SMR CODE	NATIONAL STOCK NUMBER	PART NUMBER	FSCM	USABLE ON CODE	U/M	QTY INC IN UNIT
77	126	PAFZZ		CM30E102GN1	81349	CAPACITOR, FXD, MICA DIELECTRIC	EA	1
77	127	PAFDD	5820-00-581-2601	SMD180327	80063	AFC UNIT ASSEMBLY	EA	1
77	127A	XBFZZ		SMD180433	81349	TERMINAL BOARD	EA	1
77	128	PAFZZ	5905-00-114-5438	RC20GF510J	81349	RESISTOR, FIXED, COMPOSITION	EA	1
77	129	PAFZZ		SBD22M0	81349	CONNECTOR, RECEPTACLE, ELECTRICAL	EA	1
77	130	PAFZZ		WCS9S STYLE N42	81349	CONNECTOR, PLUG, ELECTRICAL	EA	1
77	131	PAFZZ	5935-00-819-1133	MS3100E18-11P	81349	CONNECTOR, RECEPTACLE, ELECTRICAL	EA	1
77	132	PAFZZ		MS3116F14-5S	81349	CONNECTOR, PLUG, ELECTRICAL	EA	1
77	133	PAFZZ	5910-00-667-6613	CC35UJ151G	81349	CAPACITOR, FXD, CER, DIELECTRIC	EA	1
77	134	PAFZZ	5905-00-106-1282	RC20GF223J	81349	RESISTOR, FIXED, COMPOSITION	EA	1
77	135	XBFZZ		SMB180399	80063	TERNINAL BOARD	EA	1
77	135A	XDFFF		SMC180398	80063	TERMINAL, BOARD	EA	1
77	136	PAFZZ	5905-00-434-2023	RC42GF822J	81349	RESISTOR, FIXED, COMPOSITION	EA	1
77	137	PAFZZ	5905-00-935-8545	RC20GF183J	81349	RESISTOR, FIXED, COMPOSITION	EA	1
77	138	PAFZZ	5905-00-236-9858	RC42GF562J	81349	RESISTOR, FIXED, COMPOSITION	EA	1
77	139	PAFZZ	5905-00-935-8544	RC20GF181J	81349	RESISTOR, FIXED, COMPOSITION	EA	1
77	140	PAFZZ	5910-00-436-1064	186P10404512	56289	CAPACITOR, FIXED, ELECTROLYTIC	EA	1
77	141	PAFZZ	5905-00-141-0595	RC20GF472J	81349	RESISTOR, FIXED, COMPOSITION	EA	1
77	142	PAFZZ	5905-00-141-0596	RC20GF473J	81349	RESISTOR, FIXED, COMPOSITION	EA	1
77	143	XBFZZ		SMC180402	80063	TERMINAL, BOARD	EA	1
77	143A	XDFFF		SMC180401	80063	TERMINAL, BOARD,	EA	1
77	144	PAFZZ	5905-00-114-5489	RC20GF823J	81349	RESISTOR, FIXED, COMPOSITION	EA	3
77	145	PAFZZ	5905-00-141-0591	RC20GF103J	81349	RESISTOR, FIXED, COMPOSITION	EA	2
77	146	PAFZZ		RCR07G102JS	81349	RESISTOR, FIXED, COMPOSITION	EA	1
77	147	PAFZZ	5910-00-762-2945	CM15E471J	81349	CAPACITOR, FXD, MICA, DIELECTRIC	EA	2
77	148	PAFZZ	5905-00-141-0595	RC20GF472J	81349	RESISTOR, FIXED, COMPOSITION	EA	1
77	149	PAFZZ	5905-00-141-5393	RC20GF224J	81349	RESISTOR, FIXED, COMPOSITION	EA	1
77	150	PAFZZ	5940-00-092-1364	SMB180410	80063	TERMINAL BOARD	EA	1
77	150A	XDFFF		SMC180409	80063	TERMINAL BOARD	EA	1
77	151	PAFZZ	5905-00-108-6922	RC20GF151J	81349	RESISTOR, FIXED, COMPOSITION	EA	1
77	152	PAFZZ	5905-00-114-5489	RC20GF823J	81349	RESISTOR, FIXED, COMPOSITION	EA	1
77	153	PAFZZ	5905-00-104-8330	RC20GF333J	81349	RESISTOR, FIXED, COMPOSITION	EA	1
77	154	PAFZZ		CM15E331JN3	81349	CAPACITOR, FXD, MICA, DIELECTRIC	EA	1
77	155	PAFZZ	5910-00-436-1064	186P10404S12	56289	CAPACITOR, FXD, ELECTROLYTIC	EA	1
77	156	PAFZZ	5905-00-141-0595	RC20GF472J	81349	RESISTOR, FIXED, COMPOSITION	EA	4
77	156A	XBFZZ		SMD180343	80063	CHASSIS ASSEMBLY, RF	EA	1
77	157	PAFZZ	5905-00-104-8336	RC20GF104J	81349	RESISTOR, FIXED, COMPOSITION	EA	2
77	158	PAFZZ	5910-00-762-2945	CM15E471J	81349	CAPACITOR, FXD, MICA, DIELECTRIC	EA	1
77	159	PAFZZ		CM04FA331J03	81349	CAPACITOR, FXD, MICA, DIELECTRIC	EA	1
77	160	PAFZZ	5940-09-213-58	SMB180443	80063	TERMINAL BOARD	EA	1
77	160A	XDFFF		SMB180442	80063	TERMINAL BOARD	EA	1

REPAIR PARTS LIST

(1) ILLUSTRATION		(2)	(3)	(4)	(5)	(6)	(7)	(8)
(a) FIG NO.	(b) ITEM NO.	SMR CODE	NATIONAL STOCK NUMBER	PART NUMBER	FSCM	DESCRIPTION USABLE ON CODE	U/M	QTY INC IN UNIT
77	161	PAFZZ	5905-00-104-8336	RC20GF104J	81349	RESISTOR, FIXED, COMPOSITION	EA	2
77	161	PAFZZ	5905-00-104-8336	RC20GF310J	81349	RESISTOR, FIXED, COMPOSITION	EA	2
77	162	PAFZZ	5905-00-104-8348	RC20GF332J	81349	RESISTOR, FIXED, COMPOSITION	EA	2
77	163	PAFZZ	5910-00-436-1064	186P10404512	56289	CAPACITOR, FIXED, ELECTROLYTIC	EA	1
77	164	PAFZZ		CB850	04213	FILTER, 100KC	EA	2
77	165	PAFZZ		CM0CD100D03	56289	CAPACITOR, FXD, MICA DIELECTRIC	EA	1
77	166	PAFZZ	5910-00-436-1064	186P10404S12	56289	CAPACITOR, FXD, MICA DIELECTRIC	EA	1
77	167	PAFZZ	5905-00-141-0591	RC20GF103J	81349	RESISTOR, FIXED, COMPOSITION	EA	6
77	168	XBFZZ		SNC180434	80063	TERMINAL BOARD	EA	1
77	169	PAFZZ	5905-00-111-8372	RC32GF222J	81349	RESISTOR, FIXED, COMPOSITION	EA	2
77	170	PAFZZ	5905-00-683-2238	RCR07G103JS	81349	RESISTOR, FIXED, COMPOSITION	EA	1
77	171	PAFZZ	5905-00-104-8330	RC20GCF333J	81349	RESISTOR, FIXED, COMPOSITION	EA	2
77	172	PAFZZ	5905-00-141-5393	RC20GF224J	81349	RESISTOR, FIXED, COMPOSITION	EA	12
77	173	PAFZZ	5905-00-114-5489	RC20GF823J	81349	RESISTOR, FIXED, COMPOSITION	EA	2
77	174	PAFZZ	5905-00-254-7096	RC42GF823J	81349	RESISTOR, FIXED, COMPOSITION	EA	2
77	175	PAFZZ	5905-00-106-9344	RC20GF101J	81349	RESISTOR, FIXED, COMPOSITION	EA	2
77	176	PAFZZ	5910-00-060-9619	CM15E511J	81349	CAPACITOR, FXD, MICA DIELECTRIC	EA	6
77	177	XBFZZ		SMD180300-2	80063	JACK, TELEPHONE	EA	1
77	178	PAFZZ	5910-00-762-2945	CM15E471J	81349	CAPACITOR, FXD, MICA, DIELECTRIC	EA	2
77	179	PAFZZ	5930-00-092-1295	SMC180308	80063	SWITCH, ROTORY	EA	1
77	180	PAFZZ		11X574	96906	RELAY	EA	1
77	181	PAFZZ	5906-00-577-9987	RV4LAXSA254A	81349	RESISTOR, VARIABLE	EA	1
77	182	XBFZZ		SMC180437	80063	TERMINAL BOARD	EA	1
77	182A	XBFZZ		SMC180436	80063	TERMINAL BOARD	EA	1
77	183	PAFZZ	5905-00-135-6046	RCR07G681JS	81349	RESISTOR, FIXED, COMPOSITION	EA	1
77	184	PAFZZ		RCR07G682JS	81349	RESISTOR, FIXED, COMPOSITION	EA	1
77	185	PAFZZ	5905-00-104-8346	RC20GF334J	81349	RESISTOR, FIXED, COMPOSITION	EA	2
77	186	PAFZZ	5905-00-279-1740	RCR32G180JS	81349	RESISTOR, FIXED, COMPOSITION	EA	1
77	187	PAFZZ	5905-00-141-1071	RC20GF474J	81349	RESISTOR, FIXED, COMPOSITION	EA	3
77	188	PAFZZ	5905-00-141-5393	RC20GF224J	81349	RESISTOR, FIXED, COMPOSITION	EA	10
77	189	PAFZZ	5905-00-683-2235	RCR07G680JS	81349	RESISTOR, FIXED, COMPOSITION	EA	1
77	190	PAFZZ	5905-00-114-0711	RC07GF472J	81349	RESISTOR, FIXED, COMPOSITION	EA	1
77	191	PAFZZ	5905-00-114-5489	RC20GFB23J	81349	RESISTOR, FIXED, COMPOSITION	EA	2
77	192	PAFZZ	5905-00-683-7721	RCR076101JS	81349	RESISTOR, FIXED, COMPOSITION	EA	1
77	193	PAFZZ	5905-00-106-1356	RC07GF152J	81349	RESISTOR, FIXED, COMPOSITION	EA	1
77	194	PAFZZ	5905-00-114-5344	RCR07G184JS	81349	RESISTOR, FIXED, COMPOSITION	EA	1
77	195	PAFZZ	5905-00-115-3560	RCR07G183JS	81349	RESISTOR, FIXED, COMPOSITION	EA	1
77	196	PAFZZ	5905-00-141-0598	RC20GF561J	81349	RESISTOR, FIXED, COMPOSITION	EA	1
77	197	PAFZZ	5905-00-141-0595	RC20GF472J	81349	RESISTOR, FIXED, COMPOSITION	EA	2
77	198	PAFZZ	5905-00-106-9348	RC20GF154J	81349	RESISTOR, FIXED, COMPOSITION	EA	1

REPAIR PARTS LIST

(1) ILLUSTRATION		(2)	(3)	(4)	(5)	(6) DESCRIPTION	(7)	(8)
(a) FIG NO.	(b) ITEM NO.	SMR CODE	NATIONAL STOCK NUMBER	PART NUMBER	FSCM	USABLE ON CODE	U/M	QTY INC IN UNIT
77	199	PAFZZ	5905-00-111-4738	RC20GF152J	81349	RESISTOR, FIXED, COMPOSITION	EA	1
77	200	PAFZZ	5905-00-104-8336	RC20GF104J	81349	RESISTOR, FIXED, COMPOSITION	EA	1
77	201	PAFZZ		186P1040S12	56289	CAPACITOR, FIXEDELECTROLYTIC	EA	2
77	202	PAFZZ		CM15E331J	81349	CAPACITOR, FXD, MICA DIELECTRIC	EA	2
77	203	PAFZZ		186P10401S12	56289	CAPACITOR, FIXED, ELECTROLYTIC	EA	1
77	204	PAFZZ		CB851	04213	COIL ASSEMBLY	EA	1
77	205	XBFZZ		SMB180458	80063	TERMINAL BOARD	EA	1
77	205A	XDFFF		SMB180457	80063	TERMINAL BOARD	EA	1
77	206	PAFZZ	5905-00-257-0926	RC42GF332J	81349	RESISTOR, FIXED, COMPOSITION	EA	4
77	207	XBFZZ		SMB180422	80063	TERMINAL BOARD	EA	1
77	207A	XDFFF		SMB180421	80063	TERMINAL BOARD	EA	1
77	208	PAFZZ	5905-00-141-0595	RC20GF472J	81349	RESISTOR, FIXED, COMPOSITION	EA	1
77	209	PAFZZ	5905-00-141-5393	RC20GF224J	81349	RESISTOR, FIXED, COMPOSITION	EA	6
77	210	PAFZZ	5905-00-106-9345	RC20GF683J	81349	RESISTOR, FIXED, COMPOSITION	EA	1
77	211	PAFZZ	5905-00-114-5489	RC20GF823J	81349	RESISTOR, FIXED, COMPOSITION	EA	2
77	212	PAFZZ	5905-00-104-8335	RC20GF124J	81349	RESISTOR, FIXED, COMPOSITION	EA	1
77	213	PAFZZ	5930-00-096-7326	SMB180431	80063	TERMINAL BOARD	EA	1
77	213A	XDFFF		SMB180430	80063	TERMINAL BOARD	EA	1
77	214	PAFZZ	5905-00-141-0591	RC20GF103J	81349	RESISTOR, FIXED, COMPOSITION	EA	2
77	215	PAFZZ	5905-00-141-0596	RC20GF473J	81349	RESISTOR, FIXED, COMPOSITION	EA	4
77	216	PAFZZ		CM15E5115	81349	CAPACITOR, FXD, MICA DIELECTRIC	EA	6
77	217	PAFZZ	5910-00-850-0540	CM15E500J	81349	CAPACITOR, FXD, MICA DIELECTRIC	EA	1
77	218	PAFZZ	5910-00-850-0540	CM15E500J	81349	CAPACITOR, FXD, MICA DIELECTRIC	EA	1
77	219	XBFZZ		SMB180428	80063	TERMINAL BOARD	EA	1
77	219A	XDFFF		SMC180427	80063	TERMINAL BOARD	EA	1
77	220	PAFZZ	5905-00-104-8348	RC20GF332J	81349	RESISTOR, FIXED, COMPOSITION	EA	3
77	221	PAFZZ	5905-00-111-4738	RC20GF152J	81349	RESISTOR, FIXED, COMPOSITION	EA	2
77	222	PAFZZ	5905-00-116-8566	RC20GF680J	81349	RESISTOR, FIXED, COMPOSITION	EA	1
77	223	PAFZZ		186P10401S12	56289	CAPACITOR, FIXED, ELECTROLYTIC	EA	1
77	224	PAFZZ	5910-00-060-9619	CM15E511J	81349	CAPACITOR, FXD, MICA, DIELECTRIC	EA	2
78	1	PAFZZ		CM15E430J	81349	CAPACITOR, FXD, MICA, DIELECTRIC	EA	1
78	2	PAFZZ	5905-00-141-1071	RC20GF474J	81349	RESISTER, FXD, COMPOSITION	EA	1
78	3	PAFZZ	5905-00-141-5393	RC20GF224J	81349	RESISTER, FXD, COMPOSITION	EA	2
78	4	PAFZZ	5905-00-110-0196	RC20GF102J	81349	RESISTER, FIXED, COMPOSITION	EA	1
78	5	PAFZZ	5910-00-060-9619	CM15E511J	81349	CAPACITOR, FXD, MICA, DIELECTRIC	EA	1
78	6	PAFZZ		CM15C200J	81349	CAPACITOR, FXD, MICA, DIELECTRIC	EA	1
78	7	PAFZZ		MAPC50	80503	CAPACITOR, VARIABLE, DIELECTRIC	EA	1
78	8	PAFZZ		CM15E680J	81349	CAPACITOR, FXD, MICA, DIELECTRIC	EA	1
78	9	PAFZZ	5905-00-114-5489	RC20GF823J	81349	RESISTER, FXD, COMPOSITION	EA	1
78	10	PAFZZ	5905-00-141-1168	RC20GF222J	81349	RESISTER, FXD, COMPOSITION	EA	1

REPAIR PARTS LIST

(1) ILLUSTRATION		(2)	(3)	(4)	(5)	(6)	(7)	(8)
(a) FIG NO.	(b) ITEM NO.	SMR CODE	NATIONAL STOCK NUMBER	PART NUMBER	FSCM	DESCRIPTION USABLE ON CODE	U/M	QTY INC IN UNIT
78	11	PAFZZ	5910-00-901-8949	CM15E300J	81349	CAPACITOR, FXD, MICA, DIELECTRIC	EA	1
78	12	PAFZZ	5935-00-222-9828	TS103P01	81349	SOCKET, ELECTRICAL TUBE	EA	1
78	13	PAFZZ	5935-00-201-4783	TS101P01	81349	SOCKET, ELECTRICAL TUBE	EA	1
79	1	PAFZZ	5905-00-141-0591	RC20GF103J	81349	RESISTOR, FIXED, COMPOSITION	EA	1
79	2	PAFZZ	5930-00-548-8634	SMC180307	80063	SWITCH, ROTORY	EA	2
79	3	PAFZZ	5305-00-548-6607	SMC180309	80063	SWITCH, ROTORY	EA	4
79	4	PAFZZ	5905-00-104-8334	RC20GF331J	81349	RESISTOR, FIXED, COMPOSITION	EA	1
79	5	PAFZZ	5905-00-141-0592	RC20GF122J	81349	RESISTOR, FIXED, COMPOSITION	EA	1
79	6	PAFZZ	5905-00-110-0993	RC20GF123J	81349	RESISTOR, FIXED, COMPOSITION	EA	1
79	7	PAFZZ	5905-00-114-5425	RC20GF362J	81349	RESISTOR, FIXED, COMPOSITION	EA	1
79	8	PAFZZ	6625-00-783-5145	SMC283217	80063	METER.VU	EA	1
79	9	PAFZZ		MR13S100DCUAR	81349	AMMETER	EA	1
79	10	PAFZZ	5930-00-092-1295	SMC180308	80063	SWITCH, ROTORY	EA	1
79	11	PAFZZ		MS90287-6	96906	LAMPHOLDER	EA	1
79	12	PAFZZ	62104-0-186-7987	MS90287-4	96906	LAMPHOLDER	EA	1
79	13	PAFZZ		SMB180306	80063	RESISTOR, VARIABLE	EA	1
79	14	XBFZZ		SMD180300-2	80063	JACK, TELEPHONE	EA	1
79	15	PAFZZ		CM15E511JP3	81349	CAPACITOR, FXD, MICA DIELECTRIC	EA	1
79	16	PAFZZ	5905-00-174-4958	SMB180305	80063	RESISTOR, VARIABLE	EA	1
79	17	PAFZZ	5910-00-222-6127	SA9507	07886	CAPACITOR, VAR, CER, DIELECTRIC	EA	1
79	18	PAFZZ		CM15F621GP3	81349	CAPACITOR.FXD, MICA DIELECTRIC	EA	1
79	19	PAFZZ	5935-00-919-5835	M21097-1-172	81349	CONNECTOR, RECEPTACLE ELECTRICAL	EA	1
79	20	PAFZZ	5935-00-853-7596	MS35179-1094A	96906	CONNECTOR, RECEPTACLE ELECTRICAL	EA	1
79	21	PAFZZ	5820-00-581-2601	SMD180327	80063	AFC UNIT ASSEMBLY	EA	1
79	22	PAFZZ	5820-00-537-2306	SMD180310	80063	DR ASSEMBLY, VERNIER	EA	1
79	23	XDFFF		SMB180323	80063	PLANET ASSEMBLY	EA	1
80	1	PAFZZ		5418	03040	FILTER	EA	1
80	2	XBFZZ		SMB180241	80063	TERMINAL BOARD	EA	1
80	2A	XBFZZ		SMB180240	80063	TERMINAL BOARD	EA	1
80	3	PAFZZ	5905-00-141-0598	RC20GF561J	81349	RESISTOR, FIXED COMPOSITION	EA	2
80	4	PAFZZ		M2555	21937	TRANSFORMER	EA	2
80	5	PAFZZ		451A	03040	FILTER	EA	1
80	6	PAFZZ		186P47301512	56289	CAPACITOR, FXD, ELECTROLYTIC	EA	4
80	7	PAFZZ		541C	03040	FILTER	EA	1
80	8	XBFZZ		SMB180229	80063	TERMINAL BOARD	EA	1
80	8A	XBFZZ		SMB180228	80063	TERMINAL BOARD	EA	1
80	9	PAFZZ	5910-00-227-0796	CM15C050K	72136	CAPACITOR, FXD, MICA, DIELECTRIC	EA	1
80	10	PAFZZ	5910-00-643-8713	CM15C120J	72136	CAPACITOR, FXD, MICA, DIELECTRIC	EA	1
80	11	PAFZZ	5905-00-114-5430	RC20GF433J	81349	RESISTOR, FIXED COMPOSITION	EA	1
80	12	PAFZZ	5905-00-106-9351	RC20GF273J	81349	RESISTOR, FIXED COMPOSITION	EA	1

REPAIR PARTS LIST

(1) ILLUSTRATION		(2)	(3)	(4)	(5)	(6) DESCRIPTION	(7)	(8)
(a) FIG NO.	(b) ITEM NO.	SMR CODE	NATIONAL STOCK NUMBER	PART NUMBER	FSCM	USABLE ON CODE	U/M	QTY INC IN UNIT
80	13	XBFZZ		SMB180238	80063	TERMINAL BOARD	EA	1
80	13A	XBFZZ		SMB180237	80063	TERMINAL BOARD	EA	1
80	14	PAFZZ	5905-00-111-4858	RC20GF471J	81349	RESISTOR, FIXED COMPOSITION	EA	4
80	15	PAFZZ	5905-00-111-4742	RC20GF391J	81349	RESISTOR, FIXED COMPOSITION	EA	2
80	16	XBFZZ		SMB180226	80063	TERMINALBOARD	EA	1
80	16A	XBFZZ		SMB180225	80063	TERMINAL BOARD	EA	1
80	17	PAFZZ	5905-00-141-5393	RC20GF224J	81349	RESISTOR, FIXED COMPOSITION	EA	1
80	18	PAFZZ	5905-00-106-9345	RC20GF683J	81349	RESISTOR, FIXED COMPOSITION	EA	1
80	19	XBFZZ		SMB180232	80063	TERMINAL BOARD	EA	1
80	19A	XBFZZ		SMB180231	80063	TERMINAL BOARD	EA	1
80	20	PAFZZ	5905-00-111-4858	RC20GF471J	81349	RESISTOR, FIXED, COMPOSITION	EA	4
80	21	PAFZZ	5905-00-111-4742	RC20GF391J	81349	RESISTOR, FIXED, COMPOSITION	EA	2
80	22	PAFZZ	5905-00-247-8700	RC30GF124J	81349	RESISTOR, FIXED, COMPOSITION	EA	1
80	23	PAFZ	5905-00-252-1050	RC30GF393J	81349	RESISTOR, FIXED, COMPOSITION	EA	1
80	24	PAFZZ	5905-00-501-5184	RV4LAYS5A503A	81349	RESISTOR, VARIABLE	EA	1
80	25	PAFZZ	5910-00-721-3804	CE41C2500	81349	CAPACITOR, FIXED, ELECTROLYTIC	EA	2
80	26	XBFZZ		SMB180235	80063	TERMINAL BOARD	EA	1
80	26	XBFZZ		SMB180234	80063	TERMINAL BOARD	EA	1
80	27	PAFZZ	5905-00-141-0598	RC20GF561J	81349	RESISTOR, FIXED COMPOSITION	EA	2
81	1	PAFZZ		541C	03040	FILTER	EA	1
81	2	PAFZZ		451A	03040	FILTER	EA	1
81	3	PAFZZ		5418	03040	FILTER	EA	1
81	4	PAFZZ	5910-00-726-5228	196P10406511	56289	CAPACITOR, FIXED, ELECTROLYTIC	EA	1
81	5	PAFZZ	5910-00-161-1635	CP70B1EF405K	81349	CAPACITOR, FXD, PPR., DIELECTRIC	EA	1
81	6	PAFZZ	5910-00-787-5074	CP70BGEF245K	81349	CAPACITOR, FXD, PPR., DIELECTRIC	EA	2
81	7	PAFZZ	5930-00-655-1508	ST22N	81349	SWITCH, TOGGLE	EA	1
81	8	PAFZZ	5905-00-814-1520	RW34G502	81349	RESISTOR, FIXED, WIREWOUND	EA	1
81	9	PAFZZ	5910-00-721-3804	CE41C250Q	81349	CAPACITOR, FIXED, ELECTROLYTIC	EA	2
81	10	PAFZZ		TS3B5	85008	FILTER, CHOKE	EA	1
81	11	PAFZZ	6210-00-553-7437	MS90287-3	96906	LAMPHOLDER	90	1
81	12	PAFZZ	5905-0-501-5184	RV4LAYS5A503A	81349	RESISTOR, VARIXBLE	EA	1
81	13	PAFZZ		3263SMG4LC	74193	CIRCUIT BREAKER	EA	1
81	14	PAFZZ		T5384	85008	FILTERCHOKE	EA	1
81	15	PAFZZ		P2553	21937	TRANSFORMER	EA	1
82	1	PAFZZ		SM1B397007	80063	TERMINAL BOARD	EA	1
82	2	PAFZZ	5960-00-027-1732	5R4WGY	81349	ELECTRON, TUBE	EA	2
82	21	PDFDD		M1B0201	80063	POWER SUPPLY SUBASSEMBLY	EA	1
82	3	PAFZZ	5960-00-179-3252	6080	81349	ELECTRON, TUBE	EA	1
82	4	PAFZZ	5960-00-262-0286	5651	81349	ELECTRON, TUBE	EA	1
82	5	PAFZZ	5960-00-179-3710	6AU6	81349	ELECTRON, TUBE	EA	1
82	6	PAFZZ		0A2	81349	ELECTRON, TUBE	EA	1

REPAIR PARTS LIST

(1) ILLUSTRATION		(2)	(3)	(4)	(5)	(6)	(7)	(8)
(a) FIG NO.	(b) ITEM NO.	SMR CODE	NATIONAL STOCK NUMBER	PART NUMBER	FSCM	DESCRIPTION USABLE ON CODE	U/M	QTY INC IN UNIT
82	7	PAFZZ		6X4W	81349	ELECTRON, TUBE	EA	1
82	8	PAFZZ	5935-00-201-4783	TS101P01	81349	SOCKET, ELECTRICAL TUBE	EA	3
82	9	PAFZZ	5936-00-222-9828	TS102P01	81349	SOCKET, ELECTRICAL, TUBE	EA	4
82	10	PAFZZ		RC42GF333J	81349	RESISTOR, FIXED, COMPOSITION	EA	1
82	11	PAFZZ	5905-00-254-7101	RC42GF104J	81349	RESISTOR, FIXED, COMPOSITION	EA	1
82	12	XBFZZ		SMB180189	80063	TERMINAL BOARD	EA	1
82	12A	XBFZZ		SMB180188	80063	TERMINAL BOARD	EA	1
82	13	PAFZZ	5905-00-116-8566	RC20GF680J	81349	RESISTOR, FIXED, COMPOSITION	EA	2
82	14	PAFZZ	5905-00-104-5756	RC20GF105J	81349	RESISTOR, FIXED, COMPOSITION	EA	1
82	15	PAFZZ	5905-00-279-2302	RC42GF560J	81349	RESISTOR, FIXED, COMPOSITION	EA	2
82	16	PAFZZ		RC42GF124J	81349	RESISTOR, FIXED, COMPOSITION	EA	1
82	17	XBFZZ		SMD180183	80063	CHASSIS ASSEMBLY, POWER	EA	1
83	1	PAFZZ		RV4LAYS252A	81349	RESISTOR, VARIABLE	EA	2
83	2	PAFZZ	5905-00-518-5593	RV4LAYS504A	81349	RESISTOR, VARIABLE	EA	2
83	3	XBFZZ		SMC180291	80063	COVER ASSEMBLY, OSCILLATOR	EA	1
83	4	PAFZZ		RV4LAYS103A	81349	RESISTOR, VARIABLE	EA	2
83	5	XBFZZ	5940-00-983-6084	6-141	71785	TERMINAL STRIP	EA	2
83	6	PAFZZ	5905-00-646-5958	RV4LAYS102A	81349	RESISTOR, VARIABLE	EA	1
83	7	PAFZZ	5905-00-232-2983	RVNAYS102A	81349	RESISTOR, VARIABLE	EA	1
83	8	XBFZZ	5940-00-983-6127	6-141Y	71785	TERMINAL STRIP	EA	1
83	9	PAFZZ	5935-00-644-5121	6808	74545	CONNECTOR, PLUG, ELECTRICAL	EA	1
83	10	PAFZZ		ST22	81349	SWITCH, TOGGLE	EA	1
83	11	XBFZZ	5940-00-983-6127	6-141Y	71785	TERMINAL STRIP	EA	1
83	12	PAFZZ	5930-00-299-7815	UG290U	81349	CONNECTOR, RECEPTACLE, ELECTRIC	EA	1
83	13	PAFZZ	5910-00-556-9440	CV11A070	81349	CAPACITOR, VAR, CER, DIELECTRIC	EA	1
83	14	PAFZZ	5935-00-283-7096	14634	71785	CONNECTOR, PLUG, ELECTRICAL	EA	1
84	1	XBFZZ		SMD180512	80063	COVER	EA	1
84	2	PDFFD		SMC10502	80063	FAN AXIAL	EA	1
84	3	PAFZZ	5910-00-667-5249	CP53B1FE504V	81349	CAPACITOR, FXD, PPR, DIELECTRIC	EA	1
84	4	PAFZZ		SMD180166-4	80063	KEY, HEXAGON, ALLEN	EA	1
84	5	PAFZZ		SMD180166-5	80063	KEY, HEXAGON, ALLEN	EA	1
84	6	PAFZZ		SMD180166-2	80063	KEY, HEXAGON, ALLEN	EA	1
84	7	PAFZZ		SMD180166-3	80063	KEY, HEXAGON, ALLEN	EA	1
84	8	PAFZZ	5120-00-681-5500	SMD180516	80063	TOOL ASSEMBLY, ALIGN	EA	1
84	9	PAFZZ		14633	71785	CONNECTOR, PLUG, ELECTRICAL	EA	1
84	10	PAFZZ	4140-00-093-7679	0-429-4	60399	FAN BLADE	EA	1
84	11	PAFZZ	6105-00-567-2793	NBCK15-7	02598	MOTOR, AC	EA	1

REPAIR PARTS LIST

(1) ILLUSTRATION		(2)	(3)	(4)	(5)	(6) DESCRIPTION	(7)	(8)
(a) FIG NO.	(b) ITEM NO.	SMR CODE	NATIONAL STOCK NUMBER	PART NUMBER	FSCM	USABLE ON CODE	U/M	QTY INC IN UNIT
						GROUP 090506020401 AFC UNIT ASSEMBLY SMD180327		
85	1	PAFZZ		MS35120	96906	CONNECTOR, RECEPTACLE, ELEC	EA	1
85	1A	PAFZZ	5820-00-581-2601	SMD180327	80063	AFC UNIT ASSEMBLY	EA	1
85	2	PAFZZ	5935-00-280-2017	M7PLRN	81312	CONNECTOR, PLUG, ELECTRICAL	EA	1
85	3	XBFZZ		SMC108889	80063	COVER, DUST, AFC	EA	1
85	4	PAFZZ	6105-00-537-5971	SMC108895	80063	MOTOR ACTUATOR	EA	1
85	5	PAFZZ	5930-00-646-4619	1SM1	91929	SWITCH, TOGGLE	EA	1
85	6	XBFZZ		SMB108888	80063	RETAINER CAPACITOR	EA	1
85	7	PAFZZ	5910-00-222-6127	SA9507	07886	CAPACITOR, VAR, CER, DIELECTRIC	EA	1
85	8	PAFZZ	3010-00-203-1630	SMB180329	80063	COUPLING, FLEXIBLE	EA	1
85	9	XBFZZ		SMD108908	80063	HOUSING ASSEMBLY	EA	1
85	10	XBFZZ		SMD180328	80063	GEAR TRAIN ASSEMBLY	EA	1
85	11	XBFZZ		SMB180332	80063	GEAR 5 ASSEMBLY	EA	1
85	12	XBFZZ		SMB180335	80063	GEAR 6 ASSEMBLY	EA	1
85	13	XBFZZ		SMC180337	80063	DRIVE SHAFT, CAPACITOR	EA	1
85	14	PAFZZ	8515-00-702-0733	SMB108896	80063	WINDOW, DISC	EA	1
85	15	PAFZZ	5815-00-511-4293	SMB108893	80063	DISC, SPINNER	EA	1
85	16	XBFZZ		SMB108905	80063	GEAR, SPUR	EA	1
85	17	PAFZZ	5930-00-296-9610	JS5	91929	ACTUATOR, SWITCH	EA	1
85	18	PAFZZ		SMC180330	80063	CAM, ACTUATOR, SWITCH	EA	1
86	1	PAFZZ		OSC86-1	82679	100KHZ OSC.MODIFICATION	EA	1
86	2	PAFZZ		OSC86-2	82679	555KHZ OSC.MODIFICATION	EA	1
86	3	PAFZZ	5935-00-722-7845	M21097-1-163	81349	CONNECTOR, RECEPTACLE, ELECTRICAL	EA	1
86	4	PAFZZ	5935-00-086-2368	NS3110E14-5P	81349	CONNECTOR, RECEPTACLE, ELECTRICAL	EA	2

REPAIR PARTS LIST

(1) ILLUSTRATION		(2)	(3)	(4)	(5)	(6) DESCRIPTION	(7)	(8)
(a) FIG NO.	(b) ITEM NO.	SMR CODE	NATIONAL STOCK NUMBER	PART NUMBER	FSCM	USABLE ON CODE	U/M	QTY INC IN UNIT
						GROUP 090507 Modification, 100 & 500 kHz Oscillators.		
87	1	XBFZZ		CA1727	82679	CABLE, DC	EA	1
87	2	XBFZZ		CA480-174-42	82679	CABLE ASSY, RF	EA	1
87	3	PAFZZ		0805024X5V00103H	18796	CAP, FXD, CER	EA	2
87	4	XBFZZ	5940-00-204-8023	3A1A	71279	TERM, TURRET	EA	2
87	5	PAFZZ	5945-00-236-4708	WKJ06026-5VdC	02288	RELAY, ARMATURE	EA	1
87	6	PAFZZ	5905-00-681-8957	RC07GF474J	81349	RES, FXD, COMP	EA	1
88	1	XBFZZ		CA480-174-42	82679	CABLE ASSY, RF	EA	1
88	2	XBFZZ		3A1A1	71279	TERM, TURRET	EA	2
88	3	PAFZZ		0805024X5V00103H	18796	CAP, FXD, CER	EA	2
88	4	XBFZZ		AN931A3-5	06540	GROMMET, RUBBER	EA	1
88	5	PAFZZ		WKJ06D26-5VDC	02288	RELAY, ARMATURE	EA	1
88	6	XBFZZ		MS6459	82679	BRKT, MTG, RELAY	EA	1
						GROUP 1001 PANEL, VOLUME AND CURRENT LEVEL INDICATOR		
89	1	PAFZZ	5340-00-810-5570	SOMES55	88947	AMMETER, PANEL, DC	EA	1
89	2	PAFZZ		SMB180228	80063	TERMINAL BOARD	EA	1
89	3	PAFZZ	6625-00-059-8704	SOMES55VU	88947	NETER, AUDIO LEVEL	EA	1
						GROUP 1002 BLACK PATCH PANEL		
90	1	PAFZZ	5935-00-815-4721	MT332C	82389	JACK, TELEPHONE	EA	52
90	2	PAFZZ	5935-00-192-4808	SMB47610	81351	JACK, TELEPHONE	EA	52
90	3	PAFZZ	5935-00-194-3079	JJ042	81349	JACK, TELEPHONE	EA	22
						GROUP 1003 AUDIO-DC PATCH PANEL		
91	1	PAFZZ	5905-00-666-2556	FR20	24681	RESISTOR, FIXED, COMPOSITION	EA	2
91	2	PAFZZ	5905-00-279-2629	RC32GF621J	81349	RESISTOR, FIXED, COMPOSITION	EA	1

REPAIR PARTS LIST

(1) ILLUSTRATION		(2)	(3)	(4)	(5)	(6) DESCRIPTION	(7)	(8)
(a) FIG NO.	(b) ITEM NO.	SMR CODE	NATIONAL STOCK NUMBER	PART NUMBER	FSCM	USABLE ON CODE	U/M	QTY INC IN UNIT
91	3	PAFZZ	5905-00-279-2545	RC32GF301J	81349	RESISTOR, FIXED, COMPOSITION	EA	2
91	4	PAFZZ	5905-00-279-2547	RC32GF431J	81349	RESISTOR, FIXED, COMPOSITION	EA	1
91	5	PAFZZ	5905-00-299-2051	RC32GF471J	81349	RESISTOR, FIXED, COMPOSITION	EA	1
91	6	PAFZZ	5905-00-279-2656	RC32GF511J	81349	RESISTOR, FIXED, COMPOSITION	EA	1
91	7	PAFZZ	5905-00-279-1726	RC32GF121J	81349	RESISTOR, FIXED, COMPOSITION	EA	1
91	8	PAFZZ	5905-00-299-2052	RC32GF561J	81349	RESISTOR, FIXED, COMPOSITION	EA	2
91	9	PAFZZ	5905-00-279-1691	RC32GF120J	81349	RESISTOR, FIXED, COMPOSITION	EA	1
91	10	PAFZZ	5995-00-570-5688	PJ22	70674	CABLE ASSY, TELEPHONE	EA	6
91	11	PAFZZ	5995-00-725-5484	PJ52	70674	PATCH CORD	EA	1
91	12	PAFZZ	5905-00-299-2059	RC32GF332J	81349	RESISTOR, FIXED, COMPOSITION	EA	4
91	13	PAFZZ	5935-00-815-4721	MT332C	82389	JACK, TELEPHONE	EA	23
91	14	PAFZZ	5935-00-201-3181	PJ1	70674	PLUG, TELEPHONE	EA	52
91	15	PAFZZ	5935-00-192-4812	PJ318	70674	JACK, TELEPHONE	EA	52
						GROUP 1004 TONE KEYS SHELF, TYPE 221, MODEL 1		
92	1	PAFZZ	5935-00-646-5890	26-4201-8S	02660	CONNECTOR, PLUG ELECTRICAL	EA	1
92	2	PAFZZ	5935-00-283-3826	MS16108-3	96906	JACK, TIP	EA	1
92	3	PAFZZ	5935-00-552-7978	5720140	02660	CONNECTOR, PLUG ELECTRICAL	EA	17
92	4	PAFZZ	5935-00-129-9358	TS101P02	81349	SOCKET, ELECTRON TUBE	EA	1
92	5	PAFZZ	5945-00-852-0465	KRP5D	77342	RELAY ARMATURE	EA	1
92	6	PAFZZ	5805-00-871-0155	693	88183	ISOLATION SUB-ASSY	EA	1
92	7	PAFZZ	5935-00-553-3181	57-10140	02660	CONNECTOR, PLUG ELECTRICAL	EA	1
92	8	PAFZZ	5950-00-854-0494	NRC234	74130	TRANSFORMER, AUDIOFREQUENCY	EA	1
92	9	PAFZZ	5905-00-279-2522	RC07GF154J	81349	RESISTOR, FIXED, COMPOSITION	EA	1
92	10	PAFZZ	5905-00-851-4199	T600	90303	ATTENUATOR, VARIABLE	EA	1
92	11	PAFZZ	5935-00-636-7145	UP121M	96906	CONNECTOR, PLUG ELECTRICAL	EA	1
92	12	PAFZZ	5935-00-857-6547	S202CCT	07233	CONNECTOR, PLUG ELECTRICAL	EA	1
92	13	PAFZZ	5920-00-199-9498	F02GR5008	81349	FUSE, CARTRIDGE	EA	2
92	14	PAFZZ	6240-00-223-9100	NE51	24455	LAMP, GLOW	EA	1
92	15	PAFZZ	6210-00-851-6307	26408-1137	26408	LIGHT, INDICATOR	EA	1
92	16	PAFZZ	5930-00-655-1582	MS35059	96906	SWITCH, TOGGLE	EA	1
92	17	PAFZZ	5805-00-862-2743	221MODEL1	74130	FREQUENCY SHIFT TONE KEYS	EA	1
92	18	PAFZZ	5920-00-553-7116	HKLX	71400	FUSEHOLDER	EA	2
						GROUP 100402 EXTENSION ADAPTER A1/750 AND 761		
93	1	PAFZZ	5805-00-863-3867	751	88183	ADAPTER, EXTENSION	EA	2
93	2	PAOZZ	5805-00-863-3668	750	88183	ADAPTER EXTENSION	EA	1
93	3	PAFZZ	5305-00-861-7247	7-0332	88183	THUMBSCREW	EA	2
93	4	PAFZZ	5935-00-553-3181	57-10140	02660	CONNECTOR, RECEPT, ELECTRICAL	EA	1

REPAIR PARTS LIST

(1) ILLUSTRATION		(2)	(3)	(4)	(5)	(6) DESCRIPTION	(7)	(8)
(a) FIG NO.	(b) ITEM NO.	SMR CODE	NATIONAL STOCK NUMBER	PART NUMBER	FSCM	USABLE ON CODE	U/M	QTY INC IN UNIT
93	5	PAFZZ	5935-00-553-3181	57-10140	02660	CONNECTOR, RECEP, ELECTRICAL	EA	1
93	6	PAFZZ	5936-00-662-7978	57-20140	02660	CONNECTOR, RECEP, ELECTRICAL	EA	1
						GROUP 100404 TELEPHONE LINE ISOLATION UNIT Z1		
94	1	PAFZZ		SMB180228	82679	TERMINAL BOARD	EA	1
94	2	PAFZZ	5305-00-871-0155	693	88183	TELEPHONE LINE ISOLATION UNIT	EA	1
94	3	PAFZZ	5905-00-851-4199	T600	76149	ATTENUATOR, VARIABLE	EA	1
94	4	PAFZZ	5905-00-849-4402	234	88183	TRANSFORMER, IMPEDANCE MATCHING	EA	1
						GROUP 100405 FREQUENCY SHIFT TONE KEYSYSTEM 211, MODEL 2		
95	1	PAFZZ	5905-00-683-2238	RC07GF103J	81349	RESISTOR, FIXED, FILM	EA	6
95	2	PAFZZ	5910-00-854-0568	SCMS17GP006D4	01295	CAPACITOR, FIXED, ELECTROLYTIC	EA	1
95	3	PAFZZ	5910-00-854-0519	SCM106BP010D4	01295	CAPACITOR, FIXED, ELECTROLYTIC	EA	3
95	4	PAFZZ	5950-00-755-4163	DOT20	89665	TRANSISTOR	EA	7
95	5	PAFZZ	5905-00-681-8853	RC07GF683J	81349	RESISTOR, FIXED, COMPOSITION	EA	3
95	6	PAFZZ	5905-00-681-8818	RC07GF153J	81349	RESISTOR, FIXED, COMPOSITION	EA	4
95	7	PAFZZ	5905-00-603-2242	RC07GF471J	81349	RESISTOR, FIXED, COMPOSITION	EA	1
95	8	PAFZZ	5905-00-577-1792	RN6083161F	81349	RESISTOR, FIXED, FILM	EA	2
95	9	PAFZZ	5960-00-731-1234	G130	01295	SEMICONDUCTOR DEVICE, DIODE	EA	5
95	10	PAFZZ	5905-00-114-0711	RC07GF472J	81349	RESISTOR, FIXED, COMPOSITION	EA	1
95	11	PAFZZ	5905-00-299-1541	RC20GF151	81349	RESISTOR, FIXED, COMPOSITION	EA	1
95	12	PAFZZ	5905-00-849-7077	RH510	01121	RESISTOR, VARIABLE	EA	1
95	13	PAOZZ	5920-00-655-3806	F03GR0108	96906	FUSE, CARTRIDGE	EA	1
95	14	PAFZZ	5920-00-251-7611	4405	71400	FUSEHOLDER	EA	1
95	15	PAFZZ	5905-00-279-1979	RC42GF10LK	81349	RESISTOR, FIXED, COMPOSITION	EA	1
95	16	PAFZZ	5910-00-848-8987	SCM107HP006D4	01295	CAPACITOR, FIXED, ELECTROLYTIC	EA	1
95	17	PAFZZ	5935-00-553-3181	57-10140	02660	CONNECTOR, RECEP, ELECTRICAL	EA	2
95	18	PAFZZ	5905-00-683-2240	RC07GF221J	81349	RESISTOR, FIXED, COMPOSITION	EA	2
95	19	PAFZZ	5905-00-110-7620	RC07GF1102J	81349	RESISTOR, FIXED, COMPOSITION	EA	1
95	20	PAFZZ	5910-00-848-8985	SC1007GP01004	01295	CAPACITOR, FIXED, ELECTROLYTIC	EA	1
95	21	PAFZZ		NRC234	88183	TRANSFORMER	EA	1
95	22	PAFZZ	5915-00-849-9072	NRC641	88183	FILTER, BANDPASS	EA	7
95	23	PAFZZ	5905-00-727-8001	RC07GF681J	81349	RESISTOR, FIXED, COMPOSITION	EA	1
95	24	PAFZZ	5905-00-723-5251	RC07GF222J	81349	RESISTOR, FIXED, COMPOSITION	EA	1
95	25	PAFZZ	5910-00-854-0566	SCM106BP020D4	96214	CAPACITOR, FIXED, ELECTROLYTIC	EA	1
95	26	PAFZZ	5905-00-114-0710	RC07GF331J	81349	RESISTOR, FIXED, COMPOSITION	EA	1
95	27	PAFZZ	5905-00-683-7721	RC07GF105J	81349	RESISTOR, FIXED, COMPOSITION	EA	1

REPAIR PARTS LIST

(1) ILLUSTRATION		(2)	(3)	(4)	(5)	(6) DESCRIPTION	(7)	(8)
(a) FIG NO.	(b) ITEM NO.	SMR CODE	NATIONAL STOCK NUMBER	PART NUMBER	FSCM	USABLE ON CODE	U/M	QTY INC IN UNIT
95	28	PAFZZ	5905-00-723-5251	RC07GF222J	81349	RESISTOR, FIXED, COMPOSITION	EA	8
95	29	PAFZZ	5910-00-892-7312	CPO5A1KB154K	81349	CAPACITOR, FIXED, PAPER	EA	3
95	30	PAFFF	5805-00-884-5283	211Z15	88183	FREQUENCY SHIFT, TONE KEYER	EA	1
95	31	PAFFF	5805-00-884-5282	211Z14	88183	FREQUENCY SHIFT, TONE KEYER	EA	1
95	32	PAFFF	5805-00-884-5281	211Z13	88183	FREQUENCY SHIFT, TONE KEYER	EA	1
95	33	PAFFF	5805-00-884-5280	211Z12	88183	FREQUENCY SHIFT, TONE KEYER	EA	1
95	34	PAFFF	5805-00-884-5293	211Z7	88183	FREQUENCY SHIFT, TONE KEYER	EA	1
95	35	PAFZZ	5805-00-884-5294	211Z6	88183	FREQUENCY SHIFT, TONE KEYER	EA	1
95	36	PAFFF	5805-00-884-5295	211Z5	88183	FREQUENCY SHIFT, TONE KEYER	EA	1
95	37	PAFFF	5805-00-884-5296	211Z4	88183	FREQUENCY SHIFT, TONE KEYER	EA	1
95	38	PAFZZ	5910-00-688-2822	CP05A1KB104K	81349	CAPACITOR, FIXED, PAPER	EA	6
95	39	PAFZZ	5905-00-849-4422	GA2N040S253UZ	81349	RESISTOR, VARIABLE	EA	1
95	40	PAFZZ	5910-00-823-1538	CP05A1KC223K3	81349	CAPACITOR, FIXED, PAPER	EA	4
95	41	PAFZZ	5905-00-866-5184	GA2N040S502MZ	08313	RESISTOR, VARIABLE	EA	8
95	42	PAFZZ		GA2N040S502MZ-2	81349	RESISTOR, VARIABLE	EA	1
95	43	PAFZZ	5935-00-539-2045	MS16108-2	96906	JACK, TIP	EA	1
95	44	PAFZZ	5935-00-542-9821	MS16108-7	96906	JACK, TIP	EA	1
95	45	PAFZZ	5935-00-552-7613	MS16108-1	96906	JACK, TIP	EA	1
						GROUP 1005 COMBINED FUNCTION PANEL		
96	1	XDFFF	5940-00-912-1809	TF154-4012VDC	02288	PANEL, COMBINED FUNCTION	EA	1
96	1	PAFZZ	5930-00-820-9131	T2150	81640	SWITCH TOGGLE	EA	16
96	2	PAFZZ	6210-00-186-7916	95-457	72619	LIGHT, INDICATOR	EA	19
96	3	PAFZZ	6240-00-155-8707	MS15571-6	96906	LAMP, INCANDESCENT	EA	19
96	4	PAFZZ	6210-00-030-2444	95-937	72619	LENS, INDICATOR, LIGHT	EA	18
96	5	PAFZZ		95-937-72619	72619	LENS, INDICATOR, LIGHT	EA	1
96	6	PAFZZ	5940-00-549-9352	12-164	71785	BARRIER TERMINAL	EA	2
96	7	PAFZZ	5905-00-665-6850	RW31V202	81349	RESISTOR FIXED WIRE WOUND	EA	5
96	8	PAFZZ	5945-00-912-1809	155CCCC	02288	RELAY, ARMATURE	EA	4
96	9	PAFZZ	5905-00-279-3503	RC32GF682J	81349	RESISTOR, FIXED COMPOSITION	EA	4
96	10	PAFZZ	5940-00-552-4518	16-164	71785	BARRIER TERMINAL	EA	3
						GROUP 1006 AUDIO PATCH PANEL		
97	1	PAFZZ	5905-00-279-3506	RC20GF332J	81349	RESISTOR, FIXED, COMPOSITION	EA	36
97	2	PAFZZ	5935-00-201-8057	410C	90044	JACK, TELEPHONE	EA	48
97	3	PAFZZ	5935-00-192-4809	303A	90044	JACK, TELEPHONE	EA	48
97	4	PAFZZ	5935-00-815-4721	MT332C	82389	JACK, TELEPHONE	EA	48
						GROUP 1007 TONE CONVERTER SHELF NO. 1 TYPE 222, MODEL 5		

SECTION II. REPAIR PARTS LIST

TM 11-5895-288-24P

(1) ILLUSTRATION		(2)	(3)	(4)	(5)	(6)	(7)	(8)
(a) FIG NO.	(b) ITEM NO.	SMR CODE	NATIONAL STOCK NUMBER	PART NUMBER	FSCM	DESCRIPTION USABLE ON CODE	U/M	QTY INC IN UNIT
98	1	PAFZZ	5935-00-646-5890	26-4201-8S	02660	CONNECTOR,RECEP,ELECTRICAL	EA	1
98	2	PAFZZ	593-00-283-3826	MS16108-3	96906	JACK,TIP	EA	1
98	3	PAFZZ	5935-00-552-7978	57-20140	02660	CONNECTOR.RECEP.ELECTRICAL	EA	8
98	4	PAFZZ	5935-00257-8546	P2028	07233	CONNECTOR,RECEP,ELECTRICAL	EA	1
98	5	PAFZZ	5935-00-553-3181	57-10140	02660	CONNECTOR,I,RECEP,ELECTRICAL	EA	1
98	6	PAFZZ	5933-00-636-7145	UP21SM	81349	CONNECTOR.PLUG,ELECTRICAL	EA	1
98	7	PAFZZ	5805-00-871-0155	693	88183	ISOLATION SUB-ASSY	EA	1
98	8	PAFZZ	5950-00854-0494	NRC234	8183	TRANSFORMER,AUOIOFREQUENCY	EA	1
98	9	PAFZZ	5905-00-851-4199	T600	76149	ATTENUATOR.VARIABLE	EA	1
98	10	PAFZZ	5945-00-852-0465	KRPSO	77342	RELAY,ARMATURE	EA	1
98	11	PAFZZ	5935-00-129-9358	TS101PO2	81349	SOCKET,ELECTRON TUBE	EA	1
98	12	PAFZZ	5905-00-279-2522	RC20CF154J	81349	RESISTOR,FIXED,COMPOSITION	EA	1
98	13	PAFZZ		NRCTYPE222MODEL5	88183	SHELVES.TONE CONVERTER	EA	1
98	14	PAFZZ	5920-00-553-7116	HKLX	71400	FUSEHOLDER	EA	2
98	15	PAOZZ	5920-00-199-9498	FO2GRS008	81349	FUSE,CARTRIDGEGE	EA	2
98	16	PAOZZ	6240-00-223-9100	NE51	60969	LAMP,GLOW	EA	1
98	17	PAFZZ	6210-00-851-6307	26408-1137	72619	LIGHT,INDICATOR	EA	1
98	18	PAFZZ	5930-00-615-7877	MS35059-24	96906	SWITCH.TOGGLE	EA	1
98	19	PAFZZ	5930-00-655-1582	NS35059-23	96906	SWITCH.TOGGLE	EA	1
98	20	PAFZZ	5935-00-857-6547	S202CCT	07233	CONNECTOR,PLUG,ELECTRICAL	EA	1
98	21	PAFZZ	5940-00-636-5485	18-140-34I	07233	TERMINAL 80ARD	EA	4
						GROUP 100704 DIVERSITY CONIMNER,TYPE 234,MODEL 2		
99	1	PDFFF		MRCTYPE234MODEL2	88183	COMBINER,DIVERSITY	EA	1
99	2	PAFZZ	5905-00-683-TT772	RC07CGFIOJ	81349	RESISTOR.FIXED.CONPOSITION	EA	4
99	3	PAFZZ	5905-00-849-7077	SHSO1K	08313	RESISTOR.,ARIABLE	EA	2
99	4	PAFZZ	5950-00-68-8760	RN6084640F	81349	RESISTOR,FIXED,FILM	EA	4
99	5	PAFZZ	590-00-683-2238	RCO07FIO3J	81349	RESISTOR,FIXEO,CONPOSITION	EA	3
99	6	PAFZZ	5960-00-354-0552	2N652A	94990	TRANSISTOR	EA	12
99	7	PAFZZ	5910-00-712-8697	DDA503	71590	CAPACITOR.FIXED,CERAMIC	EA	2
99	8	PAFZZ	5961-00-852-7549	IN754A	81349	SEMICONDUCTOR DEVICE,DIODE	EA	1
99	9	PAFZZ	5960-00-731-1234	G130	01295	SEMICONDUCTOR DEVICE,DIODE	EA	2
99	10	PAFZZ	5905-00-683-2235	RC07GF6DOJ	81349	RESISTOR,FIXED,COMPOSITION	EA	1
99	11	PAFZZ	5910-00-849-3783	UK225	71590	CAPACITOR,FIXED.CERAMIC	EA	2

SECTION II. REPAIR PARTS LIST

TM 11-5895-288-24P

(1) ILLUSTRATION		(2)	(3)	(4)	(5)	(6)	(7)	(8)
(a) FIG NO.	(b) ITEM NO.	SMR CODE	NATIONAL STOCK NUMBER	PART NUMBER	FSCM	DESCRIPTION USABLE ON CODE	U/M	QTY INC IN UNIT
99	12	PAFZZ	5905-00-060-5100	GA2NO40SSOIMZ	08313	RESISTOR,VARIA8LE	EA	2
99	13	PAFZZ	5905-00-681-6894	RN6083160F	81349	RESISTOR.FIXED,FILM	EA	1
99	14	PAFZZ	5905-00-683-2240	RC07GF221J	81349	RESISTOR,FIXED,COPOSITION	EA	1
99	15	PAFZZ	5905-00-952-2146	RN605L111F	81349	RESISTOR,FIXED,FILM	EA	7
99	16	PAFZZ	5905-00-687-0007	RN6OCS51R1F	81349	RESISTOR,FIXED,FILM	EA	2
99	17	PAFZZ	5910-00-825-0403	00A104	71590	CAPACITOR,FIXEO,CERAMIC	EA	2
99	18	PAFZZ	5905-00-702-1143	RN60814T2F	81349	RESISTOR,FIXEO,FILM	EA	2
99	19	PAFZZ	6625-00-892-5623	MRO05OO1DCMA	81349	ANRETER,PANEL TYPE	EA	2
99	20	PAFZZ	5935-00-552-7613	NS16108-1	9gM08	JACK,TIP	EA	3
99	21	PAFZZ	5905-00-114-0711	RCOTGF472J	81349	RESISTOR,FIXED,CDOPOSITION	EA	1
99	22	PAFZZ	5935-00-283-3826	MS16108-3	9e0t	JACK,TIP	EA	1
99	23	PAFZZ	5935-00-539-2045	MS16108-2	9MB0B	JACK.TIP	EA	1
99	24	PAFZZ	5305-00-861-7247	7-0332	88183	THUMBSCREW	EA	1
99	25	PAFZZ	5905-00-106-1356	RCO7GFIS2J	81349	RESISTOR,FIXED,COMPOSITION	EA	3
99	26	PAFZZ	5905-00-110-7820	RC07GF102J	81349	RESISTOR,FIXEOD,COPOSITION	EA	1
99	27	PAFZZ	5961-00-615-0095	IN276	81349	SEMICONDUCTOR DEVICE,DIODE	EA	4
99	28	PAFZZ	5950-00-851-4221	00T25	89665	TRANSFORMER,AUDIOFREQUENCY	EA	2
99	29	PAFZZ	5935-00-553-3181	57-10140	02660	CONNECTOR,RECEP,ELECTRICAL	EA	1
99	30	PAFZZ	5960-00-854-0552	2N652A	94990	TRANSISTOR,GERMANIUM	EA	2
						GROUP 100705 DOTTER AND DELAY INDICATOR		
100	1	PAFZZ	5905-00-849-4422	GA2NO40S253UZ	08313	RESISTOR,VARIANLE	EA	1
100	2	PAFZZ	5905-00-683-2240	RC07GF221J	81349	RESISTOR,FIXED,COMPOSITION	EA	2
100	3	PAFZZ	5960-00-854-0552	2N652A	94990	TRANSISTOR	EA	11
100	4	PAFZZ	5905-00-676-8776	RN6087500F	81349	RESISTOR,FIXEDOFILM	EA	2
100	5	PAFZZ	5905-00-683-2242	RCO7GF471J	81349	RESISTOR.FIXEDO,ILM	EA	2
100	6	PAFZZ	5905-00-808-1478	RN6083830F	81349	RESISTOR,FIXED,FILM	EA	2
100	7	PAFZZ	5910-00-848-8988	SCM337HP00604	01295	CAPACITOR,FIXEO.ELECTROLYTIC	EA	2
100	8	PAFZZ	5961-00-577-6084	1N645	81349	SEMICONDUCTOR DEVICE.DIOOE	EA	4
100	9	PAFZZ	5910-00-820-6114	CPOSA1KC474MT	81349	CAPACITOR,FIXED,PAPER	EA	2
100	10	PAFZZ	5905-00-855-3173	RC07GF682J	81349	RESISTOR,FIXEO,CODPOSITION	EA	2
100	11	PAFZZ	5905-00-681-8818	RCO7GF153J	81349	RESISTOR,FIXED.COMPOSITION	EA	4
100	12	PAFZZ	5905-00-681-9969	RCOTGF332J	81349	RESISTOR,FIXED,COMPOSITIDN	EA	6
100	13	PAFZZ	5905-00-683-2243	RCOT7GFI151J	81349	RESISTOR.FIXED.COMPOSITION	EA	3
100	14	PAFZZ	5910-00-810-4849	TGSIO	56289	CAPACITOR,FIXEODCERAMIC	EA	3
100	15	PAFZZ	5910-00-848-8987	SCM10THP02004	01295	CAPACITOR,FIXED,ELECTROLYTIC	EA	1
100	16	PAFZZ	5960-00-581-8619	IN538	81349	SEMICONDUCTOR DEVICE,DIODE	EA	1
100	17	PAFZZ	5905-00-279-1692	RC32GFIOOK	81349	RESISTOR,FIXED,COMPOSITION	EA	1
100	18	PAFZZ	5960-00-731-1234	G130	01295	SEMICONDUCTOR DEVICE.DIOOE	EA	1
100	19	PAFZZ	5905-00-683-2238	RC07GF103J	81349	RESISTOR,FIXED,COMPOSITION	EA	3
100	20	PAFZZ	5960-00-752-6136	2N1011	81349	TRANSISTOR	EA	1

SECTION II. REPAIR PARTS LIST

TM 11-5895-288-24P

(1) ILLUSTRATION		(2)	(3)	(4)	(5)	(6)	(7)	(8)
(a) FIG NO.	(b) ITEM NO.	SMR CODE	NATIONAL STOCK NUMBER	PART NUMBER	FSCM	DESCRIPTION USABLE ON CODE	U/M	QTY INC IN UNIT
100	21	PAFZZ	5935-00-553-3181	57-10140	02660	CONNECTOR,RECEP,ELECTRICAL	EA	1
100	22	XDFFD		275MODEL 1	74130	INDICATOR.DOTTER AND DELAY	EA	1
100	23	PAFZZ	5905-00-110-7620	RC07GF102J81349		RESISTORFIXED,COMPOSITION	EA	1
100	24	PAFZZ	5905-00-686-3903	RC07GF333J81349		RESISTOR,FIXED,COMPOSIT1ON	EA	3
100	25	PAFZZ	5905-00-114-0711	RC07GF472J81349		RESISTOR,FIXED,COMPOSITION	EA	2
100	26	PAFZZ	5905-00-686-9995	RC07GF154J	81349	RESISTOR,FIXED.COMPOSITION	EA	2
100	27	PAFZZ	5935-00-779-8426	14T24324	07233	SOCKET ASSY,TRANSISTOR	EA	1
100	28	PAFZZ	5905-00-106-1356	RC07GF152J	81349	RESISTORIFIXED,COMPOSITION	EA	1
100	29	PAFZZ	5355-00-889-3468	E1408	01591	KNOB,SET SCREW TYPE	EA	1
100	30	PAFZZ	5935-00-552-7613	MS16108-1	96906	JACK,TIP	EA	2
100	31	PAFZZ	5935-00-539-5944	SCA28	76149	JACK.TELEPHONE	EA	1
100	32	PAFZZ	5960-00-852-7549	1N754A	81349	SEMICONDUCTOR DEVICEIOIDE	EA	1
100	33	PAFZZ	5960-00-754-5897	1N705A	73293	SEMICONDUCTOR DEVICE,DIODE	EA	1
100	34	PAFZZ	6625-00-857-5299	MR25WSTSDCUA	81349	MILLIAMMETER,PANEL TYPE	EA	1
100	35	PAFZZ	5930-00-854-3135	PA1001	07886	SWITCH,ROTARY	EA	1
100	36	PAFZZ	5305-00-861-7247	7-0332	88183	THUMBSCREW	EA	2
100	37	PAFZZ	91000--4--7163	TG-P10	56289	CAPACITOR FIXED CERAMIC	EA	2
						GROUP 100706 FREQUENCY SHIFT TONE CONVERTER TYPE 212,MODEL 3		
101	1	PAFZZ	5935-00-552-7613	MS16108-1	96906	JACK TIP	EA	3
101	2	PAFZZ	5960-00-731-1234	G130	01295	SENICONDUCTOR OEVICE,DIODE	EA	3
101	3	PAFZZ	5950-00-851-4221	DOT25	89665	TRANSFORCKER,AUDIO FREQUENCY	EA	2
101	4	PAFZZ	5905-114-0710	RC07GF331J	81349	RESISTOR,FIXED,COPOSITION	EA	2
101	5	PAFZZ	5905-00-683-2240	RC07GF221J	81349	RESISTOR,FIXED.COMPOSITION	EA	4
101	6	PAFZZ	5960-00-854-0552	2N652A	81349	TRANSISTOR	EA	1
101	7	PAFZZ	5905-00-110-7620	RC07GF102J	81349	RESISTOR.FIXEO.CONPOSITION	EA	4
101	8	PAFZZ	5905-00-279-3519	RC20GF220K	81349	RESISTOR,FIXED,COMPOSITION	EA	2
101	9	PAFZZ	5910-00-814-7653	SCH157HP01504	01295	CAPACITOR.FIXED.ELECTROLYTIC	EA	1
101	10	PAFZZ	5905-00-060-2790	RH101M	08313	RESISTOR,VARIABLE	EA	1
101	11	PAFZZ	5905-00-723-5251	RC07GF222J	81349	RESISTOR,FIXED,COMPOSITION	EA	2
101	12	PAFZZ	5935-00-553-3181	57-10140	02660	CONNECTOR,RECEP,ELECTRICAL	EA	1
101	13	PAFZZ	5905-00-681-9969	RCO7GF332J	81349	RESISTOR,FIXED,COMPOSITION	EA	5
101	14	PAFZZ	5905-00-686-3903	RC07GF333J	81349	RESISTOR.FIXED.COMPOSITION	EA	2
101	15	PAFZZ	5905-00-114-0711	RC07GF472J	81349	RESISTOR,FIXED,COMPOSITION	EA	3
101	16	PAFZZ	5905-00-683-2238	RC07GF103J	81349	RESISTOR.FIXED,COMPOSITION	EA	3
101	17	PAFZZ	5905-00-299-2058	RC32GF151K	81349	RESISTOR,FIXED.COMPOSITION	EA	1
101	18	PAFZZ	5905-00-681-8818	RC07GF153J	81349	RESISTOR,FIXED,COMPOSITIDN	EA	1
101	19	PAFZZ	5905-00-687-0002	RC07GF223J	81349	RESISTOR,FIXED,COMPOSITION	EA	2
101	20	PAFZZ	5910-00-712-8697	00A503	71590	CAPACITOR,FIXED.CERAMIC	EA	2
101	21	PAFZZ	5105-00-861-7247	7-0332	88183	THUMBSCREW	EA	2
101	22	PAFZZ	5935-00-552-7613	M516108-1	90906	JACK TIP	EA	1
101	23	PAFFF	5805-00-886-5947	212	88183	FREQUENCY SHIFT TONE CONVERTER	EA	16

SECTION II. REPAIR PARTS LIST

TM 11-5895-288-24P

(1) ILLUSTRATION		(2)	(3)	(4)	(5)	(6)	(7)	(8)
(a) FIG NO.	(b) ITEM NO.	SMR CODE	NATIONAL STOCK NUMBER	PART NUMBER	FSCM	DESCRIPTION USABLE ON CODE	U/M	QTY INC IN UNIT
						GROUP 10070601 RELAY ASSEMBLY TYPE 692A		
102	1	POFFF	5945-00-887-0760	NRC692	06778	RELAY OUTPUT PLUG IN ASSY	EA	1
102	2	PAFZZ	5935-00-173-7748	SD349082-1	81351	CONNECTOR, PLUG, ELECTRICAL	EA	1
102	3	PAFZZ	5945-00-615-1457	72AOZ160TSTCP	78277	RELAY, ARMATURE. SPDT	EA	1
102	4	PAFZZ	5935-00-129-9358	TS101P02	81349	SOCKET, ELECTRON TUBE	EA	1
102	5	PAFZZ	5905-00-195-6806	RC206GF102J	81349	RESISTOR, FIXED, COMPOSITION	EA	1
102	6	PAFZZ	5905-00-279-1176	RC20GF222J	81349	RESISTOR, FIXED, COMPOSITION	EA	2
102	7	PAFZZ	5961-00-752-6121	1N753A	1349	SEMICONDUCTOR DEVICE, DIODE	EA	1
102	8	PAFZZ	5910-00-810-4848	40C258	56289	CAPACITOR, FIXED, CERAMIC	EA	1
102	9	PAFZZ	5905-00-192-3973	RC20GF471J	81349	RESISTOR, FIXED, COMPOSITION	EA	1
102	10	PAFZZ	5960-00-854-0552	2N652A	94990	TRANSISTOR	EA	2
102	11	PAFZZ		RC206F472N	1349	RESISTOR FIXED COMPOSITION	EA	1
102	12	PAFZZ	5910-00-810-4849	TGS10	56289	CAPACITOR, FIXED, CERAMIC	EA	3
102	13	PAFZZ	5910-00-577-3282	TGP10.33C41	56289	CAPACITOR, FIXED, CERAMIC	EA	1
						GROUP 10010602 FREQUENCY DETERMINING AND DELAY NETWORK TYPE NRC 212-3Z04.012		
103	1	PAFZZ	5910-00-543-0606	30-315	72143	CAPACITOR, VARIABLE, MICA	EA	3
103	2	PAHZZ	5905-00-849-4434	RN60G2492F	81349	RESISTOR, FIXED, FILM	EA	4
103	3	PAFZZ	5960-00-577-6084	1N645	82679	SEMICONDUCTOR DEVICE, DIODE	EA	4
103	4	PAFZZ	5910-00-825-0403	DOA104	71590	CAPACITOR, FIXED, CERAMIC	EA	2
103	5	PAFZZ	5905-00-985-5435	RN6087501F	81349	RESISTOR, FIXED, FILM	EA	2
103	6	PAFZZ		UK1050S	71590	CAPACITOR, FIXED, CERAMIC	EA	1
103	7	PAFZZ	5905-00-681-9969	RC07GF332J	1349	RESISTOR, FIXED, COMPOSITION	EA	1
103	8	PAFZZ	5905-00-110-7620	RC07F102J	81349	RESISTOR, FIXED, COMPOSITION	EA	1
103	9	PAFZZ	5905-00-849-7077	RH501M	01121	RESISTOR, VARIABLE	EA	1
103	10	PAFZZ	5960-00-731-1234	G130	82679	SEMICONDUCTOR DEVICE, DIODE	EA	1
103	11	PAFZZ	5905-00-801-6998	RC07CF621J	81349	RESISTOR, FIXED, COMPOSITION	EA	2
103	12	PAFZZ	5960-00-854-0552	2N652A	81349	TRANSISTOR	EA	1
103	13	PAFZZ	5905-00-683-2238	RC07GF103J	81349	RESISTOR, FIXED, COMPOSITION	EA	1
103	14	PAFZZ	5905-00-849-4321	RH103H	01121	RESISTOR, VARIABLE	EA	1
103	15	PAFZZ	5905-00-49-4322	RHS03N	01121	RESISTOR, VARIABLE	EA	1
103	16	PAFZZ	5950-00-060-4120	SP67	81349	TRANSFORMER, AUDIO FREQUENCY	EA	1
103	17	PAFZZ	5935-00-173-7748	DA1SP	71468	CONNECTOR, PLUG, ELECTRICAL	EA	1
103	18	PAFZZ	5915-00-862-2757	NRC886	88183	TANK CIRCUIT	EA	8
103	19	PAFZZ	5915-00-862-2755	NRC904	88183	TANK CIRCUIT	EA	8
103	20	PAFZZ	5915-00-49-7500	NRC697	88183	FILTER, 8AND PASS	EA	8
103	21	PAFFF	6210-00-862-2764	NRC212-3ZD4	88183	FREQUENCY DETERMINING, DELAY	EA	15
						GROUP 1008 TONE CONVERTER SHELVES NO 2 AND 3, TYPE 222, MODEL 4		
104	1	PAFZZ	5935-00-857-6547	S202CCT	01233	CONNECTOR, PLUG, ELECTRICAL	EA	2
104	1A	PAFZZ	5935-00-646-5890	26-4201-8S	02660	CONNECTOR, RECEPT, ELECTRICAL	EA	2

SECTION II. REPAIR PARTS LIST

TM 11-5895-288-24P

(1) ILLUSTRATION		(2)	(3)	(4)	(5)	(6)	(7)	(8)
(a) FIG NO.	(b) ITEM NO.	SMR CODE	NATIONAL STOCK NUMBER	PART NUMBER	FSCM	DESCRIPTION USABLE ON CODE	U/M	QTY INC IN UNIT
104	2	PAFZZ	5935-00-283-3826	M516108-3	10006	JACK.TIP	EA	1
104	3	PAFZZ	5935-00-552-7976	57-20140	02660	CONNECTOR,RECEP,ELECTRICAL	EA	7
104	4	PAFZZ	5935-00-553-3181	57-10140	02660	CONNECTOR,RECEP,ELECTRICAL	EA	1
104	5	PAFZZ	5935-00-636-7145	UP121M	81349	CONNECTOR.PLUG,ELECTRICAL	EA	1
104	6	PAFZZ	5805-00-871-0155	693	88183	ISOLATION SUB-ASSY	EA	1
104	7	PAFZZ		NRC234	88183	TRANSFORMER.AUDIOFREQUENCY	EA	1
104	8	PAFZZ	5905-00-279-2522	RC2OGF514J	81349	RESISTOR,FIXED,COMPOSITION	EA	1
104	9	PAFZZ	59450-852-0465	KRPSD	77342	RELAY,ARMATURE	EA	1
104	10	PAFZZ	5935-00-129-9358	TS101P02	81349	SOCKET,ELECTRON TUBE	EA	1
104	11	PAFZZ	5905-00-851-4199	T600	76149	ATTENUATOR,VARIABLE	EA	1
104	12	PAFFF	5805-00-870-2289	NRCTYPE222MODEL4	88183	SHELVES,TONE CONVERTER	EA	1
104	13	PAFZZ	5920-00-553-7116	XKLX	71400	FUSEHOLDER	EA	2
104	14	PAOZZ	5920-00-199-9498	FO2GRS00B	81349	FUSE,CARTRIDGE	EA	2
104	15	PAOZZ	6240-00-223-9100	NESI	60969	LAMP,GLOW	EA	1
104	16	PAFZZ	6210-00-851-6307	26408-1137	72619	LIGHT,INDICATOR	EA	1
104	17	PAFZZ	5935-00-2-28598	5S35059-24	81349	SWITCH,TOGGLE	EA	1
104	18	PAFZZ	5930-00-655-1582	1S35059-23	11349	SWITCH,TOGGLE	EA	1
104	19	PAFZZ	5935-0-257-8546	P2028	07233	CONNECTOR,RECEP,ELECTRICAL	EA	1
104	20	PAFZZ	5940-00-983-6059	18-140-34W	07233	TERMINAL BOARD	EA	4
						GROUP 1013 ORDER WIRE HYBRID		
105	1	PAFZZ		CRLACS9-102U	71590	RESISTOR,VARIABLE	EA	2
105	2	PAFZZ	5905-00-279-2650	RC32GF562J	81349	RESISTOR,FIXED,COMPOSITION	EA	2
105	3	PAFZZ	5910-00-944-2051	CE13C240Q	81349	CAPACITOR,FIXED ELECTROLYTIC	EA	1
						GROUP 1102 COOLING FAN		
106	1	PAFZZ		S1364	03522	BLOWER WHEEL COUNTERWISE	EA	1
106	2	PAFZZ		S1365	03522	BLOWER WHEEL COUNTERCLOCKWISE	EA	1
106	3	PAFZZ		S2006	03522	MOTOR,AC	EA	1
106	4	PAFZZ	5910-00-972-9420	S1309	03522	CAPACITOR,DIELECTRIC	EA	1
106	5	PAFZZ		51083	03522	PAINT,SPRAY	EA	1

SECTION II. REPAIR PARTS LIST

TM 11-5895-288-24P

(1) ILLUSTRATION		(2)	(3)	(4)	(5)	(6)	(7)	(8)
(a) FIG NO.	(b) ITEM NO.	SMR CODE	NATIONAL STOCK NUMBER	PART NUMBER	FSCM	DESCRIPTION USABLE ON CODE	U/M	QTY INC IN UNIT
106	6	PAFZZ	4130-00-925-0509	51006-20	03522	FILTER,WASNABLE	EA	1
106	7	XDFFF		2EB4128	03522	FAN ASSEMBLY	EA	1
						GROUP 1103 INSTALLATION KIT FOR TSEC/KW-26		
107	1	PFFFF	5810-00-252-4494	TSECKW26	82679	INSTALLATION KIT	EA	4
107	2	PAFZZ	5915-00-195-8761	106234	98230	FILTER,BAND PASS	EA	4
107	3	PAFZZ	5915-00-955-0610	FA9841	51432	FILTER,RADIO FREQUENCY	EA	4
107	4	PAFZZ	5905-00-279-3513	RC42GF221J	81349	RESISTOR,FIXED COMPOSITION	EA	4
107	5	PAFZZ	5905-00-892-5202	RC42GF471TJ	81349	RESISTOR,FIXED COMPOSITION	EA	4
107	6	PAFZZ	5905-00-279-3506	RC20GF334J	81349	RESISTOR,FIXED COMPOSITION	EA	4
						GROUP 12 TEST EQUIPMENT		
107.1	1	PAOFF		FR114U	82679	FREQUENCY METER	EA	1
107.1	2	PAOFF		E26U	82679	MULTIMETER	EA	1
137.1	3	PAOFF		TS352BU	82679	MULTIMETER	EA	1
137.1	4	PAOFF		OS8U	82679	OSCILLOSCOPE	EA	1
137.1	5	PAOFF		TS2/TG	02679	TEST SET,TELETYPENRITER	EA	1
137.1	6	PAOFF		TS1066/GG	82679	TEST SET,TELETYPEWRITER	EA	1
137.1	T	PAOFF		TS1100/U	82679	TEST SET,TRANSISTOR	EA	1
107.1	8	PAOFF		TS1194/U	82679	TEST SET,RELAY	EA	1
107.1	9	PAOFF		TS1836/U	82679	TEST SET,TRANSISTOR	EA	1
107.1	10	PAOFF		TV7/U	82679	TEST SET,ELECTRON TUBE	EA	1

SECTION II. REPAIR PARTS LIST

TM 11-5895-288-24P

(1) ILLUSTRATION		(2)	(3)	(4)	(5)	(6)	(7)	(8)
(a) FIG NO.	(b) ITEM NO.	SMR CODE	NATIONAL STOCK NUMBER	PART NUMBER	FSCM	DESCRIPTION USABLE ON CODE	U/M	QTY INC IN UNIT
						GROUP 13 MISCELLANEOUS GROUP 1301 PANEL,POWER CONTROL		
108	1	PAFZZ		QO-115	14280	CIRCUIT BREAKER	EA	7
108	2	PAFZZ	5925-00-583-7941	QP120	14280	CIRCUIT BREAKER	EA	3
108	3	PAFZZ	5925-00-733-8240	QO-320	14280	CIRCUIT BREAKER	EA	1
108	4	PAFZZ	5925-00-682-4096	QO-130	14280	CIRCUIT BREAKER	EA	1
108	5	PAOZZ	6240-00-179-1814	NE45	24455	LAMP,GLOW	EA	2
108	6	PAFZZ	6210-00-752-1233	4-74-6	95263	LAMPHOLDER	EA	2
108	7	PAFZZ	5925-00-733-8238	QO-350	14280	CIRCUIT BREAKER	EA	2
108	8	PAFZZ	5925-00-886-3292	Q1370	14280	CIRCUIT BREAKER	EA	1
108	9	PAFZZ	5925-00-063-5798	3X1076SK	74193	CIRCUIT BREAKER	EA	1
						GROUP 1302 IDF/MDF BOX		
109	1	PAFZZ	5950-00-646-4287	360-70	71688	HEAT COIL,TELEPHONE	EA	50
						GROUP 1303 TRANSFER SWITCH		
109.1	1	PDFFF		TSECKW7	82679	COMMUNICATION SECURITY EQUIPMENT	EA	4
109.1	2	PAFFF		634D	82389	TRANSFER SWITCH	EA	6
						GROUP 1305 DUMMY LOAD DA-314/U		
110		PDFFD	DA314U		82679	DUMMY LOAD DA-314U	EA	1
110	1	PAFZZ	5905-00-773-8191	RR117-140	82679	RESISTOR.FIXED,GLASS	EA	2
						GROUP 15 CABLE ASSEMBLIES		
						GROUP 1501 POWER CABLE		
111	1	PAFZZ	5935-00-826-4998	ZZMM24121550	49367	ADAPTER,CABLE TO CONNECTOR	EA	1
111	2	PAFZZ	6145-00-838-1384	OK4-171	49367	CABLE POWER ELECTRICAL	EA	104
111	3	PAFZZ	5935-00-885-6007	LZMWBIO16-10S	49367	CONNECTOR.PLUGC,ELECTRICAL	EA	1
111	4	PAFZZ	5935-00-885-6006	ZZMW2416-1850	49367	ADAPTER,CABLE TO CONNECTOR	EA	1
111	5	PBFFD	5995-00889-0602	1047-427C2	82679	CABLE ASSEMBLY	EA	1
						GROUP 1502 CABLE,PLUG,ELECTRICAL		
112	1	PAFZZ		SC04195-1	80063	CABLE POWER ELECTRICAL	EA	8
112	2	PAFZZ	5935-00-29-5361	7259	74545	CONNECTOR,ELECTRICAL RECEP	EA	1
112	3	PAFZZ	5995-00-164-6584	S10-4195	0063	CABLE ASSEMBLY POWER.ELEC	EA	1
112	4	PAFZZ	5995-00-68-4284	CD370	82679	CABLE ASSEMBLY,POWER,ELEC	EA	3
112	5	PAFZZ	5935-00-149-4013	7057	74545	CONNECTOR,PLUC,ELECTRICAL	EA	1
					91			

SECTION II. REPAIR PARTS LIST

TM 11-5895-288-24P

(1) ILLUSTRATION		(2)	(3)	(4)	(5)	(6)	(7)	(8)
(a) FIG NO.	(b) ITEM NO.	SMR CODE	NATIONAL STOCK NUMBER	PART NUMBER	FSCM	DESCRIPTION USABLE ON CODE	U/M	QTY INC IN UNIT
113	1	PAFZZ	5940-00-552-4518	16-164		GROUP 1503 ELECTRICAL POWER CABLE		
113	2	PAFZZ	5995-00-956-4398	17106	71785	BARRIER TERMINAL	EA	1
113	3	PAFZZ	5935-00-258-1270	7092	70903	CABLE,POWER ELECTRICAL	EA	6
					74545	CONNECTOR,PLUG,ELECTRICAL	EA	1
						GROUP 1504 CORD ASSEMBLY		
114	1	PAFZZ	5995-00-170-6879	CD135A	80063	CORD ASSEMBLY,ELECTRICAL	EA	1
						GROUP 1505 CORD ASSEMBLY,ELECTRICAL		
114	2	PAFZZ	5,95-00-170-4868	P2A	64959	CORD ASSEMBLY,ELECTRICAL	EA	12
114	3	PAFFF	5995-00-161-8737	0164914	80063	CORD ASSEMBLY	EA	14
114	4	PAFZZ	6625-00-184-2910	S5C169374	80063	CORD ASSEMBLY,ELECTRICAL	EA	1
114	5	PAFZZ	5935-00-192-4883	2418	64955	PLUG,TELEPHONE	EA	2
						GROUP 1506 CABLE ASSEMBLY RADIO FREQUENCY CG-409E/U		
115	1	PAFFF	5995-00-926-3373	CG409EU	82679	CABLE ASSEMBLY RADIO FREQUENCY	EA	1
115	2	PAFFF	5995-00-636-0120	CG409EU	82679	CABLE ASSEMBLY, RADIO FREQUENCY	EA	1
115	3	PAFFF	5995-00-889-0590	CG409EU	82679	CABLE ASSEMBLY RADIO FREQUENCY	EA	2
115	4	PAFFF	5995-00-681-8482	CG409G	82679	CABLE ASSEMBLY, RADIO FREQUENCY	EA	1
115	5	PAFZZ	5995-00-456-2002	CG409G	82679	CABLE ASSEMBLY RADIO FREQUENCY	EA	1
115	6	PAFFF	5995-00-070-8747	CG409G	82679	CABLE ASSEMBY RADIO FREQUENCY	EA	
115	7	PAFFF	5995-00-490-1028	CG409G	82679	CABLE ASIEMBLY RADIO FREQUENCY	EA	1
115	8	PAFZZ	5935-00-681-5685	UG88CU	96906	CONNECTOR,PLUG,ELECTRICAL	EA	2
115	9	PAFZZ	6145-00-542-6092	RG58CU	96906	CABLE,ELECTRICAL	EA	1
115	10	PAFZZ		SMB180493	80063	STRIP ASSEMBLY,FANNING	EA	1
115	11	PAFZZ	5995000-538-9030	S1M8180489	80063	CABLE ELECTRICAL	EA	6
115	12	XBFZZ		NT137-1032	82879	CABLE.ELECTRICAL	EA	1
115	13	PAFZZ		SMB180491	80063	STRIP ASSEMBLY,FANNING	EA	1
115	14	PAFZZ		CA581-2	82679	CABLE POWER ASSY COILED	EA	1
115	15	PAFZZ		W134D12	82679	CABLE POWER.ELECTRICAL	EA	1
115	16	PAFZZ	5935-00-493-6288	NS3106A1655C	02660	CONNECTOR,PLUG,ELECTRICAL	EA	1
115	17	PAFZZ		P1160	FL218	82679 CONNECTOR,PLUG,ELECTRICAL	EA	1
						GROUP 1509 POWER CABLE ASSEMBLIES		
116	1	PAFZZ	5935-00-813-0620	2127GA	79725	CONNECTOR,RECSP,ELECTRICAL	EA	4
116	2	PAFZZ	S995-00-956-4398	17106	70903	CABLE,POWER	EA	18
116	3	PAFZZ	5935-00-257-6397	74108	74545	CONNECTOR,RECEP,ELECTRICAL	EA	1

SECTION II. REPAIR PARTS LIST

TM 11-5895-288-24P

(1) ILLUSTRATION		(2)	(3)	(4)	(5)	(6)	(7)	(8)
(a) FIG NO.	(b) ITEM NO.	SMR CODE	NATIONAL STOCK NUMBER	PART NUMBER	FSCM	DESCRIPTION USABLE ON CODE	U/M	QTY INC IN UNIT
117	1	PAFZZ	5940-00-836-8557	21-164	71785	GROUP 1510 TERMINAL BARRIER,KW-7 RACK BARRIER,TERMINAL GROUP 1511 RADIO FREQUENCY CABLE ASSEMBLY CG-1040B/U	EA	1
118	1	PAFFF	5995-00-933-5802	SNC531001	80063	CABLE ASSEMBLY RADIO FREQUENCY F	EA	1
118	2	PAFFF	5995-00-221-9450	SMC531001	80063	CABLE ASSEMBLY RADIO FREQUENCY 20 n	EA	1
118	3	PAFFF	5995-00-933-5801	SNCS31001	80063	CABLE ASSEMBLY RADIO FREQUENCY 3 FT	EA	1
118	4	PAFFF	5995-00-933-5800	SKC531001	80063	CABLE ASSEMBLY RADIO FREQUENCY 4 FT	EA	1
118	5	PAFFF	5995-00-913-0509	SNC531001	80063	CABLE ASSEMBLY RADIO FREQUENCY 5 FT	EA	1
118	6	PAFFF	5995-00-935-5289	SKCC531001	80063	CABLE ASSEMBLY RADIO FREQUENCY 6 FT	EA	1
118	7	PAFZZ	5935-00-850-9157	M39012-16-0002	81349	CONNECTOR,PLUG.ELECTRICAL	EA	2
118	8	PAFFZ	5935-00-451-2449	M39012-25-0003	81349	COVER,ELECTRIC CONNECTOR	EA	2
						GROUP 1512 LOOSE CABLES AND CONNECTORS		
119	1	PAFZZ	6145-006-11-0887	RG8U	96906	CABLE,RADIO FREQUENCY	FT	98
119	2	PAFZZ	6145-00-161-0885	RG11AU	96906	CABLE,RADIO FREQUENCY	FT	96
119	3	PAFZZ	5935-00-149-4236	UG21BU	82679	CONNECTOR,PLUG,ELECTRICAL	EA	4
119	4	PAFZZ	5935-00-660-4302	UGS73BU	82679	CONNECTOR,PLUG,ELECTRICAL	EA	2
119	5	PAFZZ	5935-00-186-9860	PL150	61349	CONNECTOR,PLUG,ELECTRICAL	EA	4
119	6	PAFZZ	5935-00-404-7965	50-239	81349	CONNECTOR,RECEP.ELECTRICAL	EA	8
119	7	PAFZZ	5935-00-501-7594	UG96AU	96906	CONNECTOR,ECCEP,ELECTRICAL	EA	4
						GROUP 1513 PATCH CORDS,TEST LEADS AND LOOSE CONNECTORS		
119	8	PAFZZ	6625-00-668-6900	A622602	91820	LEAD TEST	EA	2
119	9	PAFZZ	6625-00-668-6892	A632	91820	LEAD TEST	EA	2
119	10	PAFZZ	662-00-668-6899	A622-601	91820	LEAD TEST	EA	2
119	11	PAFZZ	5995-00-076-2357	P2AA	26042	CORD ASSEMBLY,ELECTRICAL	EA	8
119	12	PAFZZ	5995-00-170-6887	PJ0558	80063	CORD ASSEMBLY,ELECTRICAL	EA	8
119	13	PAFZZ	5995-00-727-1513	PJO55	81349	CORD ASSEMBLY ELECTRICAL	EA	1
119	14	PAFZZ	5995-00-283-8457	PL04	80063	PATCH CORD ELECTRICAL	EA	2
119	15	PAFZZ	5995-00-725-5848	PJ055	81349	CORD ASSEMBLY.ELECTRICAL	EA	3
119	16	PAFZZ	5935-00-149-4236	UG218U	82679	CONNECTOR,PLUG,ELECTRICAL	EA	4
119	17	PAFZZ	5935-00-660-4302	U65738U	82679	CONNECTOR,PLUG.ELECTRICAL	EA	2
119	18	PAFZZ	5935-00-186-9868	PL150	81349	CONNECTOR,PLUG.ELECTRICAL	EA	4
119	19	PAFZZ	5935404-7965	S0-239	81349	CONNECTOR,RECEP,ELECTRICAL	EA	10
119	20	PAFZZ	5935-00-501-7594	UG96AU	82679	CONNECTOR,RECEP,ELECTRICAL	EA	4
119	21	PAFZZ	5935-192-4774	347A	82679	PLUG,TELEPHONE	EA	16
119	22	PAFZZ	5935-192-4882 2418		64959	PLUG,TELEPHONE	EA	16

SECTION II. REPAIR PARTS LIST

TM 11-5895-288-24P

(1) ILLUSTRATION		(2)	(3)	(4)	(5)	(6)	(7)	(8)
(a) FIG NO.	(b) ITEM NO.	SMR CODE	NATIONAL STOCK NUMBER	PART NUMBER	FSCM	DESCRIPTION USABLE ON CODE	U/M	QTY INC IN UNIT
BULK		PAFZZ	6145-00-161-0885	R611AU	9690t	GROUP 1515 BULK CABLES		
BULK		PAFZZ	6145-00-161-0087	R6BU	96906	CABLE,RADIO FREQUENCY	FT	100
BULK		PAFZZ	6145-00-161-0913	R662AU	96906	CABLE,RADIO FREQUENCY	FT	100
BULK		PAFZZ	6145-00-161-0913	R662AU	96906	CABLE ASSEMBLY,RADIO FREQUENCY	EA	1
BULK		PAFZZ	6145-00-542-6092	R65SCU	96906	CABLE,RADIO FREQUENCY	EA	1
					94			

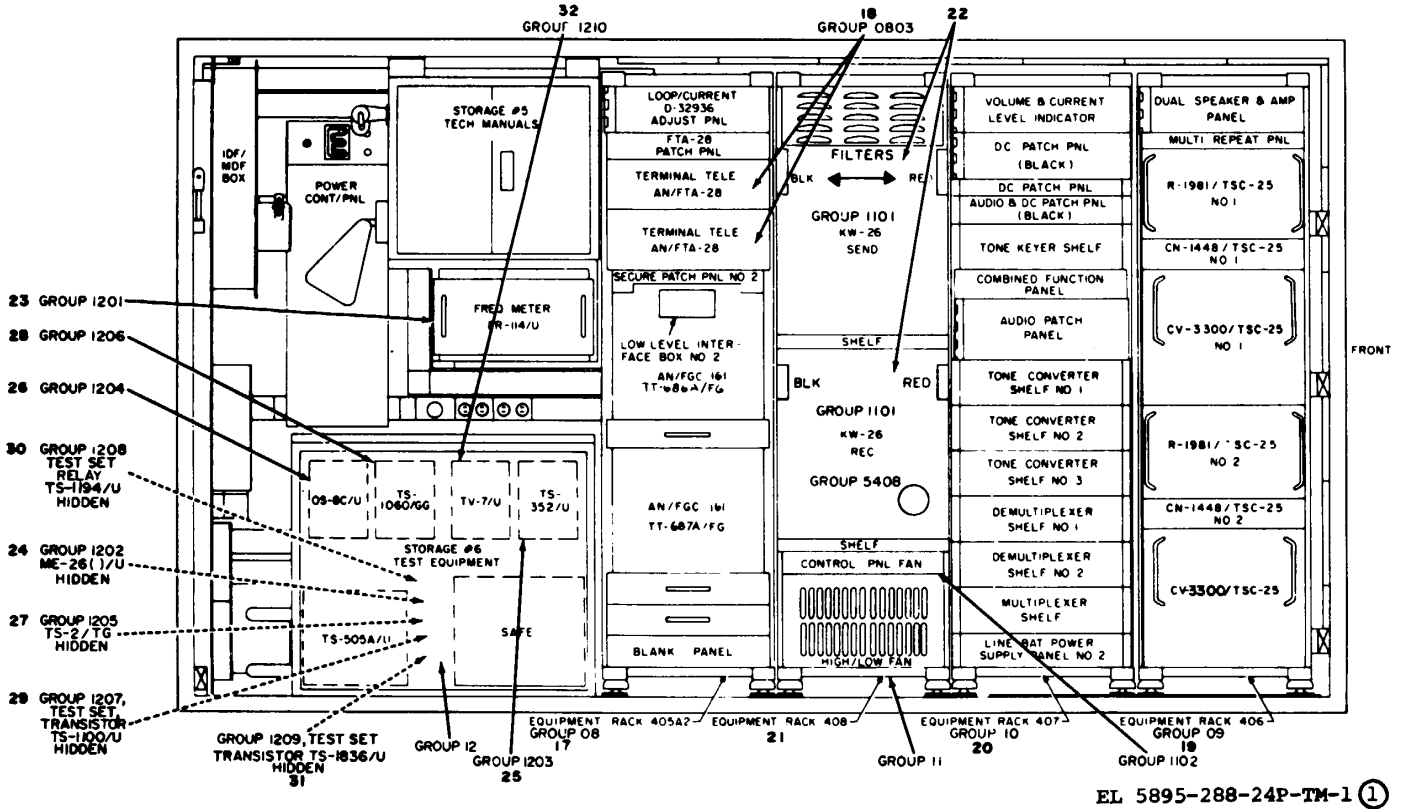

EL 5895-288-24P-TM-1 ①

Figure 1. Communications Central AN/TSC-25 (Sheet 1 of 2)

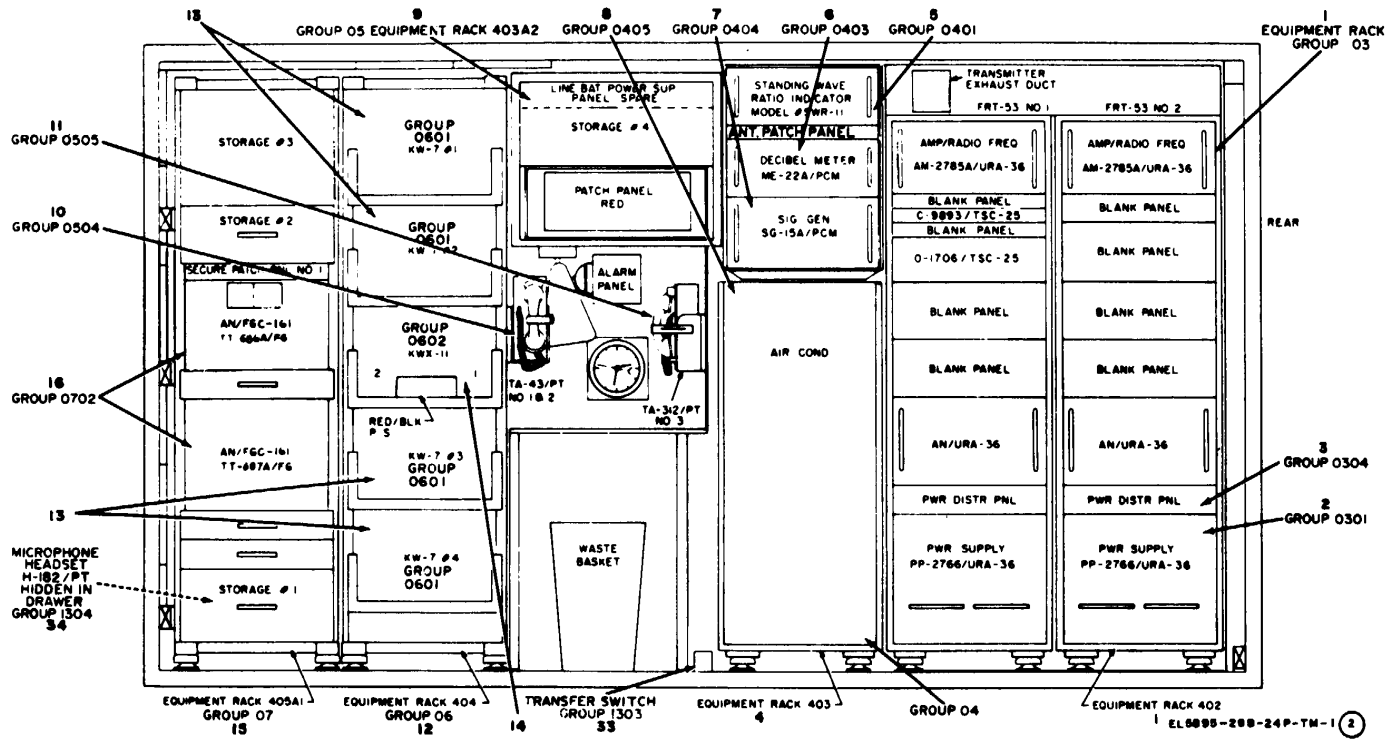

Figure 1. Communications Central AN/TSC-25 (Sheet 2 of 2)

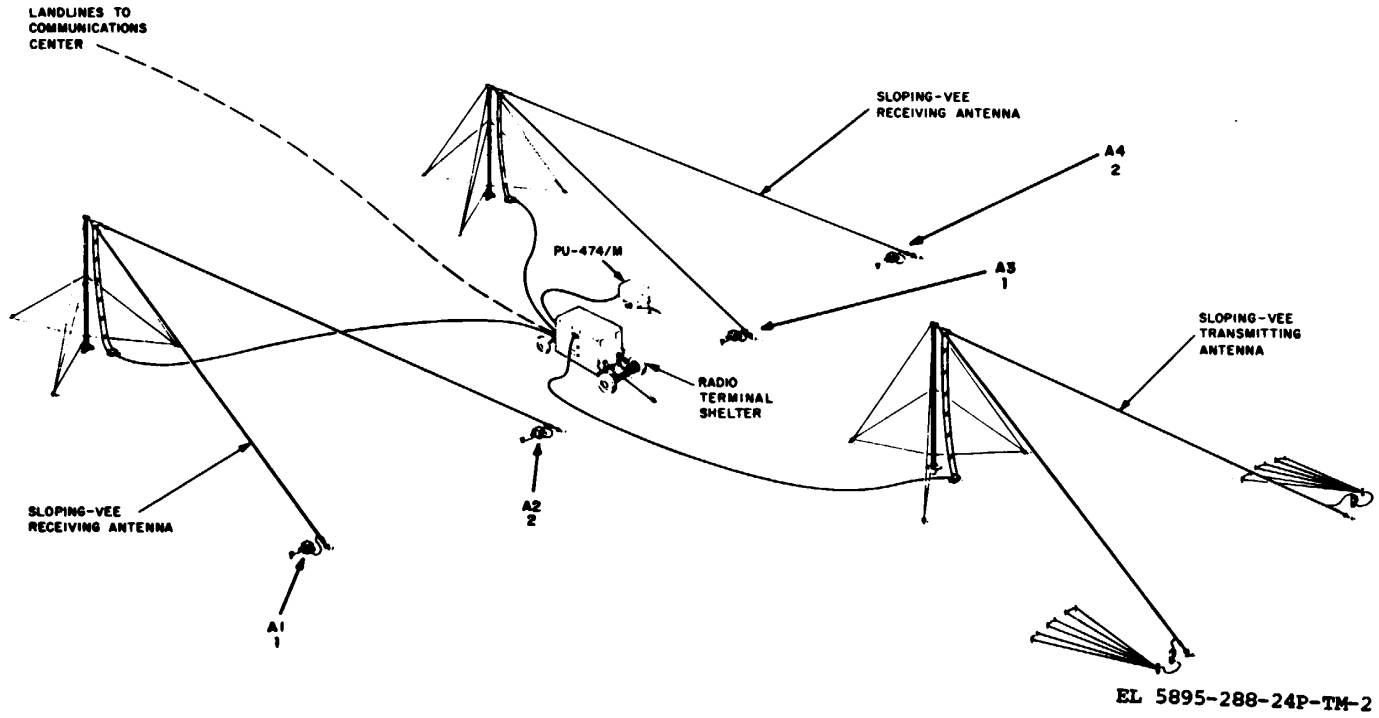

Figure 2. High Frequency Antenna System

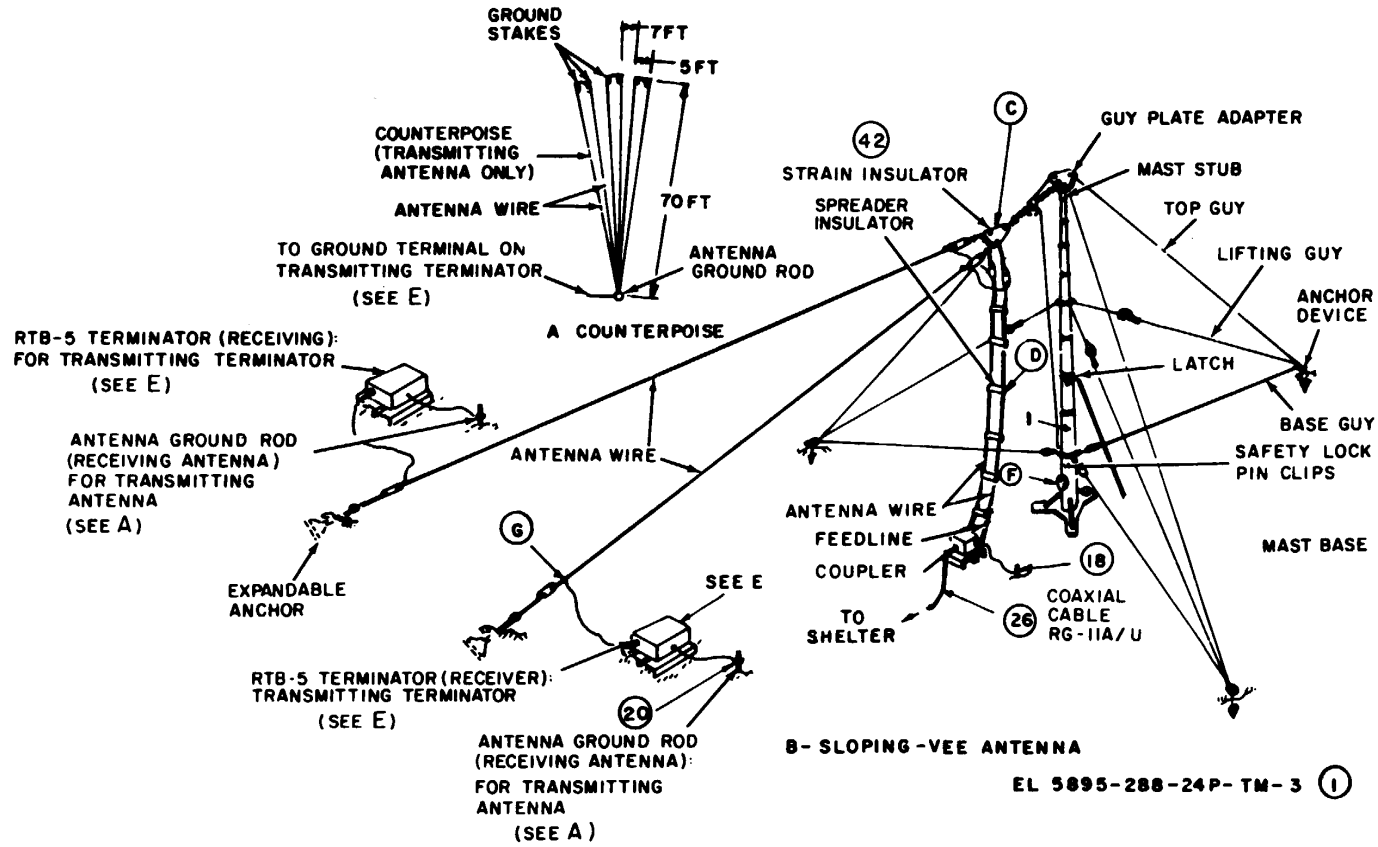
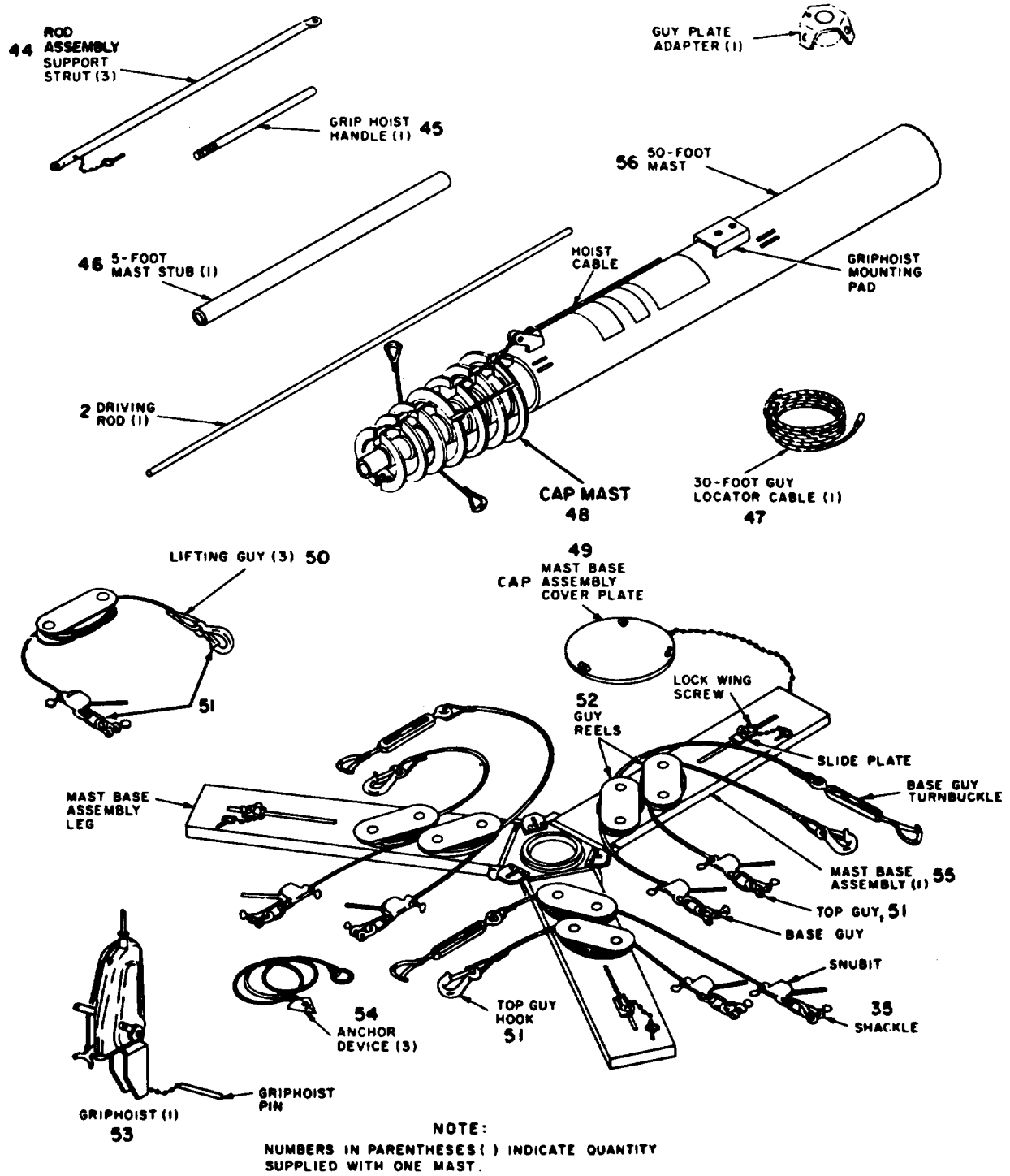
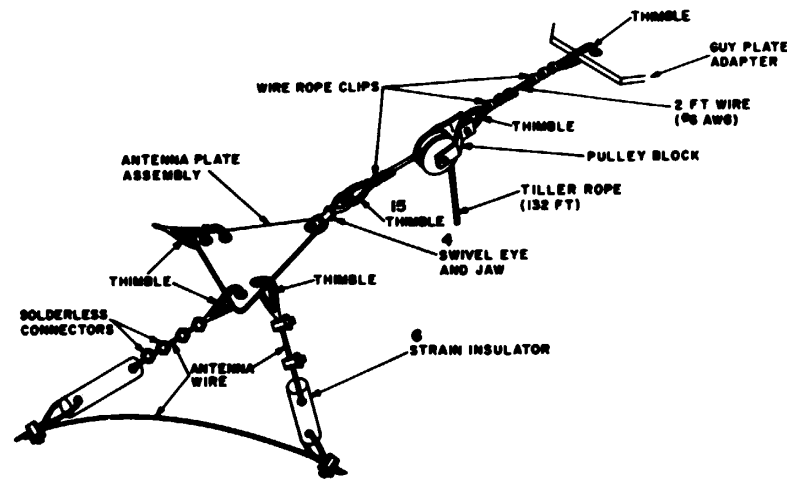

Figure 3. Antenna Mast- AB-746/G (Sheet 1 of 4)



EL 5895-288-24P-TM-3 (2)

Figure 3. Antenna Mast AB-746/G (Sheet 2 of 4)



C. PULLEY BLOCK AND ANTENNA PLATE ASSEMBLY

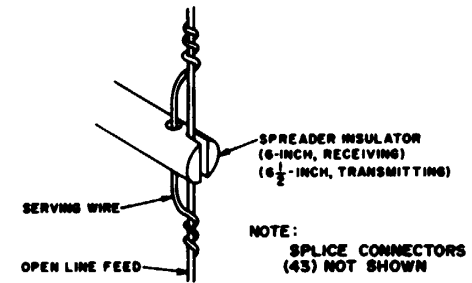

D. SPREADER INSULATOR

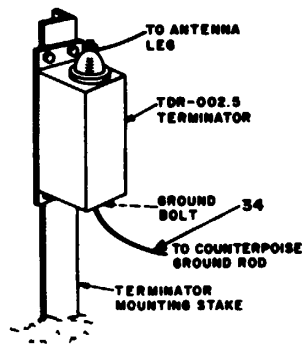

E. TRANSMITTING TERMINATOR TDR-002.5

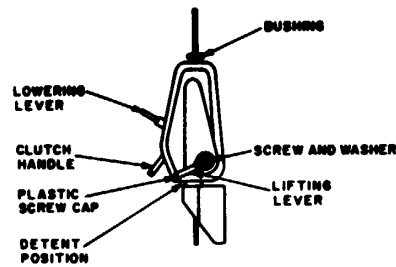

F. GRIPHOIST

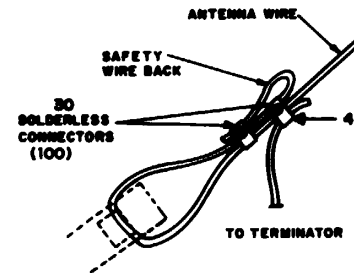

G. TYPICAL CONNECTION FOR SOLDERLESS CONNECTOR

EL 5895-288-24P-TM-3 (3)

Figure 3. Antenna Mast AB-746/G (Sheet 3 of 4)

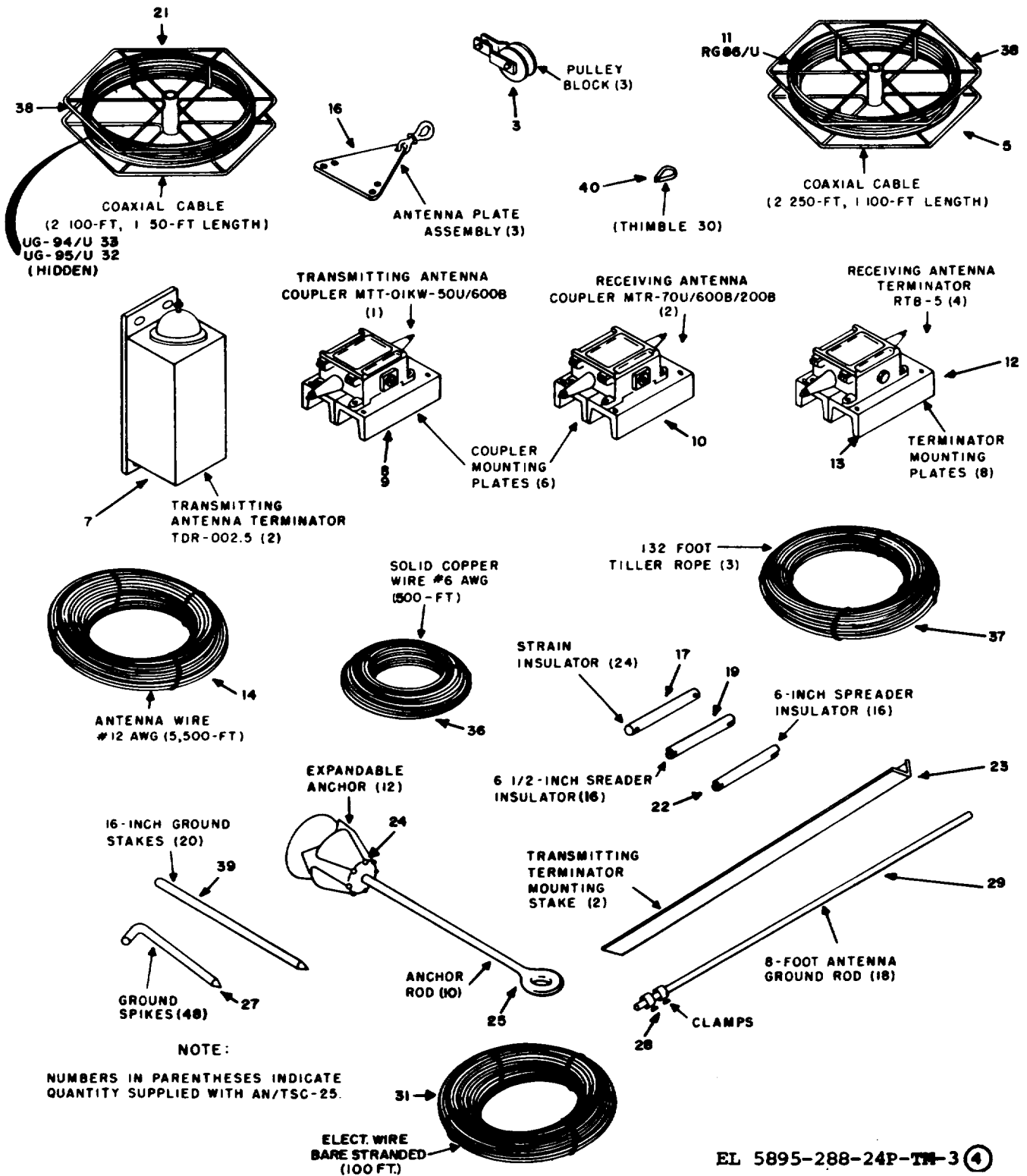
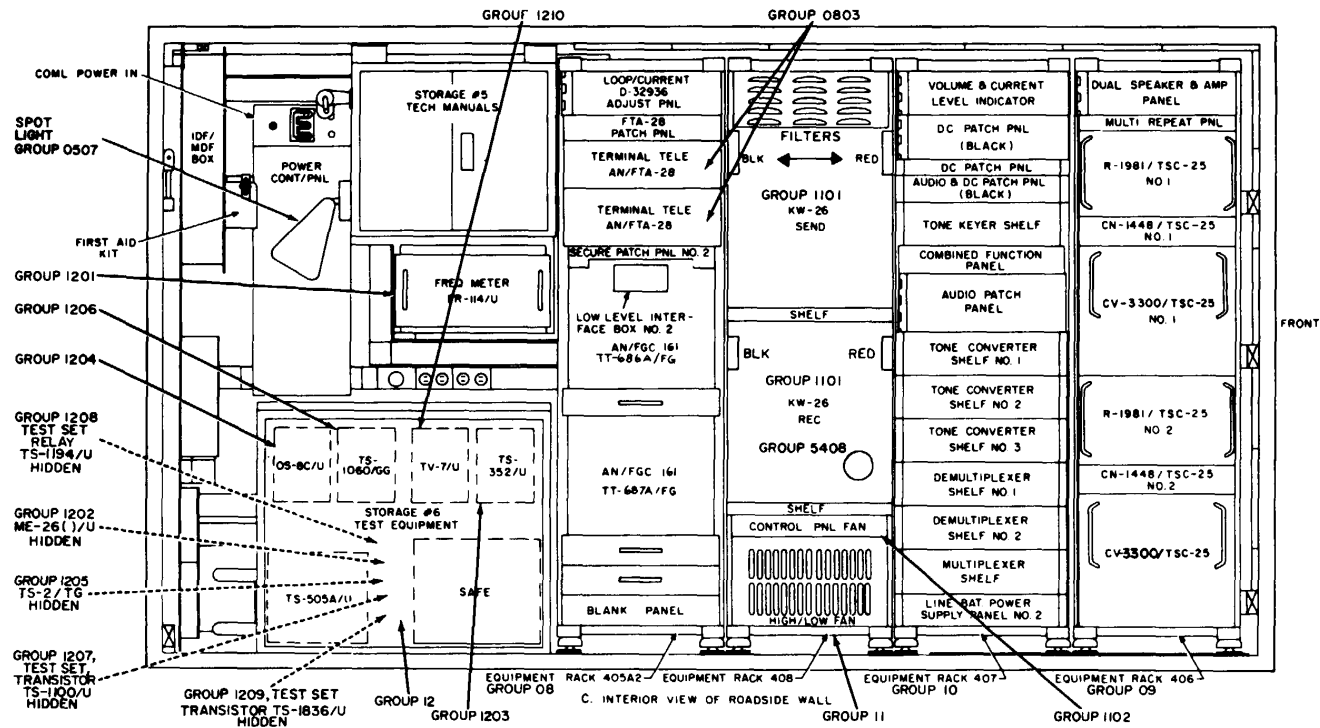
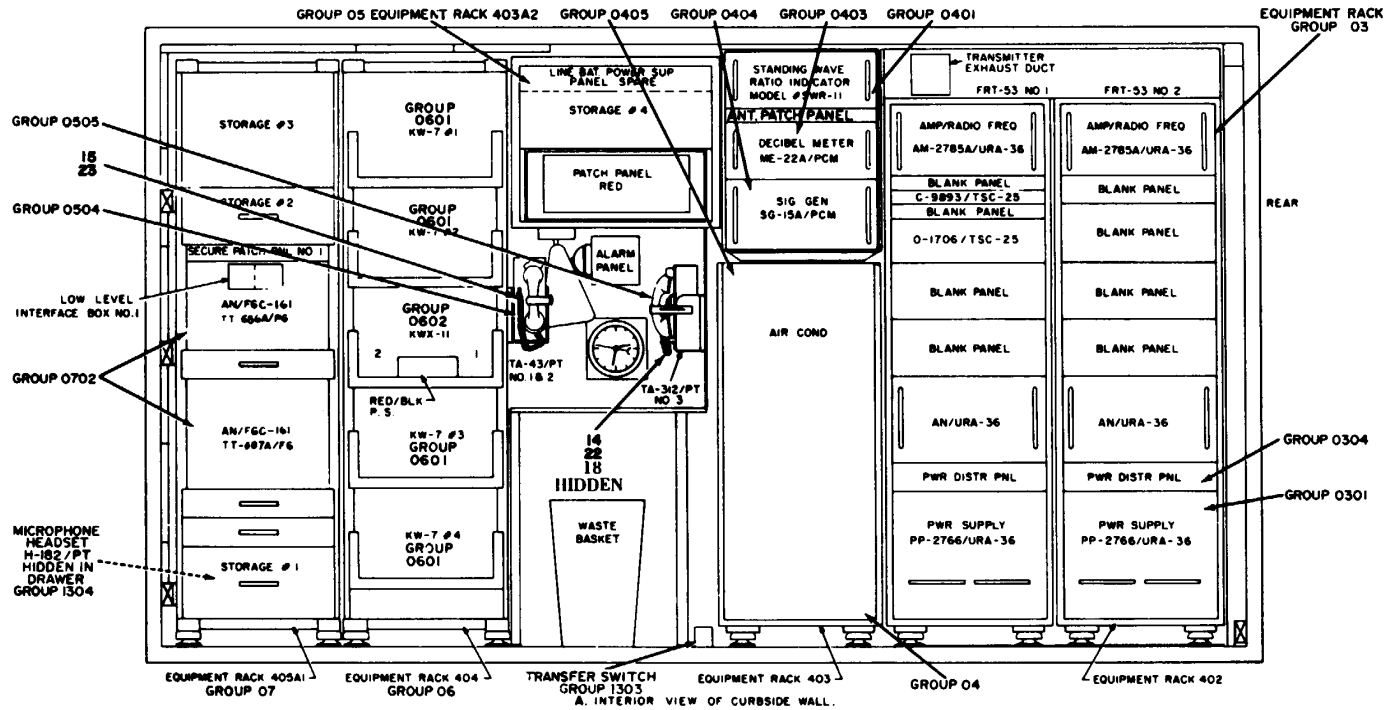

Figure 3. Antenna Mast AB-746/G (Sheet 4 of 4)



EL 5895-288-24P-TM-4 ①

Figure 4. Electrical Equipment Shelter (Sheet 1 of 4)



EL 5895-288-24P-TM-4 (2)

Figure 4. Electrical Equipment Shelter (Sheet 2 of 4)

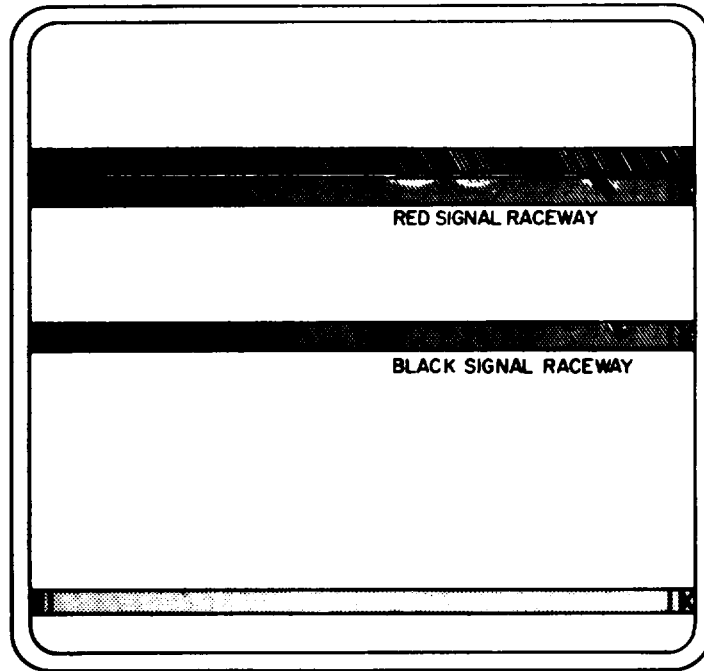

A. INTERIOR VIEW OF FRONT WALL

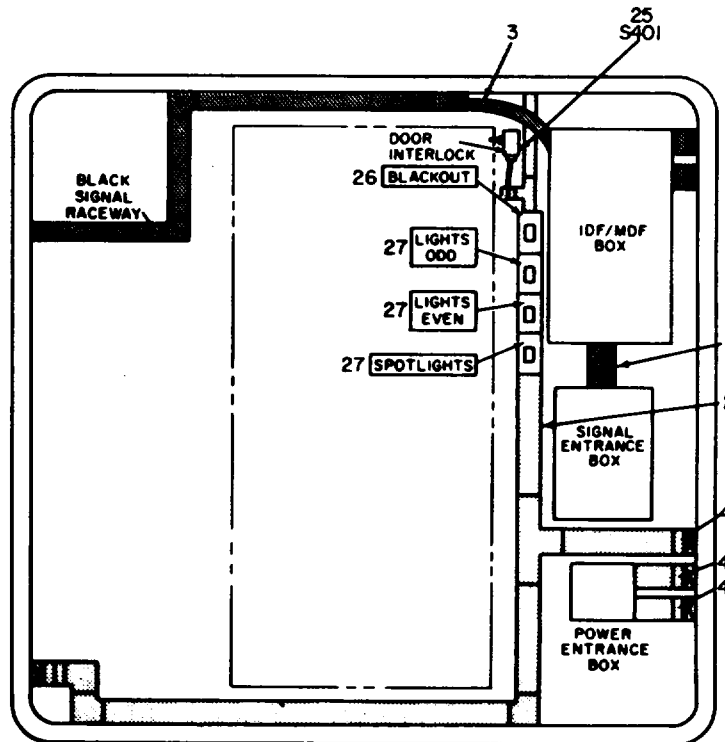

C. INTERIOR VIEW OF REAR WALL

EL 5895-288-24P-TM-4 (3)

Figure 4. Electrical Equipment Shelter (Sheet 3 of 4)

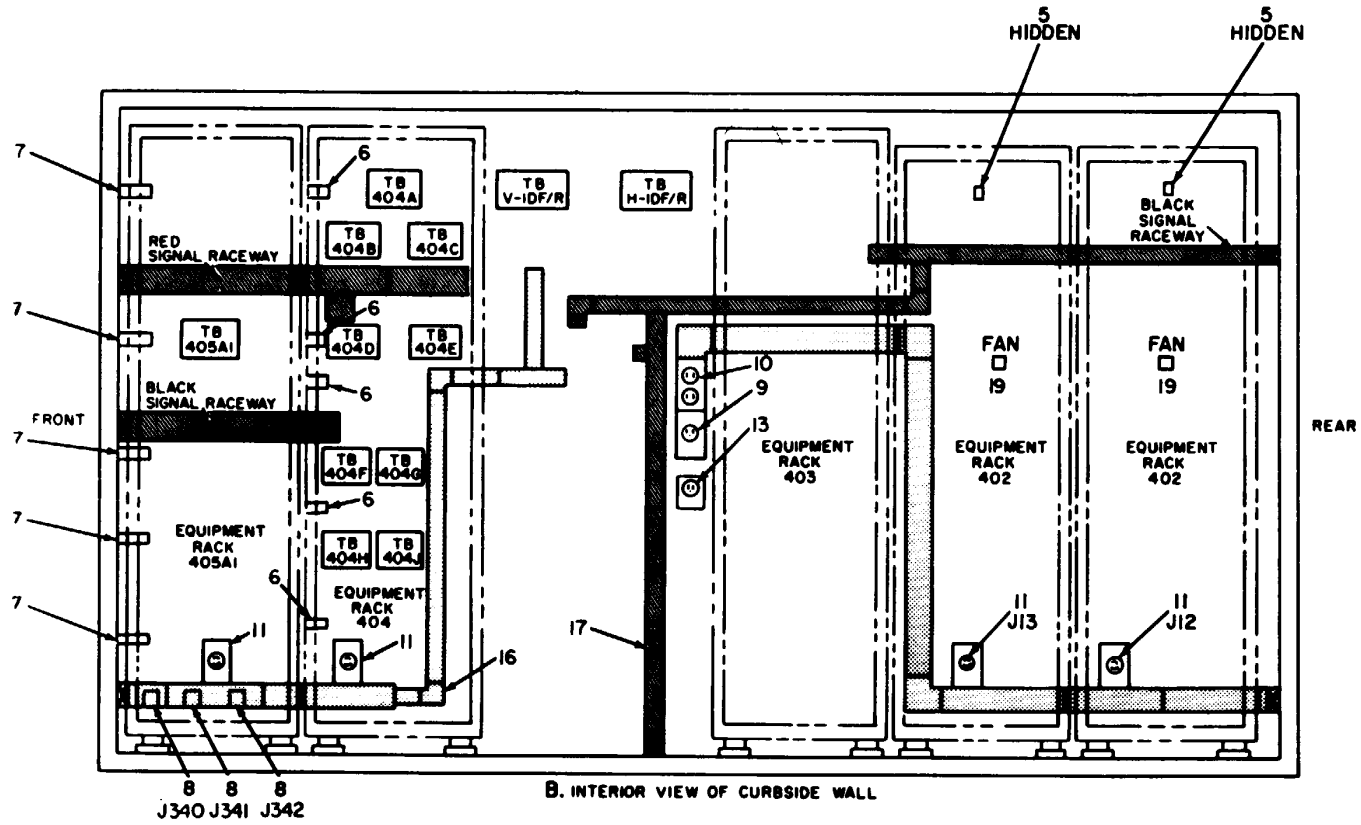

EL 5895-288-24P-TM-4 ④

Figure 4. Electrical Equipment Shelter (Sheet 4 of 4)

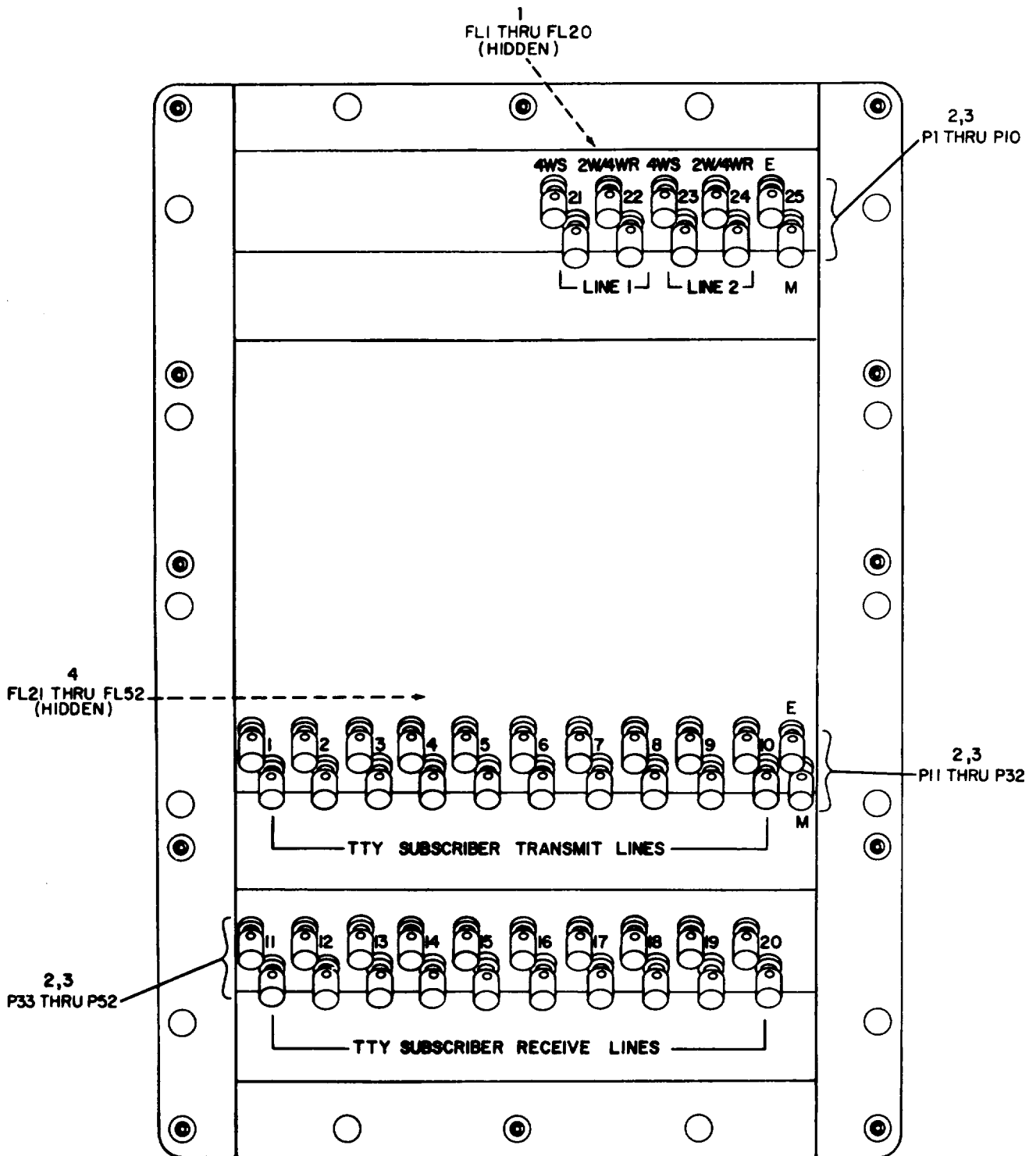

EL 5895-288-24P-TM-5

Figure 5. Signal Entrance Box

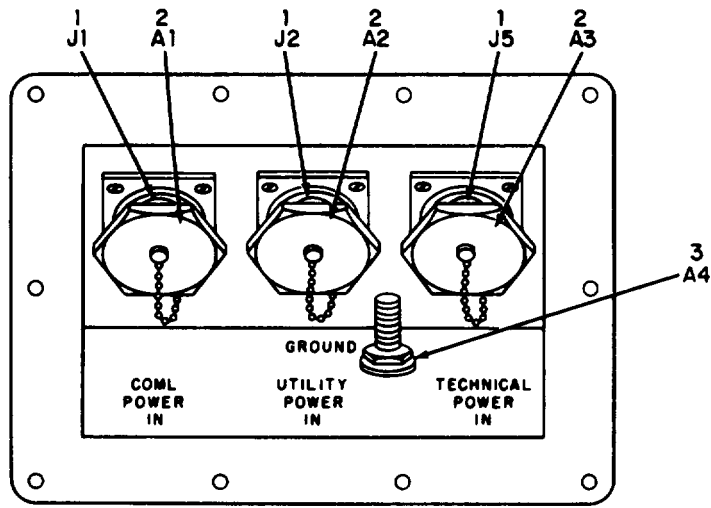

EL 5895-288-24P-TM-6

Figure 6. Power Entrance Box

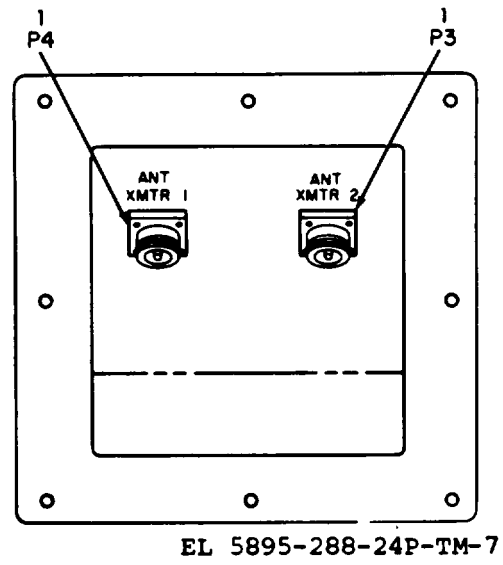

Figure 7. HF Transmitting Entrance Box

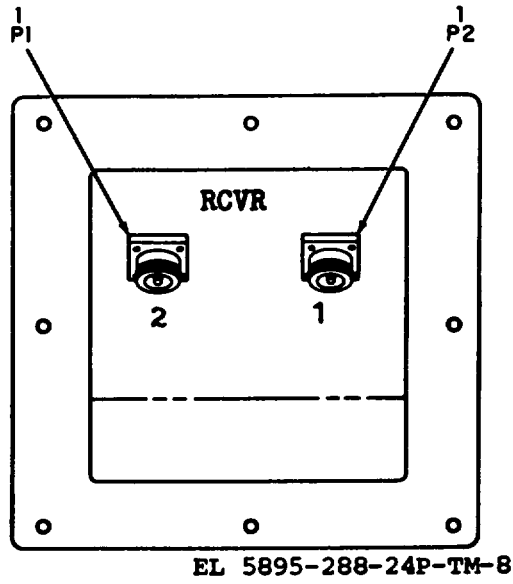

Figure 8. HF Receiving Entrance Box

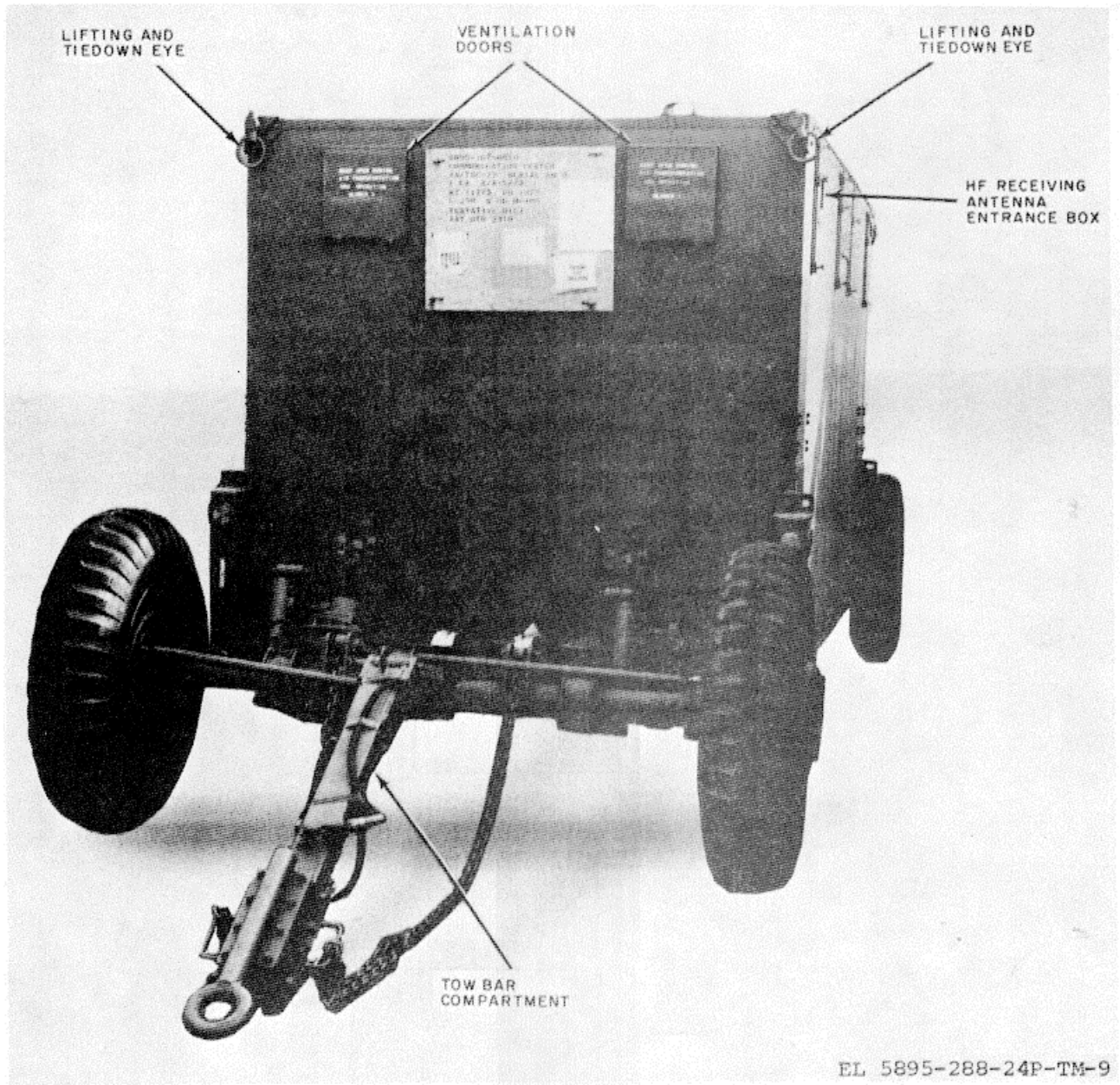

Figure 9. Transportable Shelter Dolly Set Lift

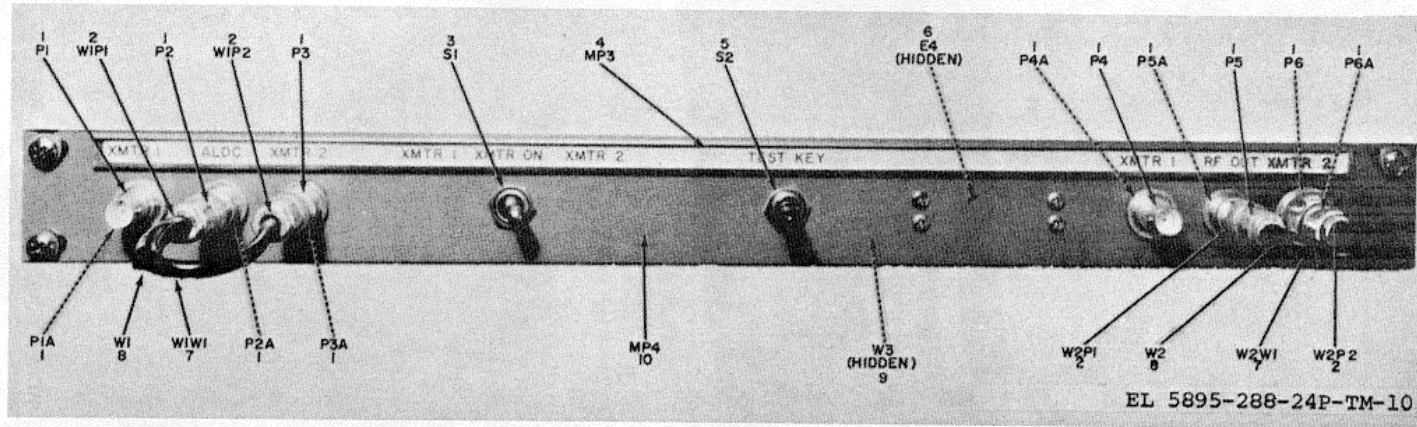
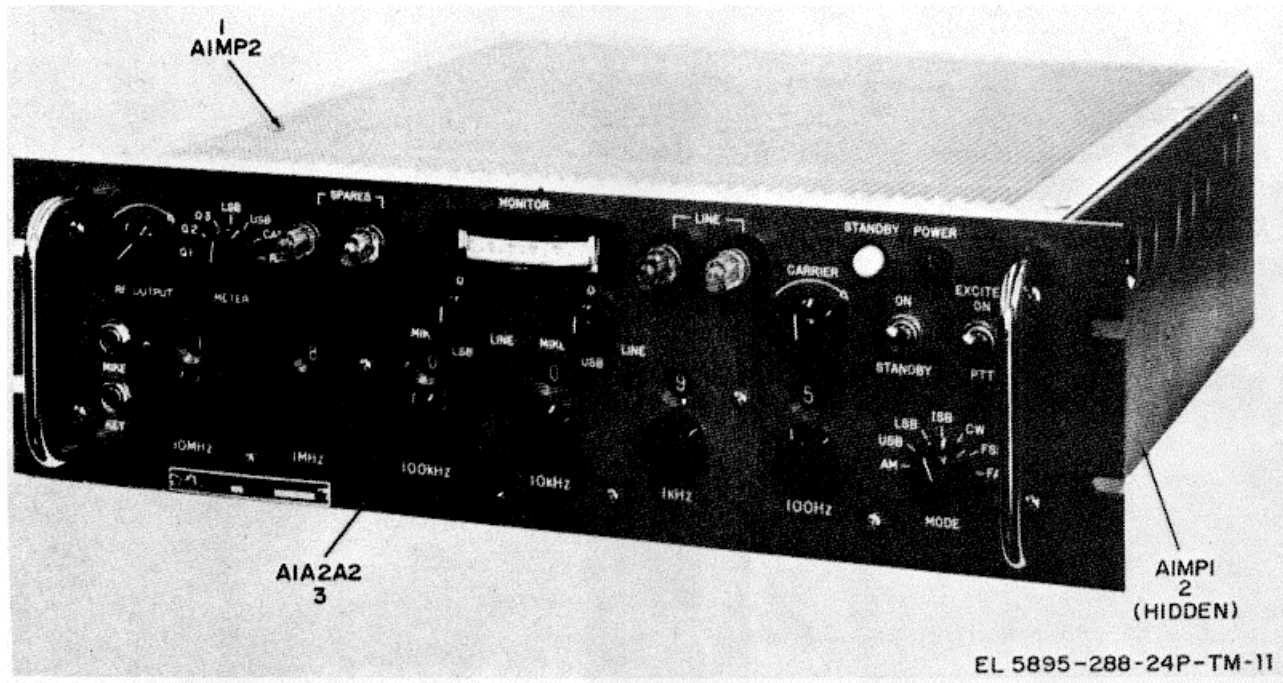

Figure 10. Control Transmitter C-9893/TSC-25



EL 5895-288-24P-TM-11

Figure 11. Radio Frequency Oscillator 0-1706/TSC-25

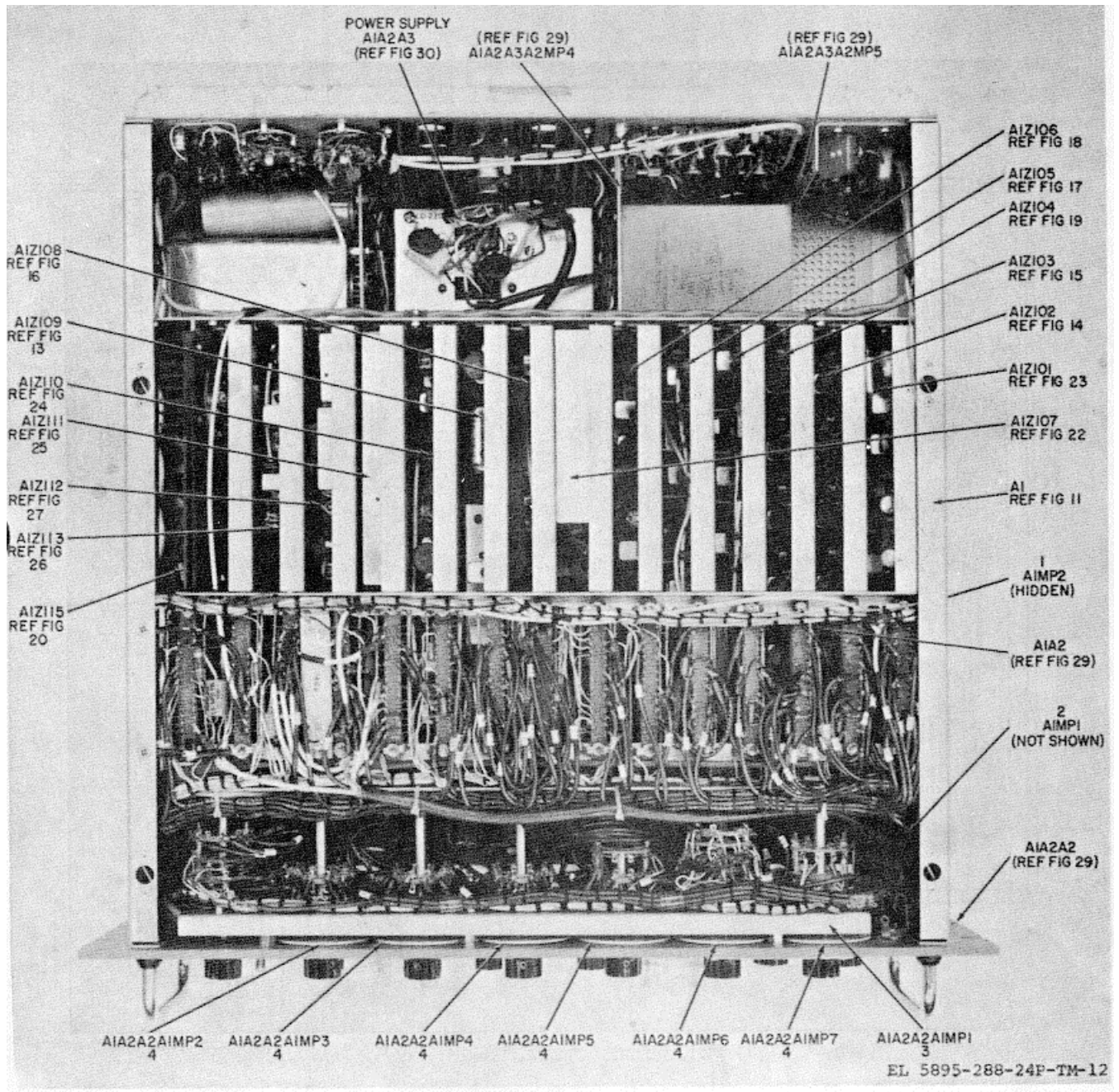
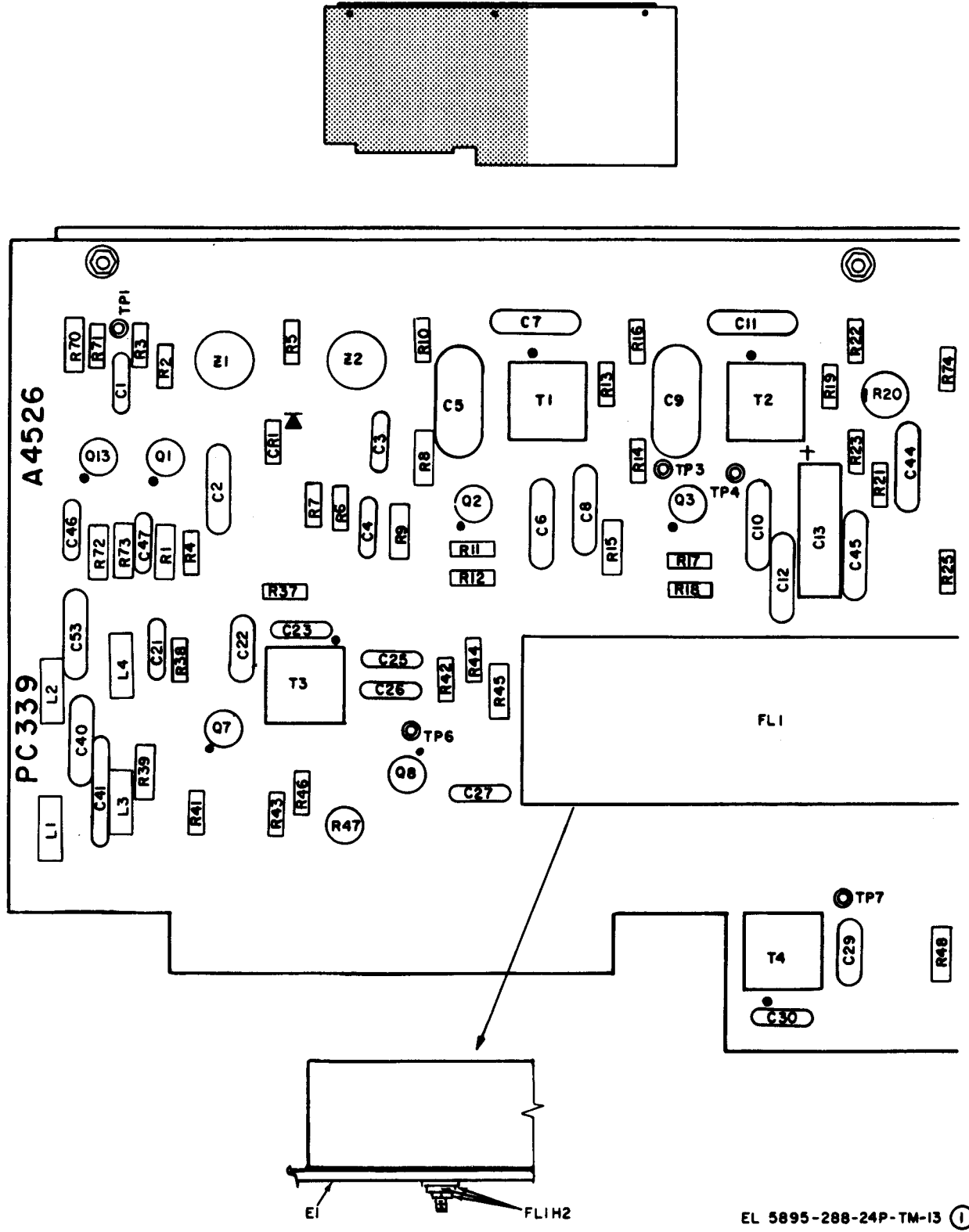

Figure 12. Multimode Exciter BMA-106



EL 5895-288-24P-TM-13 (1)

Figure 13. Carrier Generator Circuit Card Z109 (Sheet 1 of 2)

Section II. REPAIR PARTS LIST

TM 11-5895-288-24P

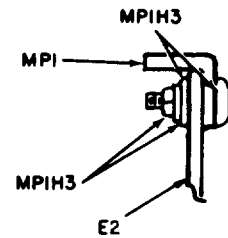
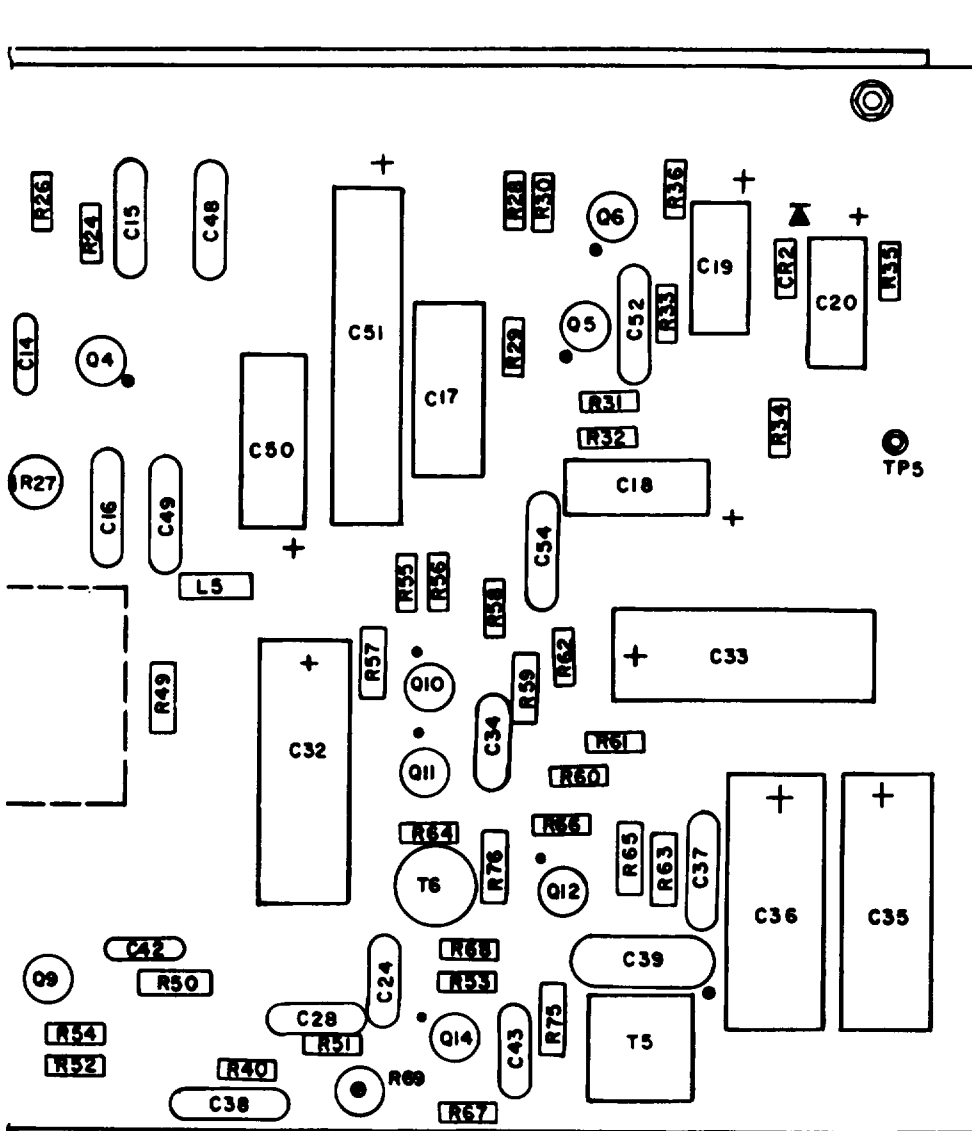
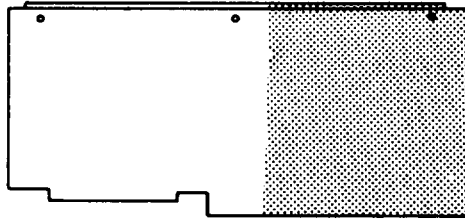

EL 5895-288-24P-TM-13 (2)

Figure 13. Carrier Generator Circuit Card Z109 (Sheet 2 of 2)

Section II. REPAIR PARTS LIST

KEY to fig. 13:

Index	Ref Des	Index	Ref Des	Index	Ref Des
1	R70	32	R29		
2	R19,R57,R71,R75	33	R33,R39,R50		
3	C1,C3,C4,C14,C21, C23,C24,C25,C26, C28,C30,C34,C43, C52	34	C19,C20		
4	TP1,TP3,TP4,TP5, TP6,TP7	35	FLIH2,MPIH3		
5	R3,R4,RO1,R12,R16, R18,R22,R23,R26, R37,R44,R45,R52, R65,R72	36	FL1H2,MP1H3		
6	R2,R24	37	FL1H2,MP1H3		
7	Z1,Z2	38	MP1		
8	CR1	39	MP1H3		
9	R6,R7,R21,R74	40	E2		
10	R5	41	CR2		
11	RI,R9,R15,R25,R34, R35,R43,R55,R66	42	R41,R46,R54,R58, R60		
12	R8,R14,R38,R48	43	R59		
13	C5,C9,C39	44	R40,R61		
14	Q1,Q2,Q3,Q4,Q5,Q6, Q7,Q8,Q9,Q10,Q11, Q12,Q13,Q14	45	R63		
15	C2,C6,C7,C8,C10, C11,C12,C15,C16, C37,C38,C40,C41, C48,C49,C53,C54	46	T5		
16	T1	47	R68		
17	T1	48	R53		
17A	T2	49	T6		
17B	T5	50	R64		
18	RII,R13,R17,R31, R36,R67	51	R69		
19	T2	52	R51,R73		
20	C13	53	C27,C42		
21	C44,C45	54	C22,C29		
22	R20	55	T4		
23	R27	56	T3,T4		
24	R32,R49	57	EI		
25	C50	58	FL1		
26	C51	59	R47		
27	L1,L3,L5	60	T3		
28	C32,C33,C35,C36	61	L3,L4		
29	C17,C18	62	C46,C47		
30	R28,R42				
31	R30,R56,R62,R76				

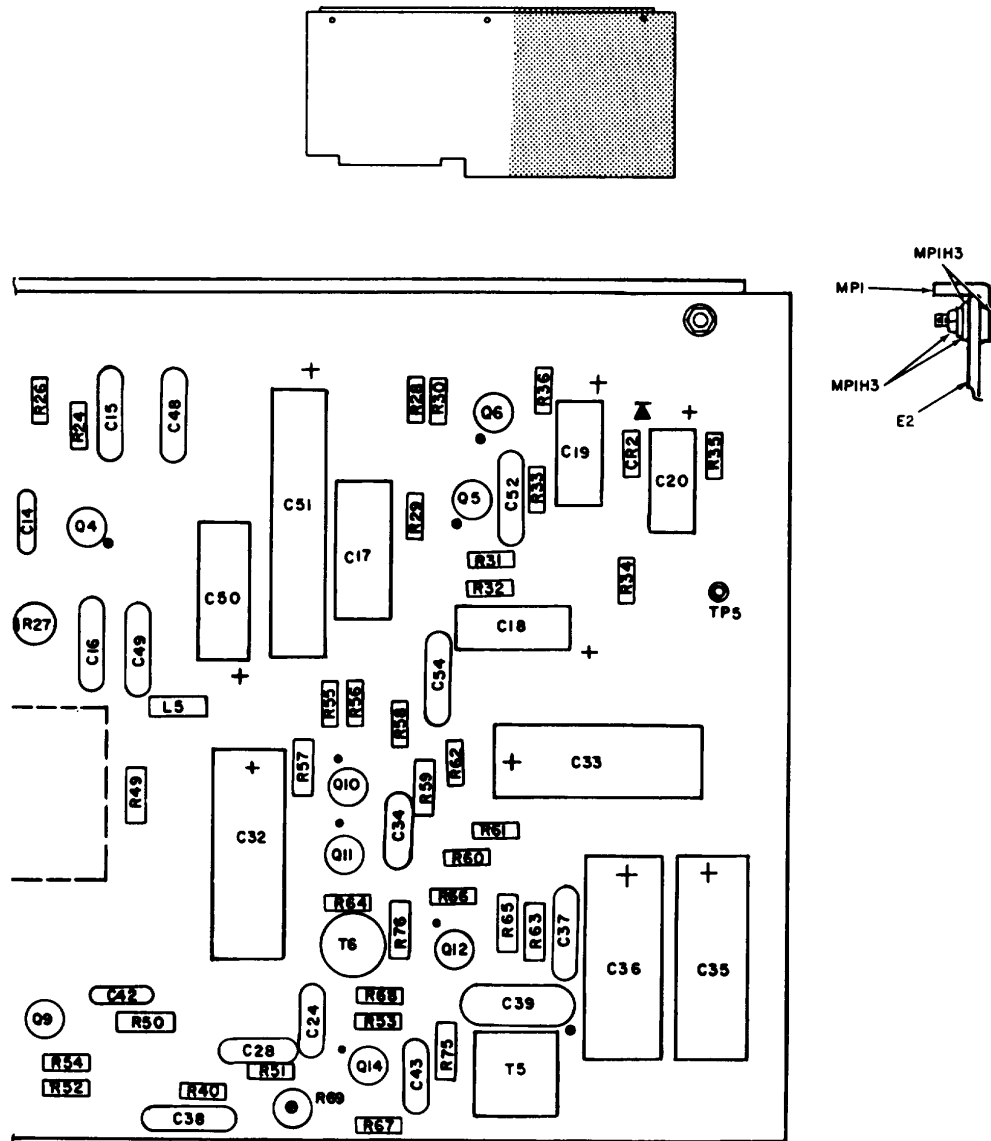

EL 5895-288-24P-TM-13 (2)

Figure 14. Comb Filter A Circuit Card Z102

SECTION II. REPAIR PARTS LIST

KEY to fig. 14:

Index	Ref Des	Index	Ref Des	Index	Ref Des
1	R6,R9,R16,R23,R30, R37	24	Y6		
2	R43,R44,R45,R46, R47,R48	25	MP1H3		
3	R7,R8,R15,R22,R29, R36,R49,R50,R51, R52,R53,R54	26	MP1H3		
4	R5,R10,R17,R24, R31,R38	27	MP1H3		
5	Y1	28	MP1		
6	Y1,Y2,Y3,Y4,Y5,Y6	29	MP1H3		
7	C1,C5,C6,C7,C9,C13, C15,C16,C18,C23, C24,C26,C28,C33, C34,C36,C37,C38, C44,C45,C47,C48, C50,C55,C56,C58, C59,C61,C66	30	EI		
8	C2,C8,C14,C17	31	C57,C60		
9	Y2	32	T9,T10,T11,T12		
10	TP1,TP2,TP3,TP4, TP5,TP6,TP7,TP8, TP9,TP10,TP11, TP12	33	T1,T2,T3,T4,T5, T6,T7,T8,T9,T10, T11,T12		
11	C67,C68,C69,C70, C71,C72	34	R3,R14,R21,R28, R35,R42		
12	C73,C74,C75,C76, C77,C78	35	L1,L2,L3,L4,L5, L6,L7,L8,L9,L10, L11,L12		
13	Q1,Q2,Q3,Q4,Q5,Q6, Q7,Q8,Q9,Q10,Q11, Q12	36	R2,R13,R20,R27, R34,R41		
14	C10,C11,C22,C32,C43, C54	37	T7,T8		
15	R4,R11,R18,R25,R32, R39	38	T3,T4,T5,T6		
16	C25,C27	39	T1,T2		
17	Y3				
18	R1,R12,R19,R26,R33, R40				
19	C4,C19,C21,C30,C31, C41,C42,C52,C53,C63, C64,C65				
20	Y4				
21	C35,C40,C46,C49				
22	C3,C20,C29,C39,C51, C62				
23	Y5				

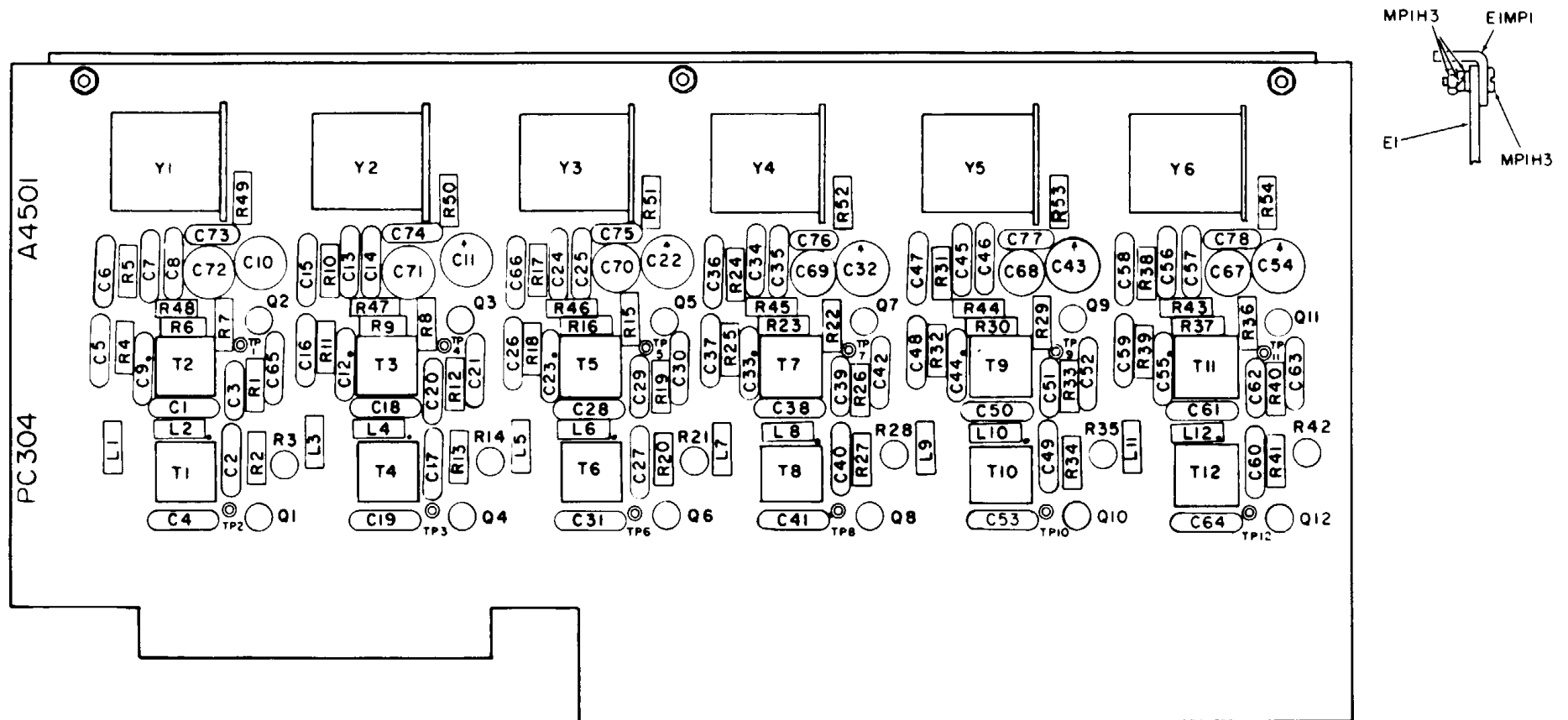

Figure 15. Comb. Filter B Circuit Card Z103

SECTION II. REPAIR PARTS LIST

KEY to fig. 15:

Index	Ref Des	Index	Ref Des	Index	Ref Des
1	R6,R9,R16,R23, R30, R37	23	C46,C49,C57,C60		
2	R43,R44,R45,R46,R47, R48	24	Y6		
3	R7,R8,R15,R22,R29, R36,R49,R50,R51, R52, R53, R54	25	MP1H3		
4	R5,R10,R17,R24, R31,R38	26	MP1H3		
5	Y1	27	MP1H3		
6	Y1,Y2,Y3,Y4,Y5,Y6	28	E1MP1		
7	C1,C5,C6,C7,C9, C12,C13,C15,C16, C18,C23,C24,C26, C28,C33,C34,C36, C37,C38,C44,C45, C47,C48,C50,C55, C56,C58,C59,C61, C66	29	MP1H3		
8	C14,C17	30	E1		
9	Y2	31	TII,T12		
10	TP1,TP2,TP3,TP4, TP5,TP6,TP7,TP8, TP9,TP10,TPI1,TP12	32	T1,T2,T3,T4,T5, T6,T7,T8,T9,T10, TII,T12		
11	C67,C68,C69,C70, C71,C72	33	R3,R14,R21,R28, R35,R42		
12	C73,C74,C75,C76,C77, C78	34	L1,L2,L3,L4,L5,L6, L7,L8,L9,L10,LII, L12		
13	Q1,Q2,Q3,Q4,Q5,Q6, Q7,Q8,Q9,QIO,QII, Q12	35	R2,R13,R20,R27,R34, R41		
14	C10,CII,C22,C32, C43,C54	36	T7,T8,T9,T10		
15	R4,RII,R18,R25,R32, R39	37	T5,T6		
16	C25,C27,C35,C40	38	T1,T2,T3,T4		
17	Y3	39	C8		
18	RI,R12,RI9,R26,R33, R40				
19	C4,C19,C21,C30,C31, C41,C42,C53,C59,C63, C65,T12				
20	Y4				
21	C3,C20,C29,C35,C39, R40				
22	Y5				

SECTION II. REPAIR PARTS LIST

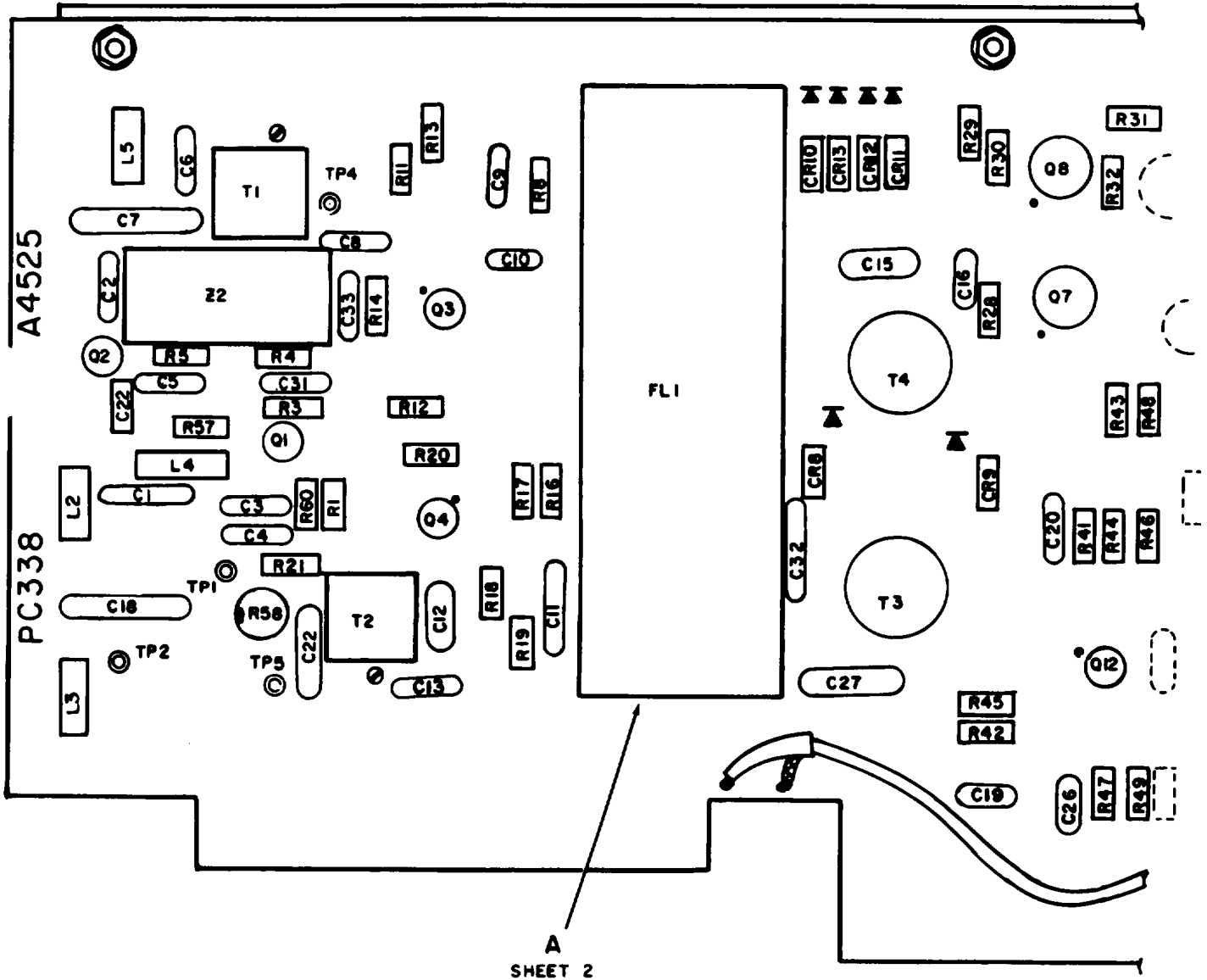
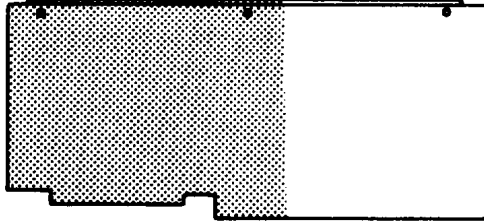

EL 5895-288-24P-TM-16 ①

Figure 16. Frequency Shift Generator Circuit Card Z108 (Sheet 1 of 2)

SECTION II. REPAIR PARTS LIST

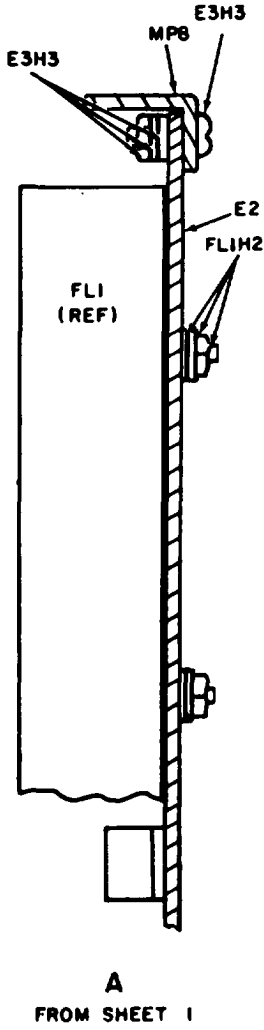
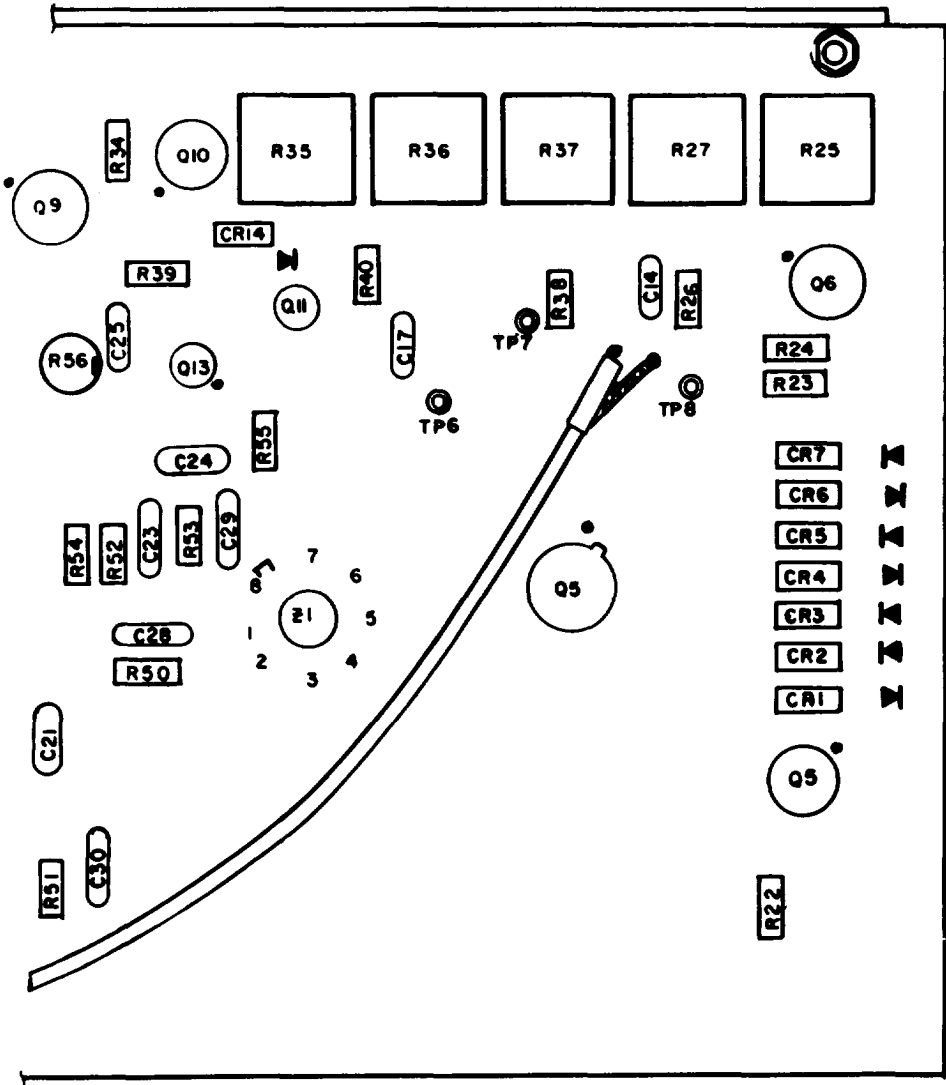
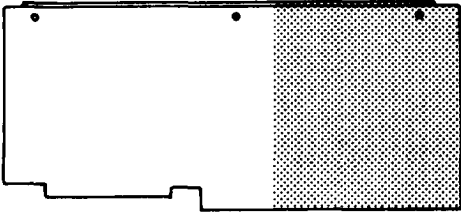

EL 5895 - 288 - 24P - TM - 16 (2)

Figure 16. Frequency Shift Generator Circuit Card Z108 (Sheet 2 of 2)

SECTION II. REPAIR PARTS LIST

KEY to fig. 16:

Index	Ref Des	Index	Ref Des	Index	Ref Des
1	C2,C3,C5,C7,C8, C9,C10,C11,C13, C19,C20,C21,C23, C24,C25,C26,C31, C33	40	Q7H1		
2	L4,L5	41	R23		
3	Z2	42	CR3,CR4,CR5,CR6, CR7		
4	C6,C12	43	CR1,CR2		
5	T1,T2	44	R22		
6	T1,T2	45	R48,R55		
7	R4	46	Z1		
8	TP1,TP2,TP4,TP5, TP6,TP7,TP8	47	C29		
9	R14,R20	48	RI,R18,R46,R50,R52, R53		
10	R11,R17	49	C22,C28,C30		
11	R13,RI9,R45,R54	50	W1		
12	Q1,Q2,Q3,Q4,Q12, Q13	51	R56		
13	R8,R21,R40,R43, R49, R60	52	R16,R44		
14	R12	53	R41,R42		
15	FL1	54	CR8,CR9		
16	CR10,CRI1,CR12, CR13	55	T3		
17	C15	56	T3H4		
18	R29,R30,R31,R32, R38	57	C27		
19	Q5,QS,Q9,Q10,Q11	58	T4		
20	C14,C16,C17	59	C1,C4,C18,C32		
21	R24,R26,R28,R47, R51	60	R58		
22	R34	61	L3		
23	Q6,Q7	62	L2		
24	R25,R35	63	R57		
25	R5,R39	64	R2		
26	CR14	65	R3		
27	R27,R36,R37	66	E2		
28	E3H3				
29	E3H3				
30	E3H3				
31	MP8				
32	E3H3				
33	E3H3				
36	FLIH1				
37	T3H1				

SECTION II. REPAIR PARTS LIST

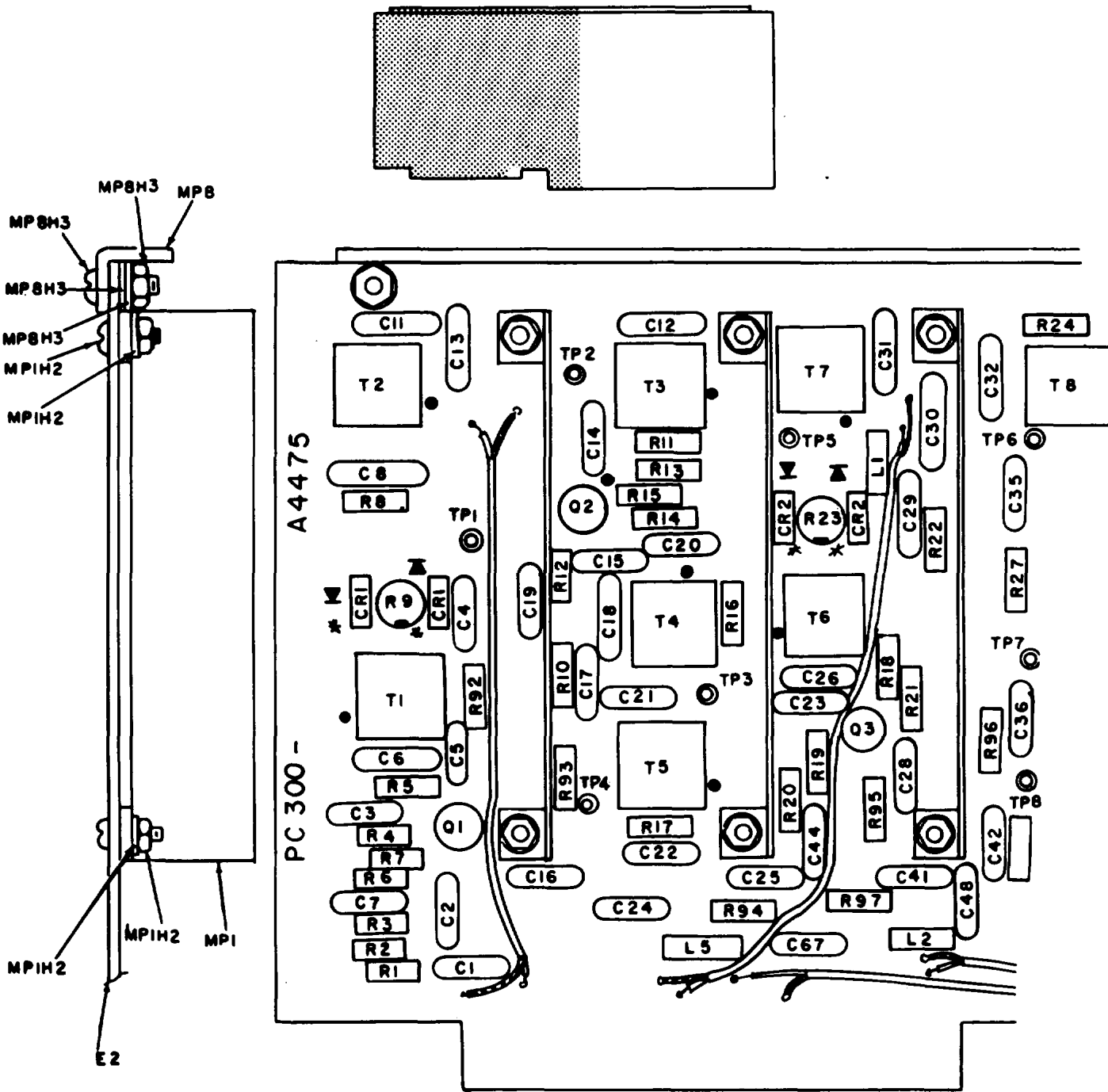

EL-5895-288-24P-TM-17 ①

Figure 17. Mixer Divider Circuit Card Z105 (Sheet 1 of 2).

SECTION II. REPAIR PARTS LIST

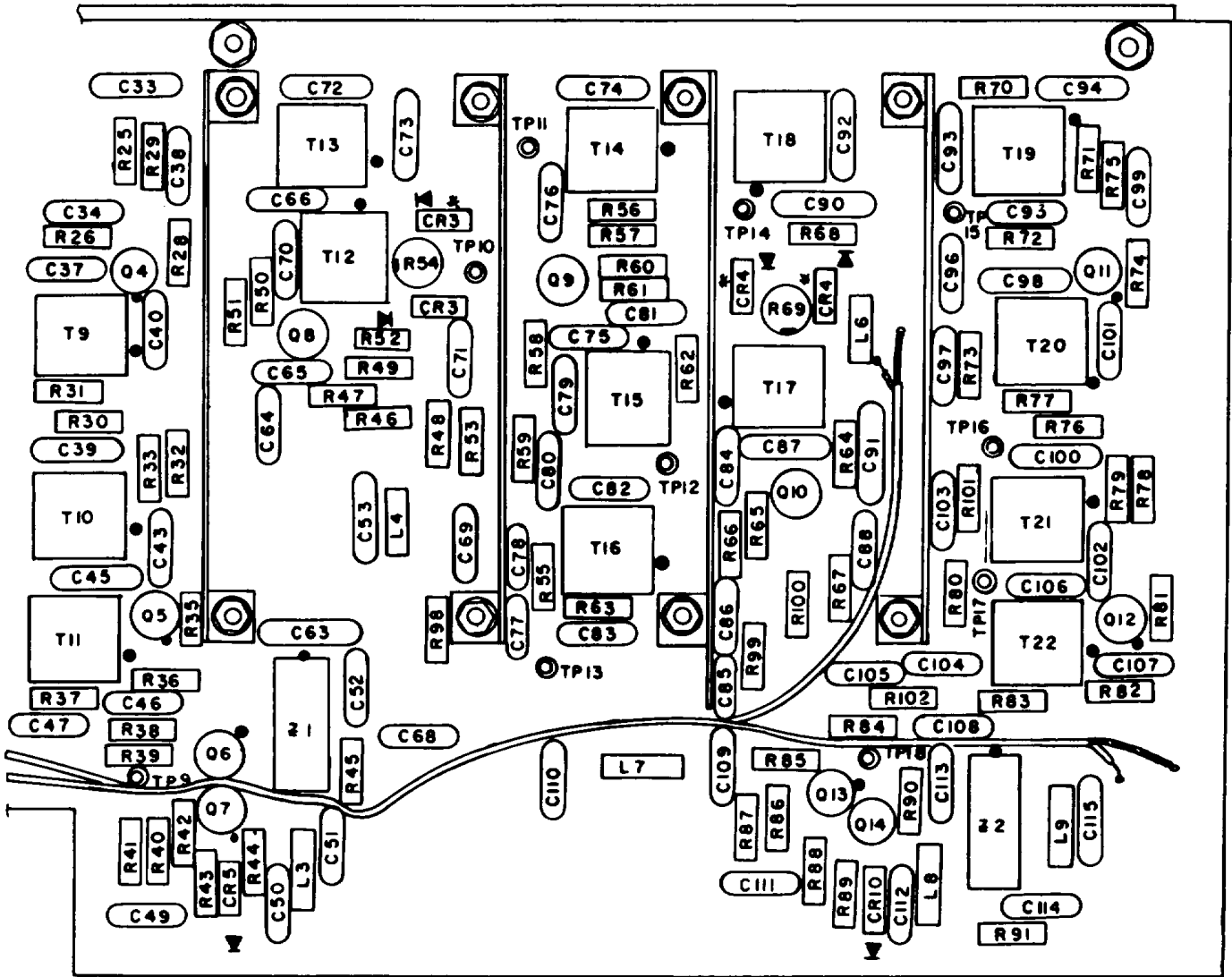
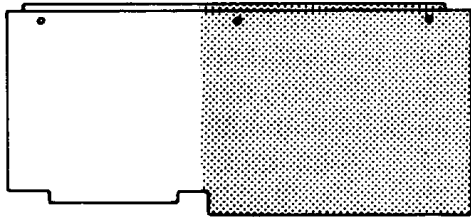

EL-5895-288-24P-TM-17 (2)

Figure 17. Mixer Divider Circuit Card Z105 (Sheet 2 of 2).

SECTION II. REPAIR PARTS LIST

KEY to fig. 17:

Index	Ref Des	Index	Ref Des	Index	Ref Des
1	C1,C2,C3,C4,C5,C7, C14,C15,C16,C17, C20,C22,C23,C24, C25,C28,C34,C35, C36,C38,C41,C42, C43,C44,C46,C47, C48,C49,C64,C65, C66,C67,C68,C69, C71,C75,C76,C77, C78,C81,C83,C84, C85,C86,C88,C95, C96,C97,C99,C102, C103,C104,C105, C107,C108,C109, C110,C111	23 24 25 26 27 28	R8,R46 R22,R68 R37,R83 R38,R39,R84,R85 C8,C63,C53,C115 C50,C51,C52,C112, C113,C114	56 57 58 59 60	MP8 MP8H3 MP8H3 MP8H3 MP8H3
2	C6,C11,C12,C18,C21, C70,C72,C74,C79, C82	29 30 31 32 33 34 35 36 37	R40,R44,R86,R90 R43,R89 R42,R88 R95,R100 R19,R41,R65,R87 R2,R48 R9,R23,R54,R69 T2,T3,T4,T5,T13, T14,T15,T16		
3	R12,R26,R58,R72		T1,T2,T3,T4,T5, T6,T7,T8,T9,T10, T11,T12,T13,T14, T15,T16,T17,T18, T19,T20,T21,T22		
4	C13,C19,C73,C80		Q1,Q2,Q3,Q4,Q5, Q6,Q7,Q8,Q9,Q10, Q11,Q12,Q13,Q14		
5	R14,R61		TP1,TP2,TP3,TP4, TP5,TP6,TP7,TP8, TP9,TP10,TP11, TP12,TP13,TP14, TP15,TP16,TP17, TP18		
6	R7,R15,R28,R35, R52,R60,R78,R81	38	CR1,CR2,CR3,CR4 T6,T17 T7,T9,T18,T20		
7	R6,R16,R21,R53, R62,R67	39	L1,L6 T1,T8,T10,T11,T12, T19,T21,T22		
8	R13,R25,R32,R57, R71,R78		Z1,Z2 L4,L9 L3,L8		
9	R1,R11,R47,R56		CR5,CR10 L2,L5,L7 E2		
10	C26,C87		MP1 MP1H2 MP1H2 MP1H2		
11	R18,R64		W1		
12	C31,C33,C37,C39, C45,C92,C94,C98, C100,C106	40 41 42			
13	C29,C30,C90,C91	43			
14	R29,R36,R75,R82, R96,R97,R101,R102	44			
15	R10,R27,R34,R55, R59,R73,R80,R92, R93,R94,R98,R99	45 46 47			
16	C32,C40,C93,C101	48			
17	R24,R30,R70,R76,	49			
18	R31,R77	50			
19	R33,R79	51			
20	R5,R17,R20,R45, R51,R63,R66,R91	52 53			
21	R4,R50	54			
22	R3,R49	55			

SECTION II. REPAIR PARTS LIST

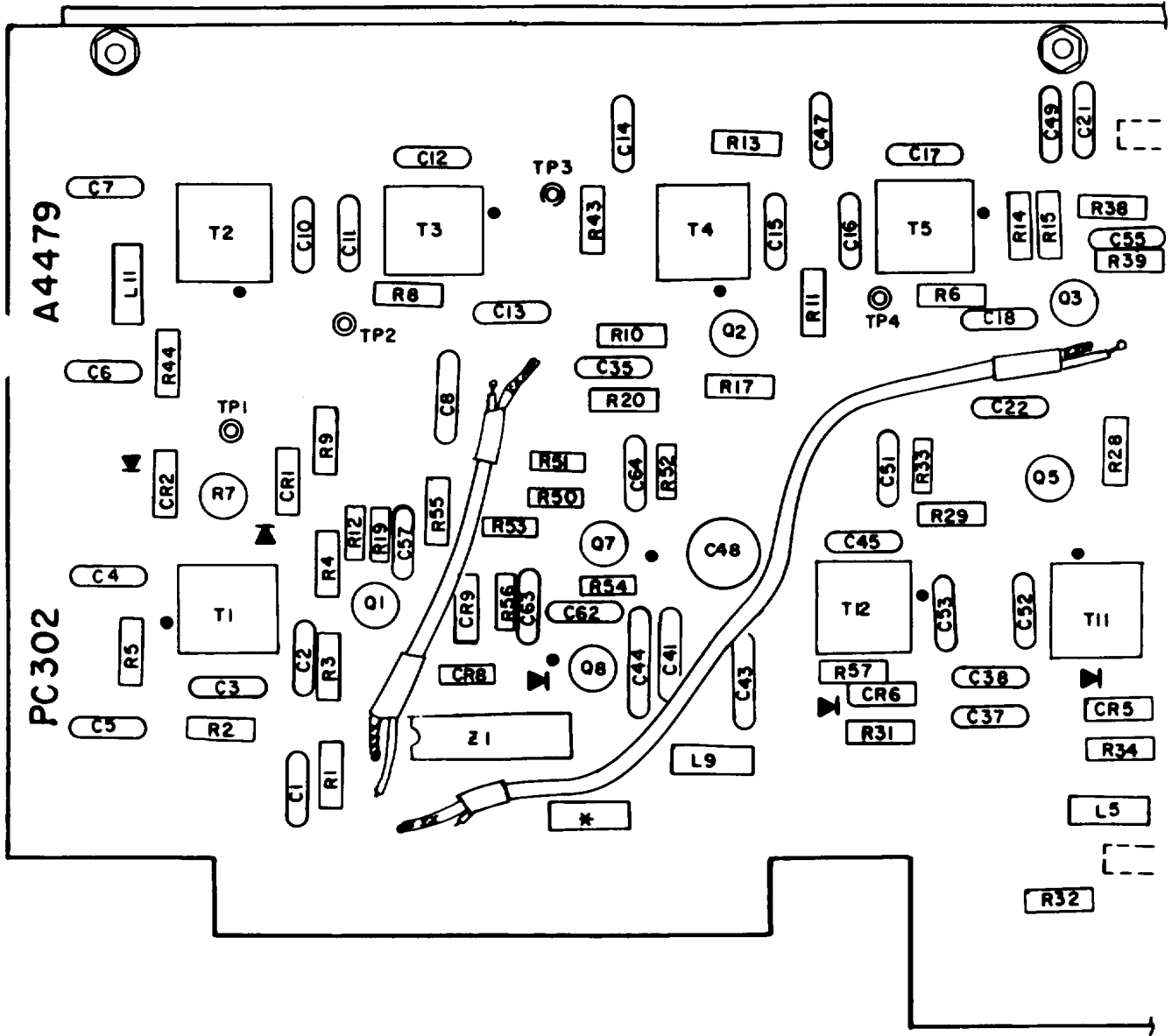
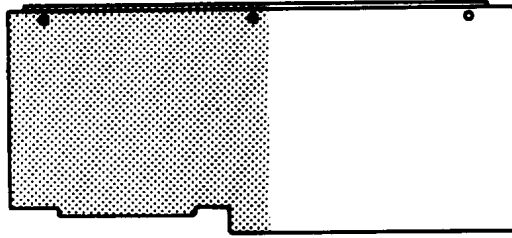

EL-5895-288-24P-TM-18 ①

Figure 18. Mixer Divider Circuit Card Z106 (Sheet 1 of 2)

SECTION II. REPAIR PARTS LIST

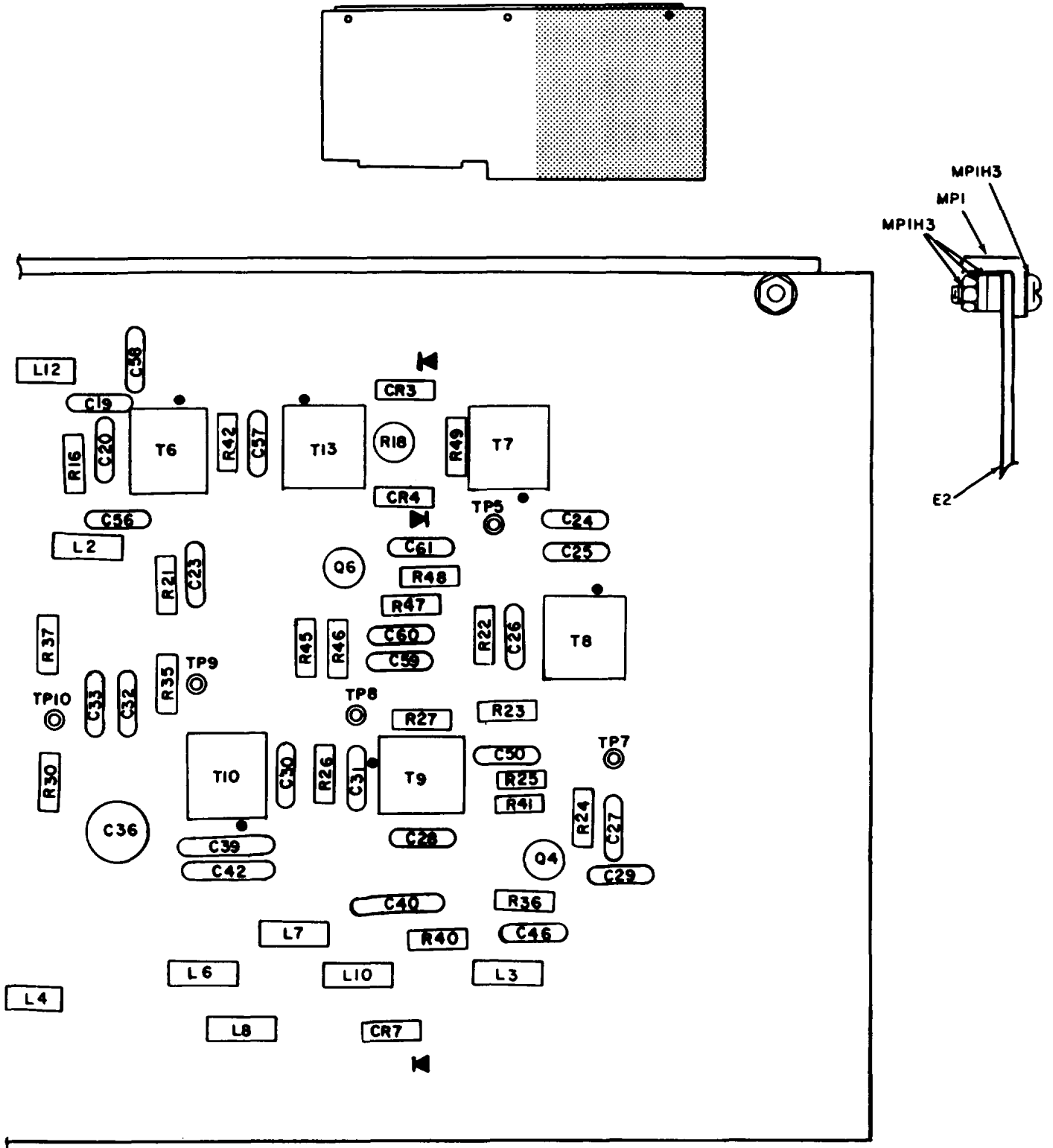

EL5895-288-24P-TM-18 (2)

Figure 18. Mixer Divider Circuit Card Z106 (Sheet 2 of 2)

SECTION II. REPAIR PARTS LIST

KEY to fig. 18

Index	Ref Des	Index	Ref Des	Index	Ref Des
1	C1,C2,C4,C5,C6,C7, C13,C14,C18,C19, C21,C27,C29,C32, C33,C35,C46,C47, C49,C50,C51,C54,C55 C58,C59,C60,C61,C62, C63,C64	36	MP1		
		37	MP1H3		
		38	E2		
		39	R48,R54		
		40	R27,R45		
		41	C24,C26,C28,C30		
		42	R24,R46,R47		
1A	C8	43	C25,C31,C53		
2	C3,C10,C12,C17,C20, C57	44	R23		
		45	R25,R57		
3	R6,R8,R9,R33,R42,R43	46	R41		
4	C11,C16,C56	47	C39,C40,C41,C42,C43, C44		
5	T2,T3,T4,T6				
6	T1,T2,T3,T4,T5,T6, T7,T8,T9,T10,T11, T1250	48	R40		
		49	C36,C48 CR5,CR6,CR7		
7	R20,R55	51	R29		
8	R10	52	R31,R34		
9	TP1,TP2,TP3,TP4,TP5, TP7,TP8,TP9,TP10	53	C45,C52		
		54	C37,C38		
10	R44,R52	55	R32		
11	R17	56	T12		
12	Q1,Q2,Q3,Q4,Q5,Q6, Q7,Q8	57	W1		
		58	R*		
13	R13,R36,R56	59	Z1		
14	C15	60	R50		
15	R11,R15	61	CR8		
16	T5	62	CR9		
17	C22,C23	63	R53		
18	R14,R37	64	R3		
19	R19,R30,R38	65	R2		
20	R12,R39	66	R51		
21	L3,L4,L5,L6,L7,LB, L9,L10,L11,L12	67	R4		
22	R1,R5,R16				
23	R22,R26,R28				
24	L2				
25	T11				
26	R21				
27	T1,T,T100,T13				
2'8	CR1,CR2,CR3,CR4				
2'9	R7,R18				
30	R35				
31	R49				
32	T7,T9				
33	MP1H3				
34	MP1H3				
35	MP1H3				

SECTION II. REPAIR PARTS LIST

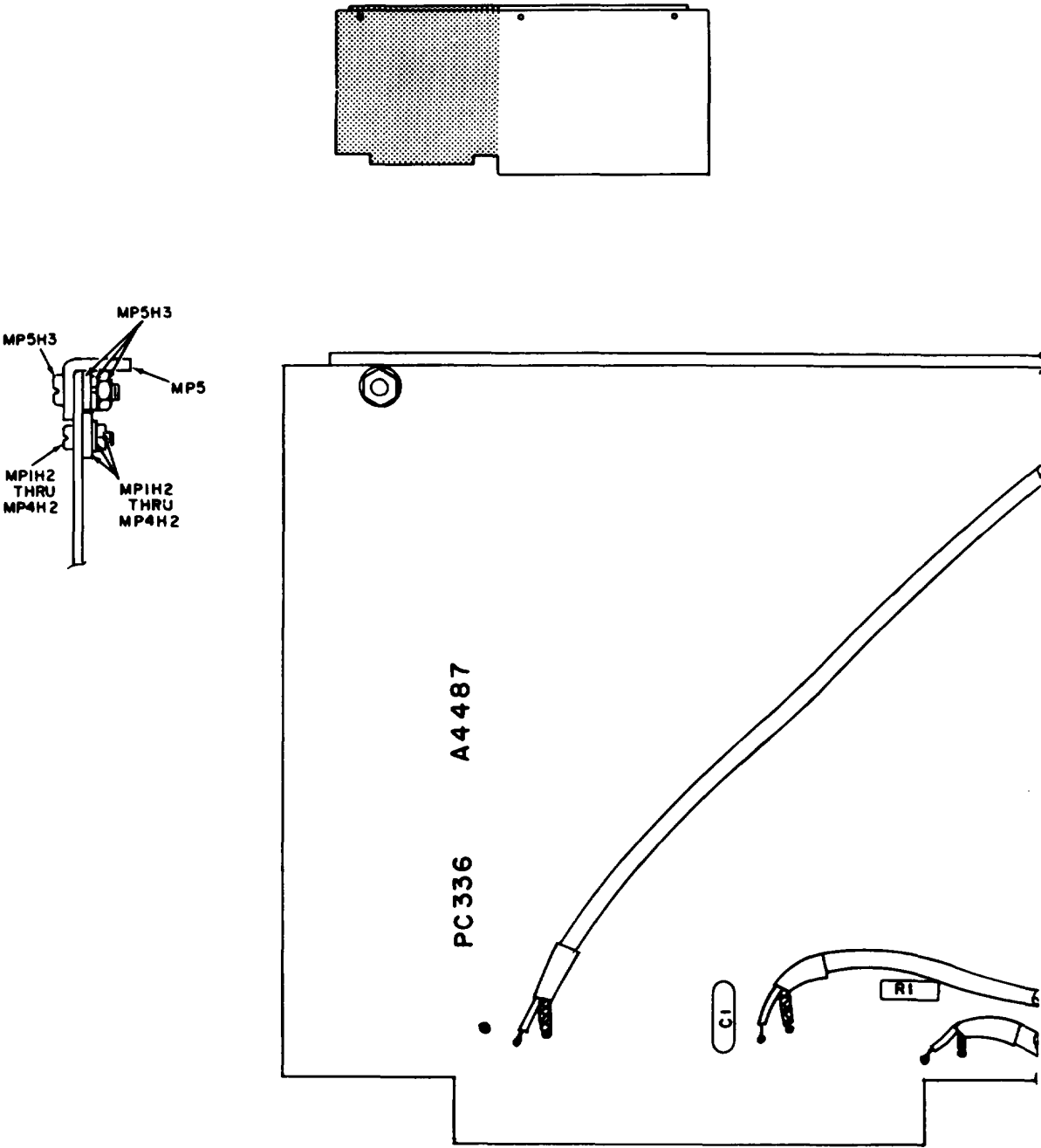

EL 5895-288-24P-TM-19 (1)

Figure 19. Mixer Divider Circuit Card Z104 (Sheet 1 of 2)

SECTION II. REPAIR PARTS LIST

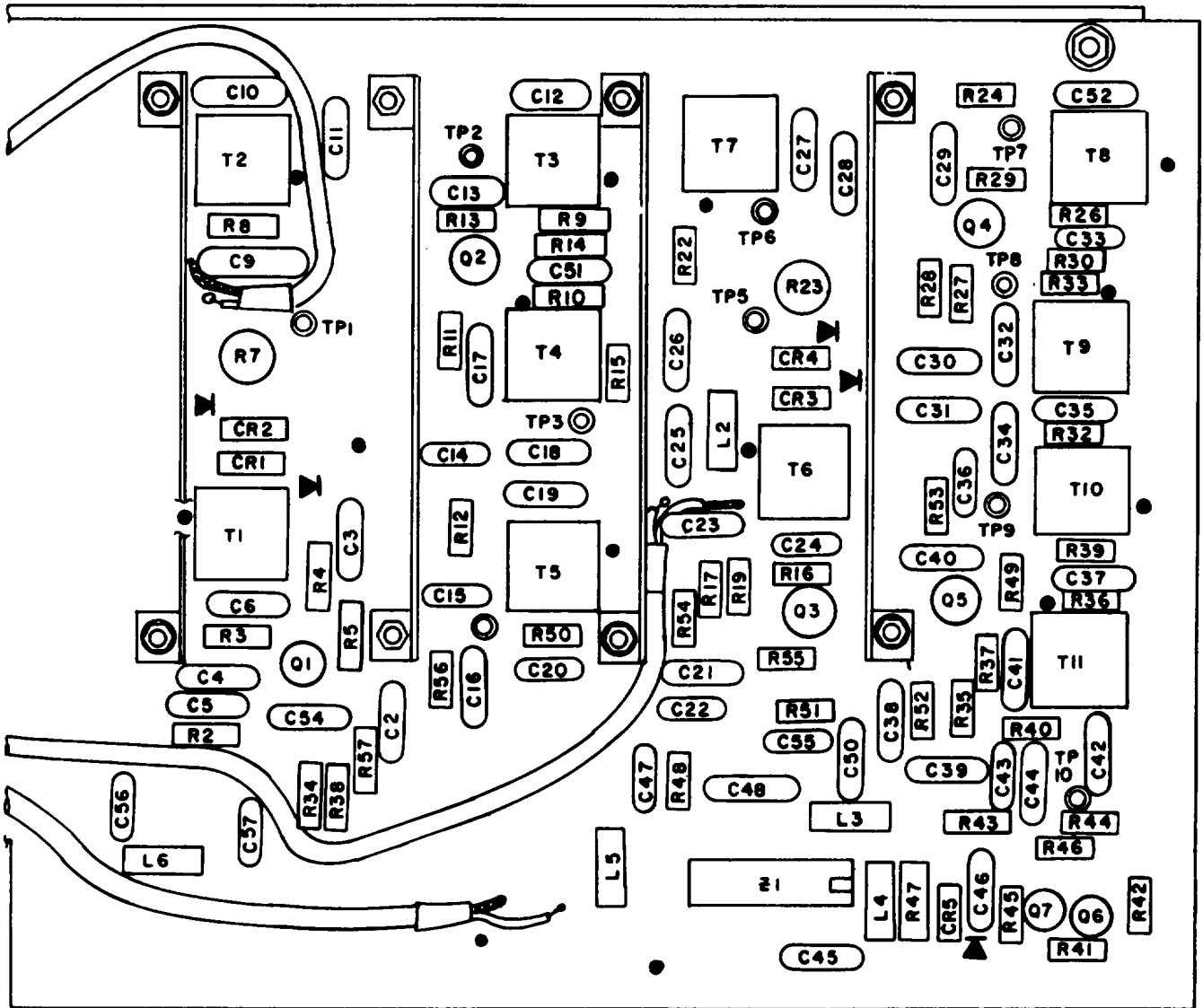
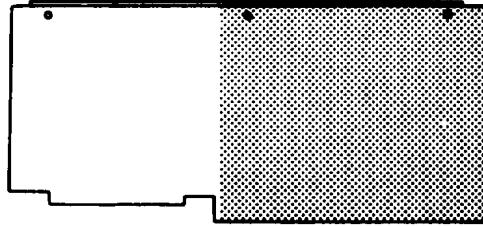

EL 5895-288-24P-TM-19 (2)

Figure 19. Mixer Divider Circuit Card Z104 (Sheet 2 of 2)

SECTION II. REPAIR PARTS LIST

KEY to fig. 19

Index	Ref Des	Index	Ref Des	Index	Ref Des
1	R7,R23	37	R41,R42		
2	TP1,TP2,TP3,TP4,TP5, TP6, TP7,TP8,TP9 TP10	38	R45		
3	C9,C48	39	L3,L6		
4	R8	40	CR5		
5	T2,T3,T4,T5	41	R47		
6	T1,T2,T3,T4,T5,T6, T7,TB,T9,TIO,T11	42	L4		
7	R11,R27,R35	43	C45,C47		
8	C6,C10,C12,C17,C19	44	Z1		
9	C11,C18	45	W1		
10	Q1,Q2,Q3,Q4,Q5,Q6, Q7'	46	L5		
11	R13,R29,R34,R49	47	R2		
12	C1,C2,C3,C4,C5,C13, C14,C15,C16,C20,C21, C22,C23,C29,C30,C31, C33,C36,C37,C38,C39, C40,C42,C43,C44,C46, C50,C51,C54,C55,C56, C57	48	R4		
13	R10,R26,R36	49	R3		
14	R15,R38,R51	50	PC		
15	R14	51	MP1H2 thru MP4H2		
16	RI,R9	52	MP5		
17	C25,C26	53	MP5H3		
18	R22	54	MP5H3		
19	T7,T9	55	MP5H3		
20	L2	56	MP5H3		
21	R5,RI9,R48,R50	57	MP1H2 thru MP4H2		
22	C27,C32,C35,C41, C52	58	MP1H2 thru MP4		
23	CR1,CR2,CR3,CR4	59	MP1 thru MP4		
24	C28,C34				
25	T6				
26	R12,R28,R37,R54, R56,R57				
27	R24,R32				
28	T1,TS,T10,T11				
29	R30,R39,R52,R53				
30	R33				
31	C24				
32	R16				
33	R55				
34	R40				
35	R44,R46				
36	R17,R43				

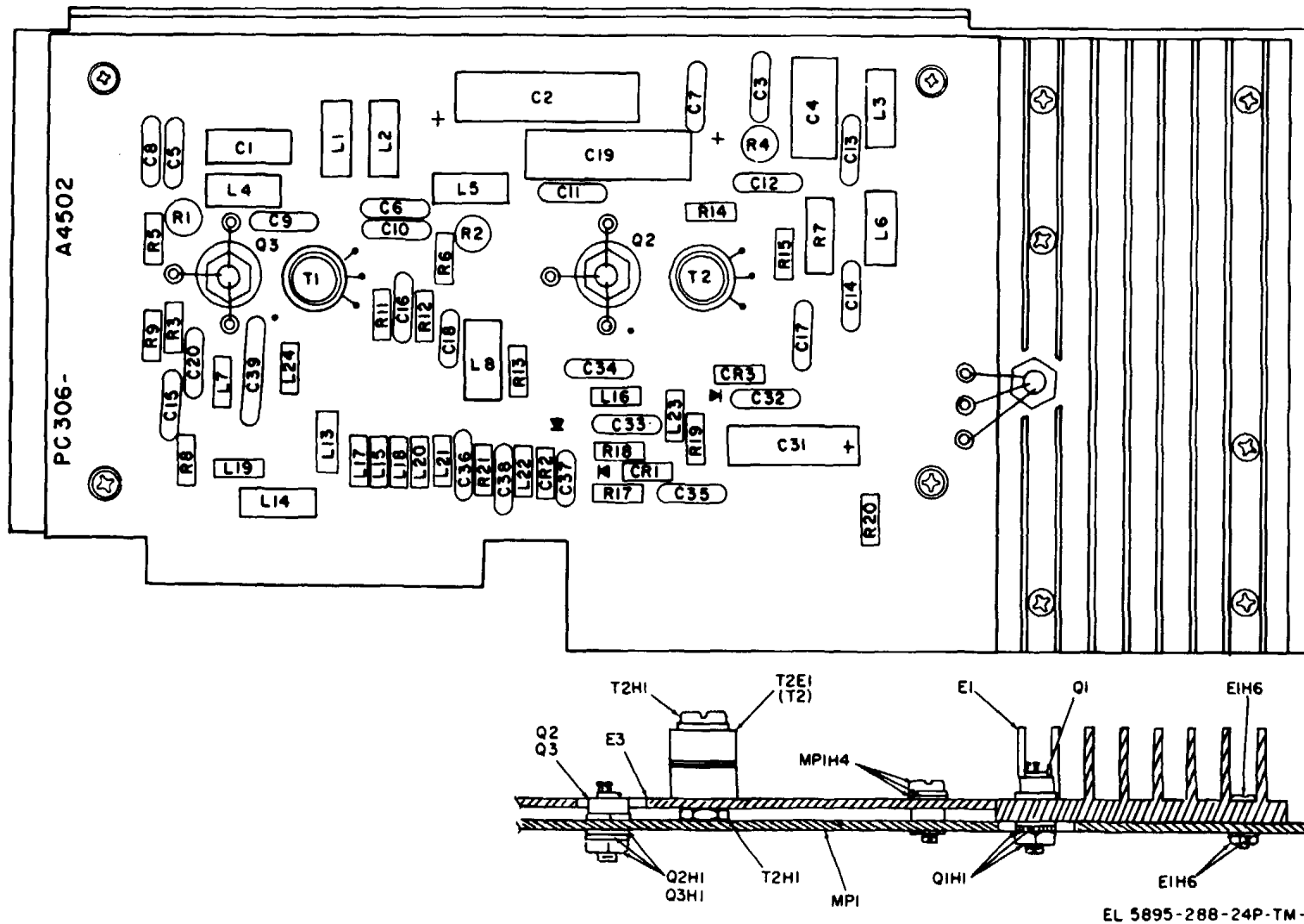
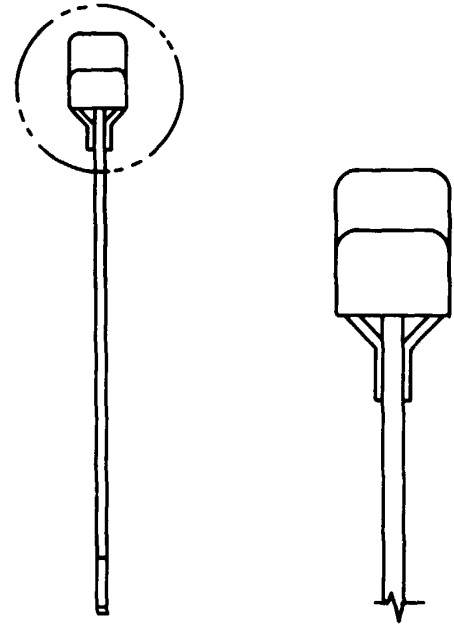
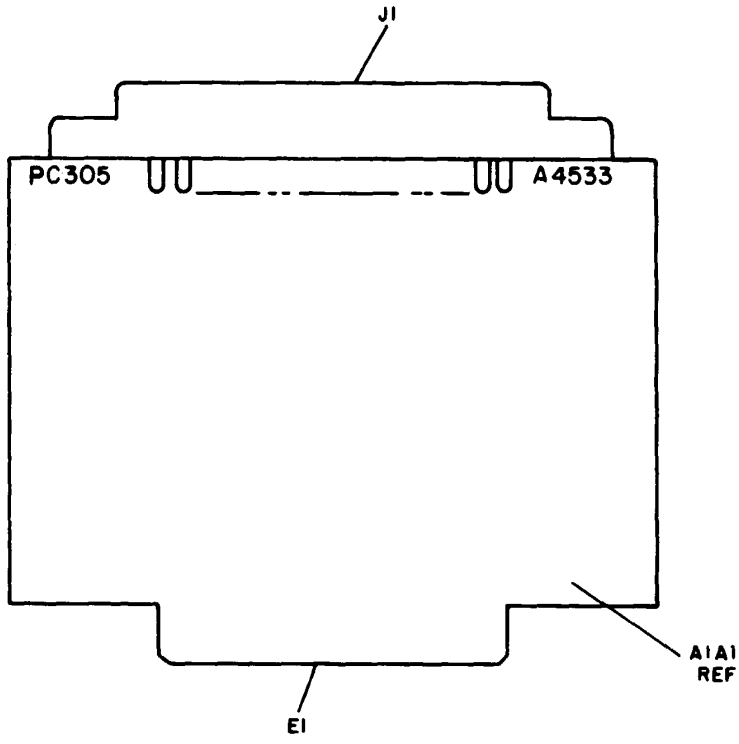

Figure 20. Radio Frequency Output Circuit Card Z115

SECTION II. REPAIR PARTS LIST

KEY to fig. 20

Index	Ref Des	Index	Ref Des	Index	Ref Des
1	C3,C5,C6,C7,C8, C9,C10,C11,C12, C13,C14,C15,C16, C17,C32,C33,C34, C36,C38	42	C39		
2	L1,L2,L3,L4,L5, L6,L8	43	C20		
3	C1,C4	44	T1		
4	R1,R2	45	T1		
5	C2	46	Q3		
6	C19	47	R6		
7	Q2	48	R5		
8	Q2H1	49	Q3H1		
9	Q2H1	50	Q3H1		
10	Q2H1	51	Q3H1		
11	R14,R20	52	MP1H4		
12	R4	53	MP1H4		
13	R7	53A	MP1		
14	Q1	54	MP1H4		
15	Q1H1	55	EI		
16	Q1H1	56	E1H6		
17	Q1H1	57	E1H6		
18	R15	58	E1H6		
19	C31	59	E3		
20	CR2,CR3				
21	T2				
22	T2H1				
23	T2H1				
24	T2H1				
25	T2H1				
26	T2E1				
27	C35,C37				
28	R19				
29	L23				
30	CR1				
31	L13,L15,L16,L17, L18,L19,L20,L21, L22				
32	R18				
33	R7,R9,R12				
34	R21				
35	R13				
36	C18				
37	L14				
38	R3,R8				
39	R11				
40	L24				
41	L7				



EL 5895-288-24P-TM-21

Figure 21. Riser Circuit Card
135

SECTION II. REPAIR PARTS LIST

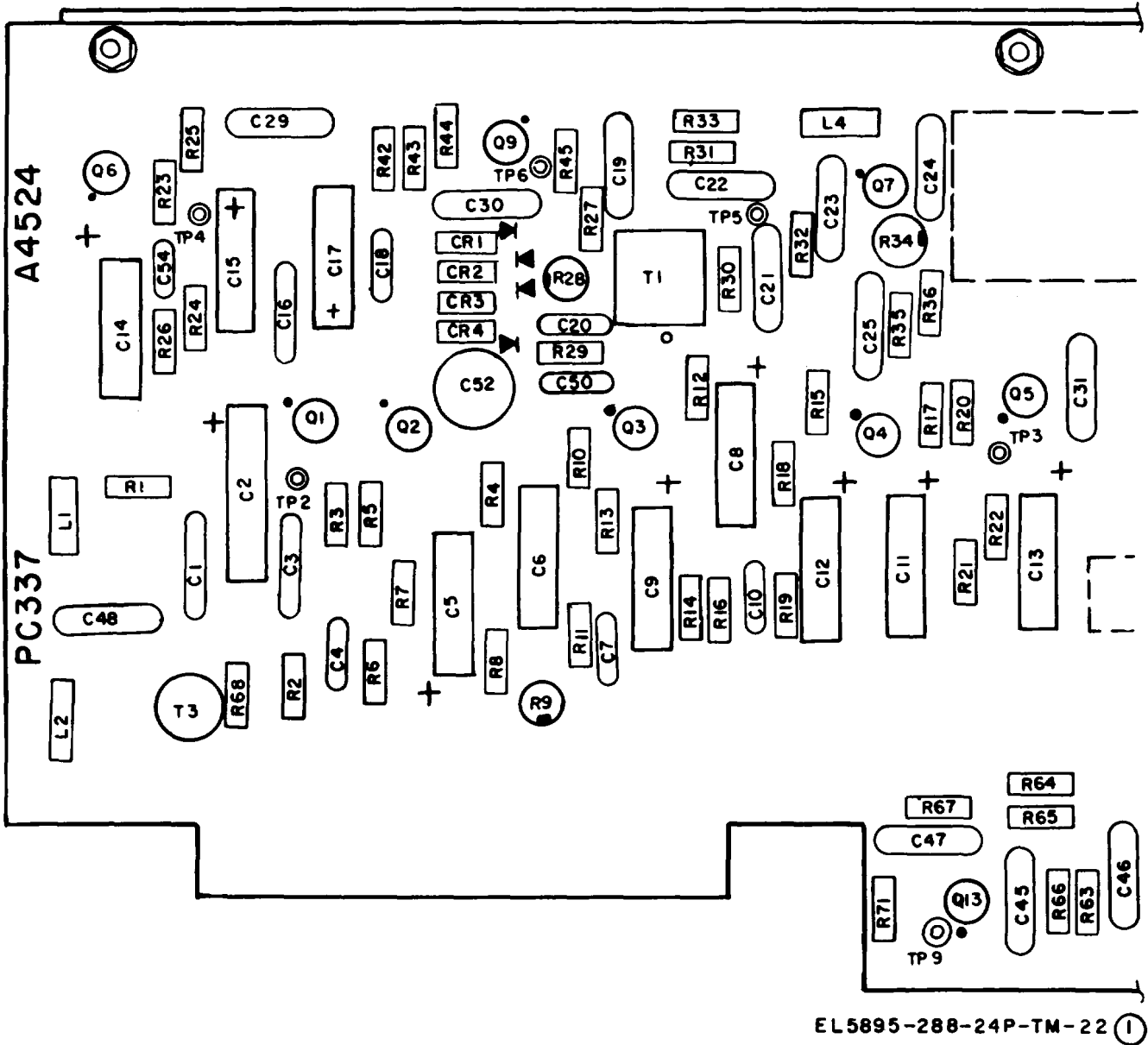
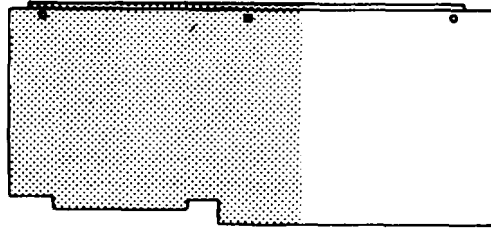
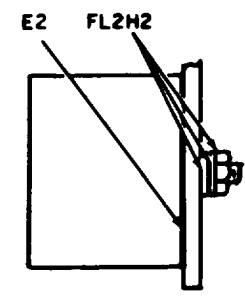
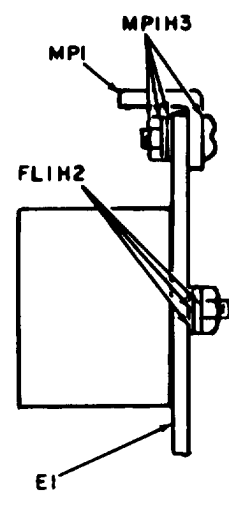
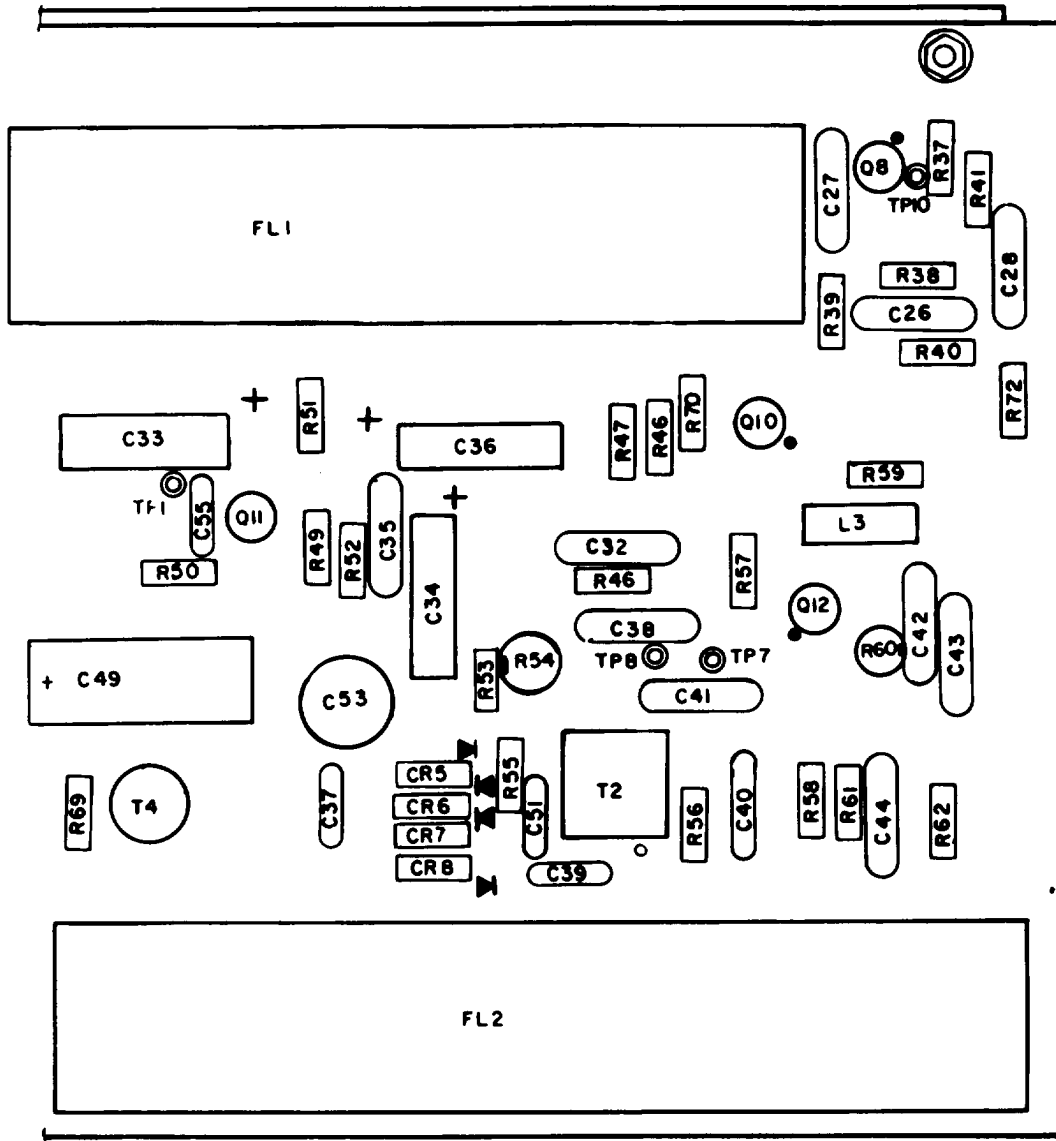
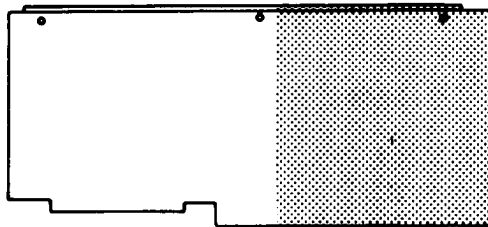

Figure 22. Sideband Generator Circuit Card Z107 (Sheet 1 of 2)

SECTION II. REPAIR PARTS LIST



EL 5895-288-24P-TM-22 (2)

Figure 22. Sideband Generator Circuit Card Z107 (Sheet 2 of 2)

SECTION II. REPAIR PARTS LIST

KEY to fig. 22

Index	Ref	Index	Ref Des	Index	Ref Des
1	R22,R25,R26,R30, R33,R36,R41,R44, R45, R46, R51, R52, R56, R59, R62, R67, R70	27	R13,R18,R71,R72		
2	CR1,CR2,CR3,CR4, CR5,CR6,CR7,CR8	28	FX1		
3	C1,C3,C16,C19,C22, C23,C24,C25,C26, C27,C28,C29,C30, C31,C32,C35,C38, C41,C42,C43,C44, C45,C46,C47,C48	29	FL2H2		
4	R3,R8,R11,R16, R32,R38,R40,R42, R47,R58,R65,R66	30	FL2H2		
5	R43,R46	31	FL2H2		
6	R28,R34,R54,R60	32	E2		
7	Q1,Q2,Q3,Q4,Q5, Q6,Q7,Q8,Q9,Q10, Q11,Q12,Q13	33	PC1		
8	TP1,TP2,TP3,TP4, TP5,TP6,TP7,TP8, TP9, TP10	34	MP1		
9	R14,R19,R27,R9, , R35,R37,R53,R55, R61, R64	35	MP1H3		
10	T1,T2	36	MP1H3		
11	T1,T2	37	MP1H3		
12	R23,R31,R49,R57	38	MP1H3		
13	C21,C40	39	C7,C10,C18,C20, C37,C39		
14	L3,L4	40	C50,C51		
15	R12,R17	41	C52,C53		
16	C8,C11	42	T3,T4		
17	R2,R20	43	C49		
18	C5,C6,C9,C12,C13, C14,C15,C17,C33, C34,C36	44	R10,R15		
19	R21,R24,R50	45	R9		
20	C54,C55	46	R4,R6		
21	FL1	47	R7		
22	FL1H2	48	C4		
23	FL1H2	49	R5		
24	FL1H2	50	L2		
25	E1	51	C2		
26	R39,R63,R68,R69	52	R1		
		53	L1		

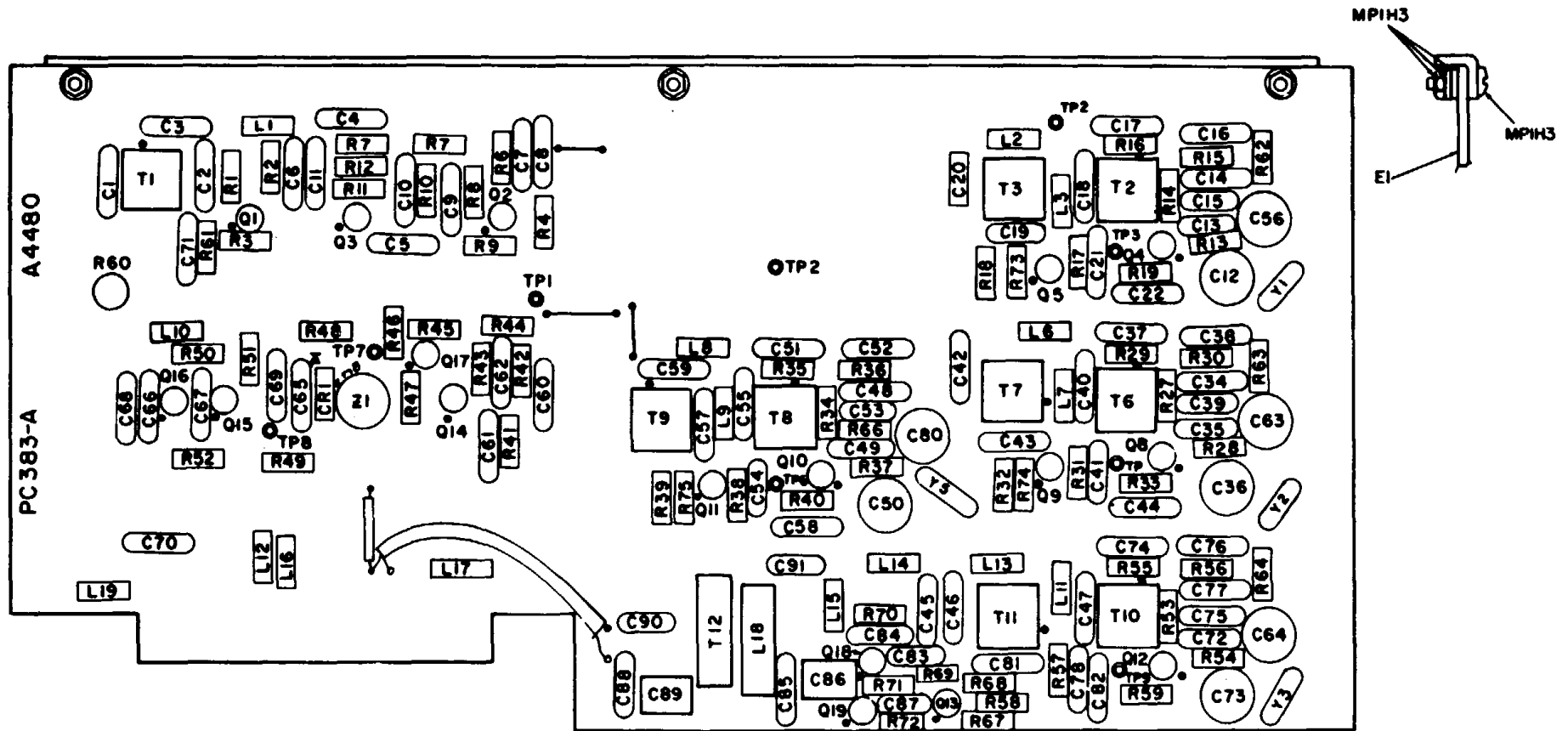

EL 5895-288-24P-TM-23

Figure 23. Spectrum Generator Circuit Card Z101

SECTION II. REPAIR PARTS LIST

KEY to fig. 23

Index	Ref Des	Index	Ref Des	Index	Ref Des
1	C1,C3,C4	26	R6		
2	C6,C7,C8,C100,C11, C14,C16,C17,C18, C20,C22,C34,C37, C38,C40,C42,C44, C45,C46,C47,C48, C51,C52,C55,C58, C59,C60,C61,C62, C65,C70,C71,C74, C76,C77	27	R4,R9,R18,R74,R75		
		28	T3,T7,T9,		
		29	T1,T2,T3,T6,T7,T8, T9,T10,T11		
		30	R19,R33,R40		
		31	T2,T6,T8		
		32	R14,R27,R34,R53		
		33	R62,R63,R64,R66, R68		
3	L1,L2,L3,L6,L7, L8,L9,L100,L11,L12, L13,L14,L16,L17, L19	34	Y50		
		35	R32,R39,R58,R73		
		36	C57,R17,R31,R38		
		37	Y1		
4	C9	38	R13,R28,R37,R54,		
5	TP1,TP2,TP3,TP4, TP5,TP6,TP7,TP8, TP9	39	Y2		
		40	Y3		
		41	T10		
6	C53,C57	42	R59		
7	C13,C21,C35,C41, C49,C54,C72,C78, C82,C83,C84,C87, C90,C91	43	R67		
		44	R71		
		45	R41,R72		
		46	T12		
8	C12,C36,C50,C56, C63,C64,C73,C80	47	T12		
		48	R42,R43		
9	C15,C19	49	W1		
10	C39,C43	50	R45,R47		
11	C75,C81	51	R46		
12	C86,C89	52	CR1		
13	C85	53	R48		
14	L1554		R60		
15	L1855		T1		
15A	L18R1	56	MP1H3		
16	C86	57	MP1H3		
17	C69	58	MP1H3		
18	C66,C67,C68	59	MP1H3		
19	C5	60	MP1H3		
20	R1	61	EI		
21	R2,R15,R30,R36,R56	62	R1		
22	R11,R61	63	Z1		
23	R3,R5,R7,R12,R16, R29,R35,R50,R51,R52, R55				
24	R8,R10,R44,R49,R69, R70				
25	Q1,Q2,Q3,Q4,Q5,Q8,Q9, Q10,Q11,Q12,Q13,Q14, Q15,Q16,Q17,Q18,Q19				

SECTION II. REPAIR PARTS LIST

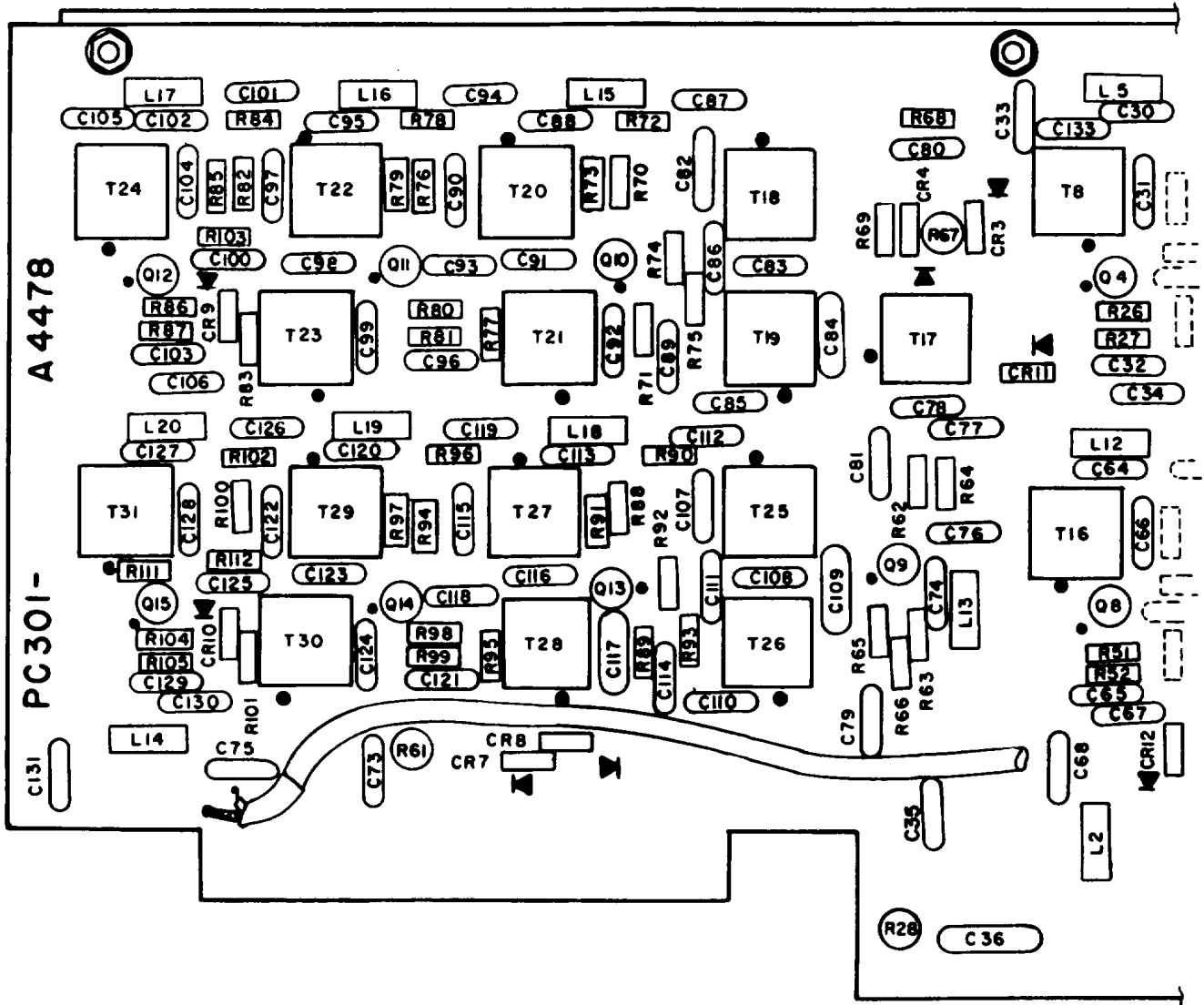
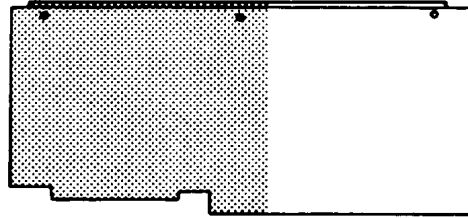

EL 5895-288-24P-TM-24 ①

Figure 24. Step Generator A Circuit Card Z110 (Sheet 1 of 2)

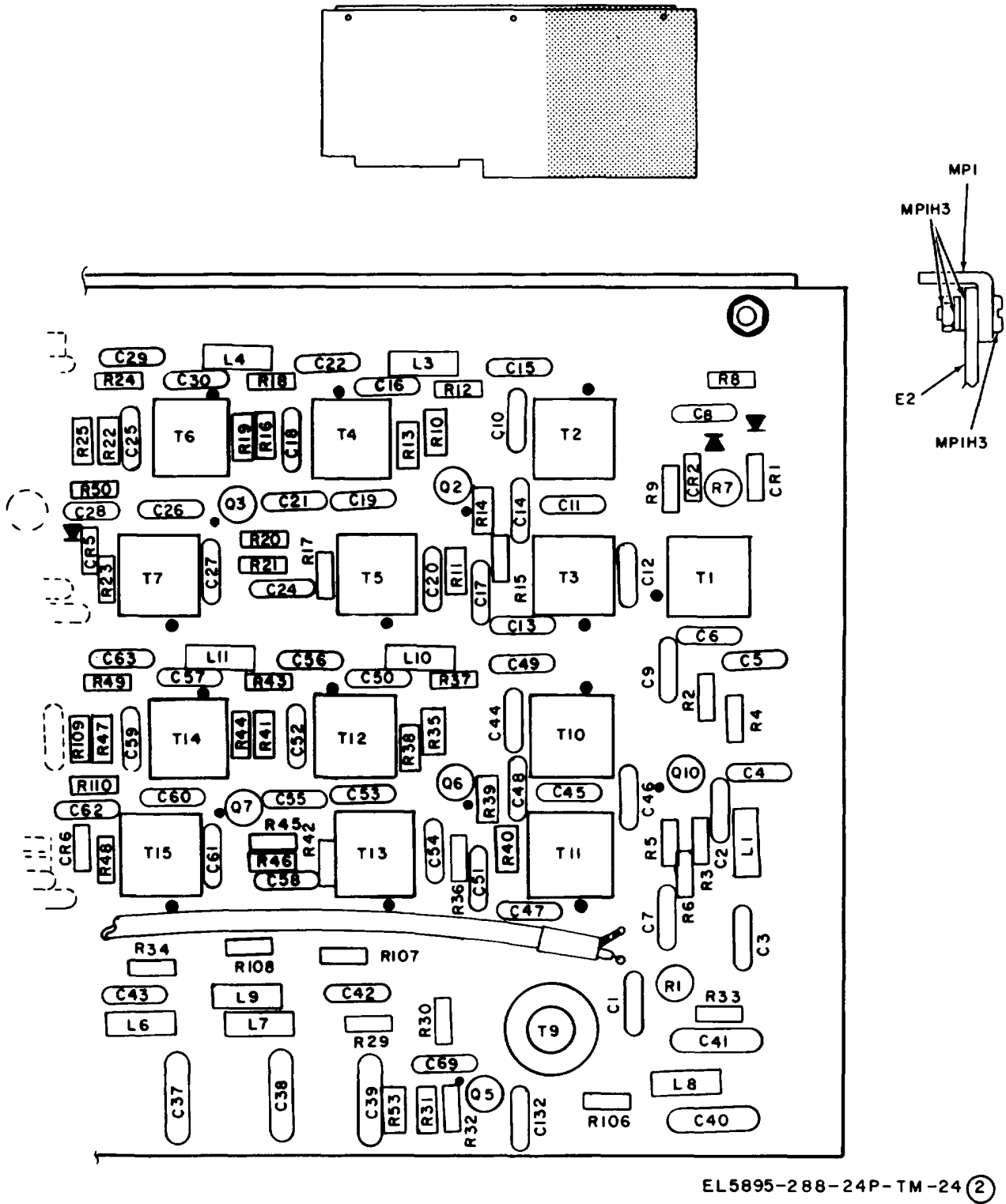

Figure 24. Step Generator A Circuit Card Z110 (Sheet 2 of 2)

SECTION II. REPAIR PARTS LIST

KEY to fig. 24

Index	Ref Des	Index	Ref Des	Index	Ref Des
1	C1,C2,C3,C4,C5,C7, C8,C9,C14,C15,C16, C17,C21,C22,C24, C28,C29,C30,C32, C33,C48,C49,C51, C55,C56,C57,C58,C61, C62,C63,C64,C65,C65, C73,C74,C75,C76,C77, C78,C79,C80,C81,C86, C87,C88,C89,C93,C94 C95,C96,C98,C100, C101,C102,C103,C106, C111,C112,C113,C114, C118,C119,C120,C121, C125,C126,C127,C131, C133	18	R4,R12,R18,R29,R37, 49 R43,R64,R72,R78,R90,50 R96		MP1H3 E2
		19	R21,R33,R34,R46,R81, R99,R106,R107,R108		
		20	T20,T22,T27,T29		
		21	T1,T2,T3,T4,T5,T6, T7,T10,T11,T12,T13, T14,T15,T16,T17,T18, T19,T20,T21,T22,T23, T24,T25,T26,T27,T28, T29,T30,T31		
		22	R20,R45,R80,R98		
		23	R13,R19,R23,R38,R44, R48,R73,R79,R83,R91, R97,R101		
2	Q1,Q2,Q3,Q4,Q5,Q6, Q7QB,Q9,Q Q,Q,Q II,Q12, Q13,Q14,Q15	24	R3,R11,R17,R21,R36, R42,R63,R71,R77,R89, R95		
3	C11,C19,C26,C45,C53, C60,C83,C91,C98,C108, C116,C123	25	T19,T21,T23,T26,T28, T30		
		26	R14,R39,R74,R93		
4	C6,C82,C84,C90,C92, C97,C99,C107,C109, C115,C117,C122,C124, C13,C34,C47,C67,C85, C106,C110,C130	27	T18,T25		
		28	R15,R27,R40,R52,R75, R87,R93,R105		
5	CR1,CR2,CR3,CR4	29	T1,T17		
6	CR5,CR6,CR7,CR8,CR9, CR10,CR11,CP12	30	R7,R67		
7	C31,C66	31	R8,R9,R25,R50,R68, R69,R85,R103,R109, R110,R111,RI12		
8	C10,C12,C18,C20,C25, C27,C44,C46,C52,C54, C59,C61,C68	32	T8,T16,T24,T31		
9	C40,C41,C42,C43	33	R51,R97,R101,R104		
		34	R22,R47,R82,R100		
10	C132	35	T4,T6,T12,T14		
		36	T3,T5,T7,T11,T13, T15		
11	C35,C36,C37,C38,C39, C69	37	R5,R65		
12	W1	38	R6,R32,R66		
13	C104,C128	39	R1,R28,R61		
14	L1,L2,L3,L4,L5,L10, L11,L12,L13,L14 L15,L16,L17,L18,L19, L20	40	T9		
15	R24,R49,R84,R102	41	T9		
		42	L8,L9		
16	R2,R10,R16,R30,R35, R41,R62,R70,R76,R88, R94	43	R53		
		44	L6,L7		
		45	MP1		
		46	MP1H3		
		47	MP1H3		
		48	MP1H3		

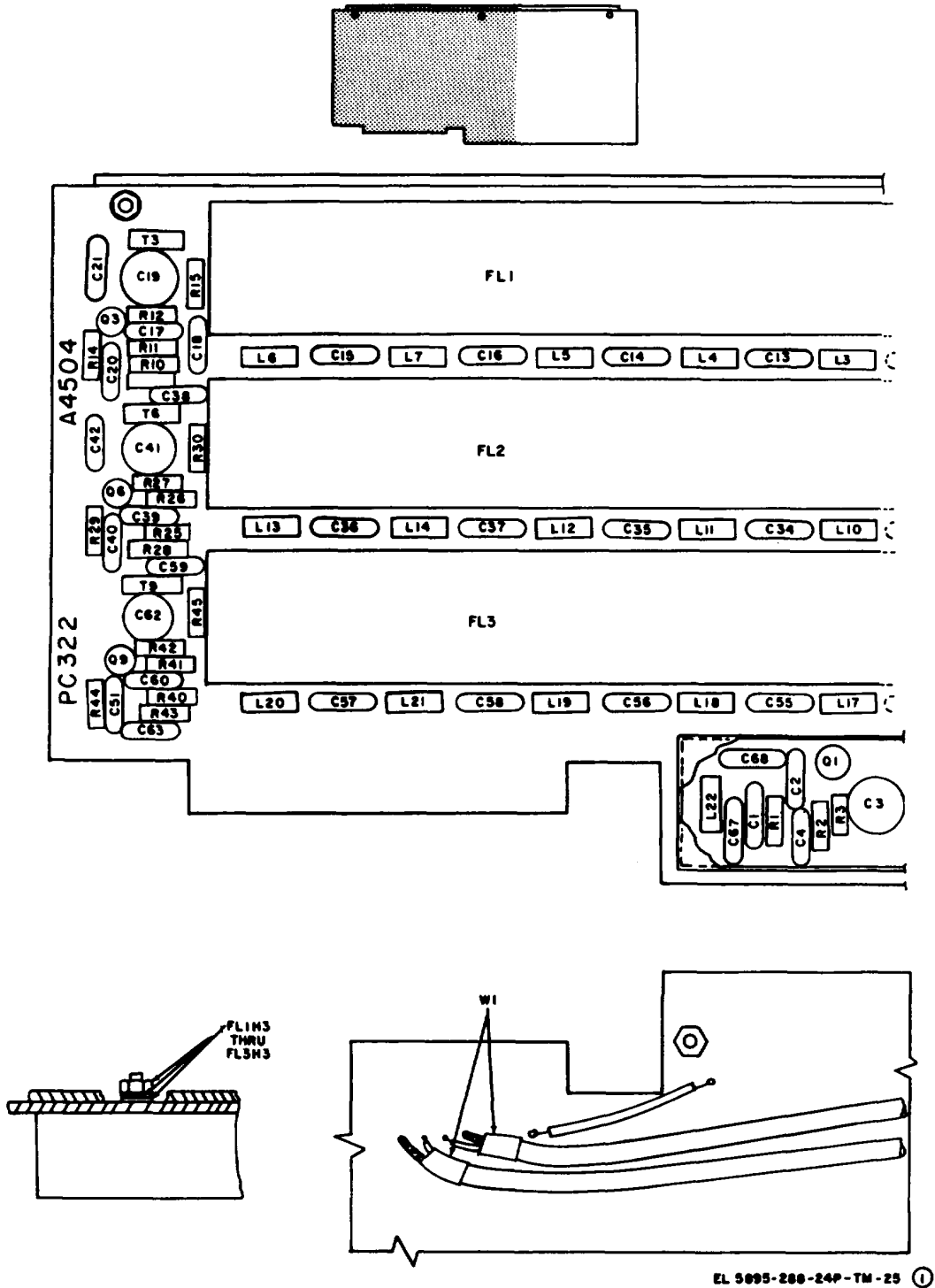
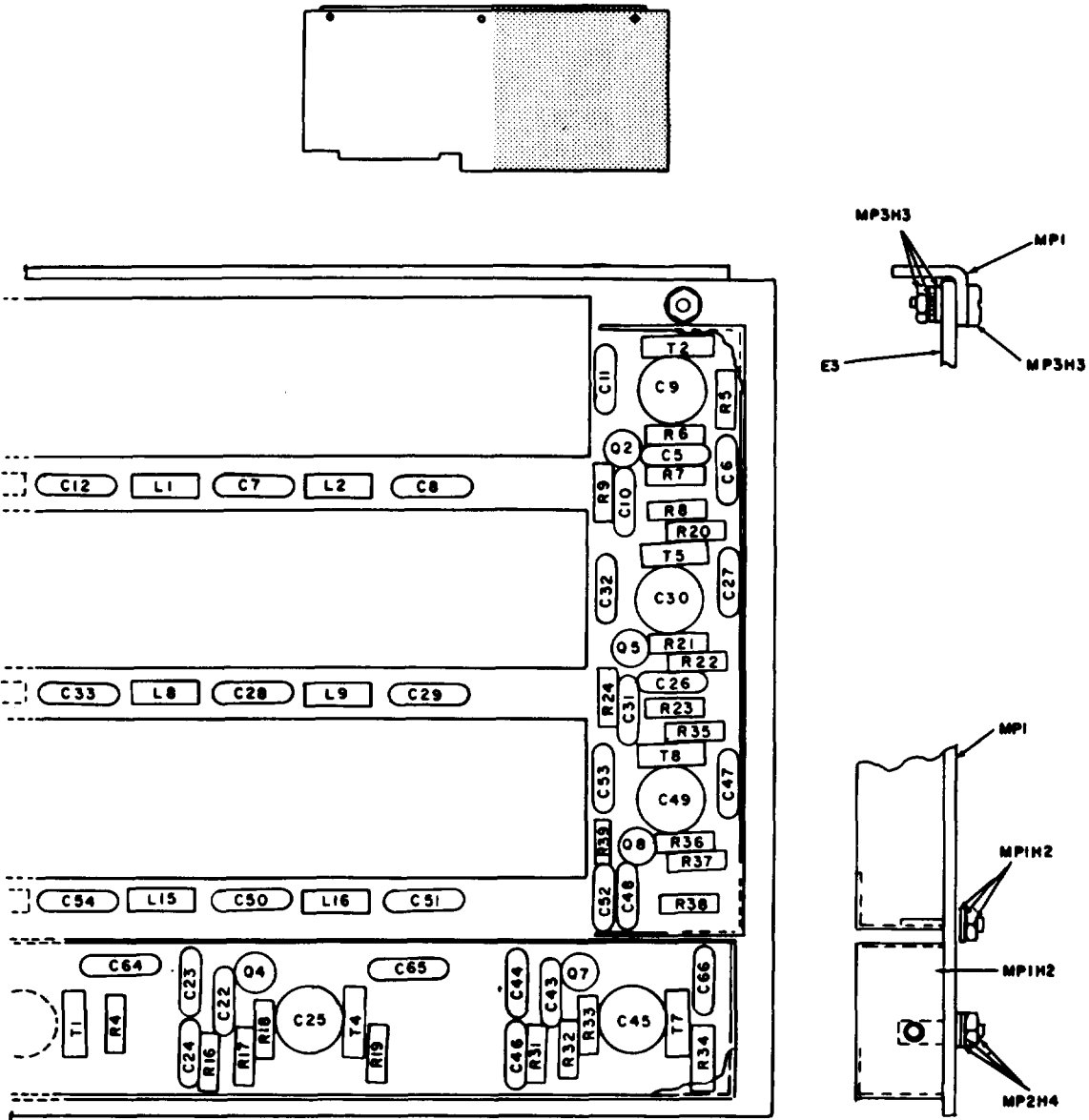

Figure 25. Step Generator B Circuit Card Z11 (Sheet 1 of 2)

Section II. REPAIR PARTS LIST



EL 5895-24P-TM-25 (2)

Figure 25. Step Generator B Circuit Card Z111 (Sheet 2 of 2)

Section II. REPAIR PARTS LIST

KEY to fig. 25

Index	Ref Des	Index	Ref Des	Index	Ref Des
1	C11, C15, C21, C32, C36, C42, C53, C57, C63, C64, C65, C66	28	W1		
2	R1, R10, R16, R25, R31, R40,	29	MP1		
3	C2, C4, C5, C6, C7, C8, C10, C12, C14, C16, C17, C18, C20, C22, C23, C24, C26, C27, C28, C31, C33, C35, C37, C38, C39, C40, C43, C44, C46, C47, C48, C50, C51, C52, C54, C56, C58, C59, C60, C61	30	MP1H2		
4	T1, T2, T3, T4, T5, T6, T7, T8, T9	31	MP1H2		
5	T1R1, T2R1, T3R1, T4R1, T5R1, T6R1, T7R1, T8R1, T9R1,	32	MP1H2		
6	C3, C9, C19, C25, C30, C41	33	MP1H2		
7	R12, R27, R42	34	MP2H4		
8	R5, R15, R20, R30, R35, R45	35	MP2H4		
9	R7, R11, R22, R26, R37, R41	36	MP2H4		
10	L6, L13, L20	38	FL1H3 thru FL3H3		
11	L1, L2, L3, L5, L7, L8, L9, L10, L12, L14, L15, L16, L17, L19, L21	39	FL1H3 thru FL3H3		
12	FL3	40	E3		
13	L4, L11, L18	41	MP1		
14	FL1	42	MP3H3		
15	C13, C34, C55	43	MP3H3		
16	FL2	44	MP3H3		
17	R9, R14, R24, R29, R39, R44				
18	Q1, Q2, Q3, Q4, Q5, Q6, Q7, Q8, Q9				
19	R6, R21, R36				
20	R8, R13, R23, R28, R38, R43				
21	C45, C49, C62				
22	R4, R19, R34				
23	R3, R18, R33				
24	R2, R17, R32				
25	C1, C68				
26	C67				
27	L22				

Section II. REPAIR PARTS LIST

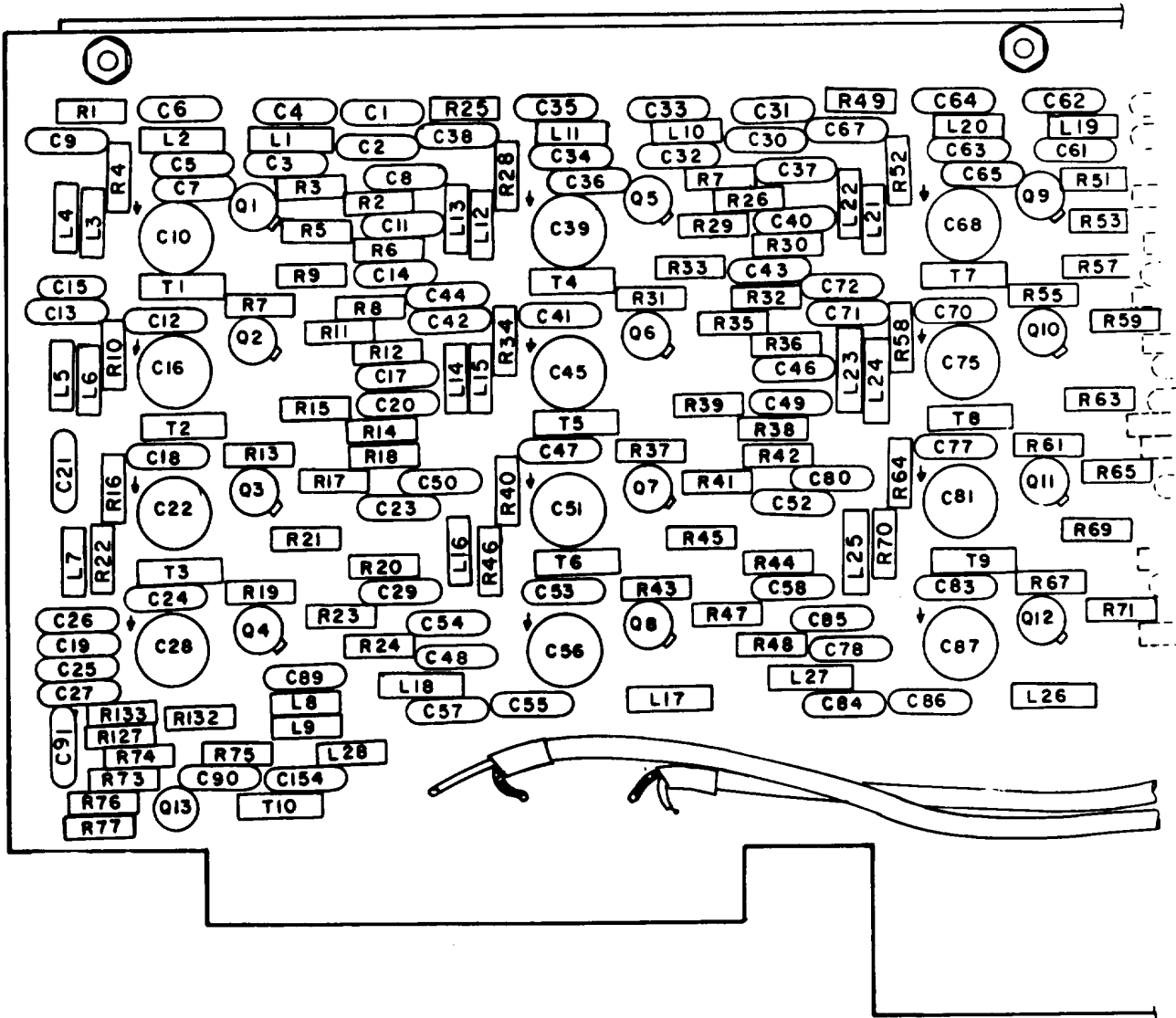
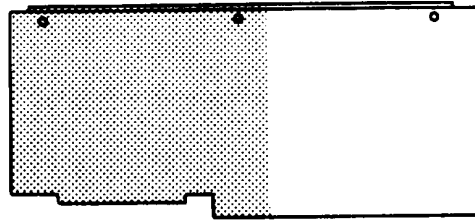

EL 5895-288-24P-TM-26 ①

Figure 26. Step Generator C Circuit Board Z113 (Sheet 1 of 2)

Section II. REPAIR PARTS LIST

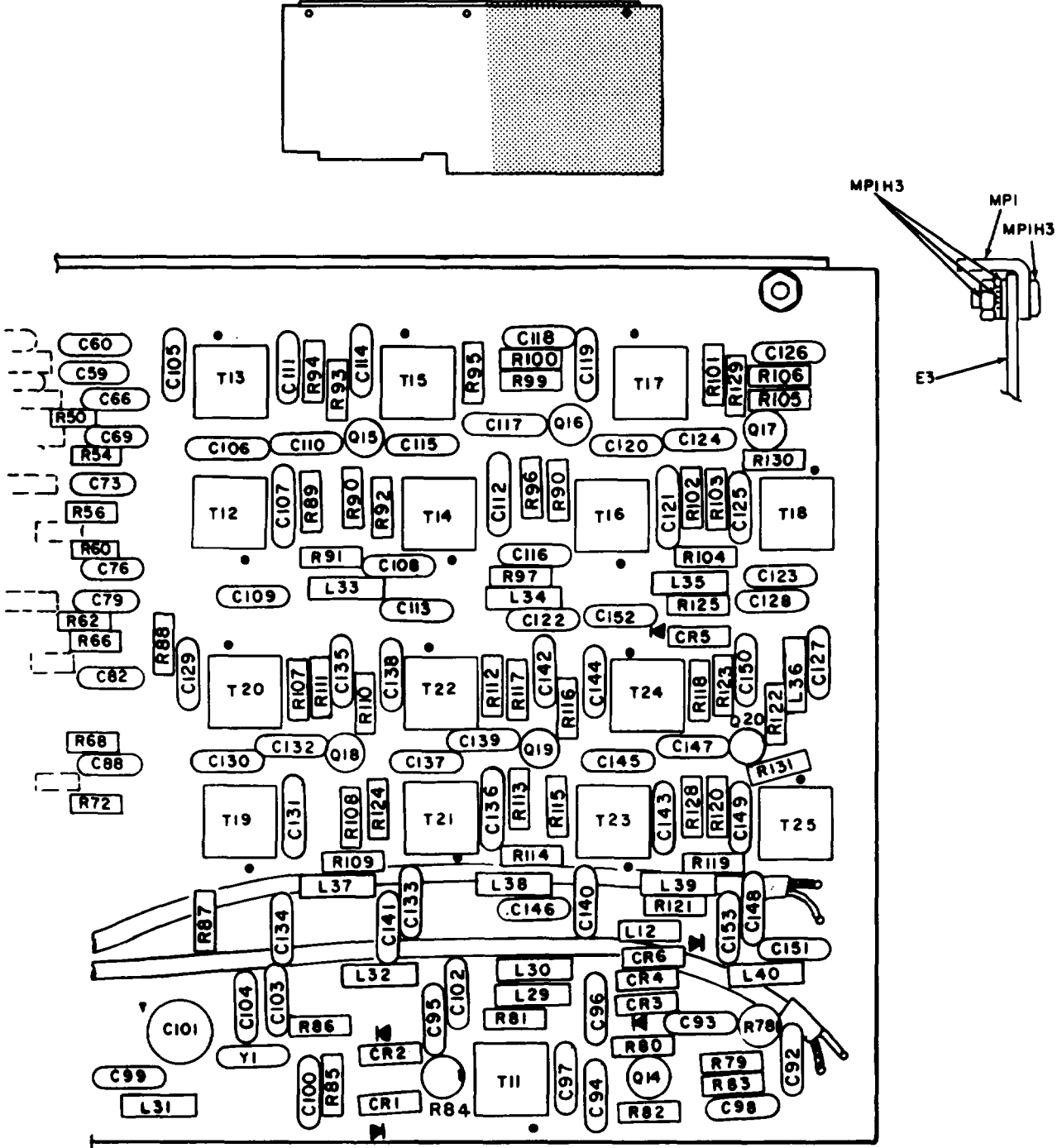

EL 5895-288-24P-TM-26 (2)

Figure 26. Step Generator C Circuit Board Z113 (Sheet 2 of 2)

Section II REPAIR PARTS LIST

KEY to figure 26

Index	Ref Des	Index	Ref Des	Index	Ref Des
1	C5, C35, C63	25	C28, C56, C87	52	R24, R48, R72, R94, R106, R111, R123
2	Q1 thru Q13	26	E3	53	R93, RI10
3	C6, C105, C107, C112, C114, C119, C121, C129, C131, C136, C138, C143, C144	27	MP1	54	R81, R91, R97, R104, R109, RI14, R121
4	C6	29	MP1H3	55	R92, R98, R103, R115, R120, R124
5	C7, C8, C9, C11, C13, C14, C15, C17, C18, C19, C20, C21, C23, C24, C25, C26, C29, C36, C37, C38, C40, C42, C43, C44, C46, C47, C48, C49, C50, C52, C53, C54, C57, C58, C65, C66, C67, C69, C71, C72, C73, C76, C77, C78, C79, C80, C82, C83, C84, C85, C88, C89, C90, C91	30	MP1H3	56	L29, L30, L32, L33, L34, L35, L36, L37, L38, L39, L40
6	C4	31	MP1H3	57	R85, R100, R117
3	C2	32	R1, R25, R49	58	R99, RI16
9	C1	33	R3, R9, R15, R21, R27, R33, R39, R45, R51, R57, R63, R69, R80, R90, R96, R108, R113	59	T14, T16, T21, T23
10	C12, C41, C70, C125, C149	34	R2, R8, R14, R26, R32, R38, R50, R56, R62, R68, R79, R89, R95, R107, R112	60	R101, R102, R118, R119
11	C10, C16, C22, C39, C45, C51, C68, C75, C81	35	L2, L9, L10	61	R105, R122
12	C35, C64	36	L1R1, L2R1, L10R1, L11R1, L19R1, L20R1	62	R125, R126
13	C27, C32, C55, C61, C86	37	R5, R23, R29, R47, R58, R71, R86	63	T18, T25
14	C33, C62	38	R6, R12, R18, R30, R36, R42, R54, R60, R66	64	R78
15	C31, C60	39	L1	65	T11
16	C30, C59, C92, C93, C94, C95, C96, C98, C102, C103, C104, C108, C109, C110, C111, C113, C116, C117, C118, C122, C123, C124, C126, C127, C128, C132, C133, C134, C135, C139, C140, C141, C142, C146, C147, C148, C150, C151, C152, C153	40	R10, R16, R22, R34, R40, R46, R58, R64, R70, R75, R77	66	R84
17	C106, C115, C120, C130, C137, C145, C154	41	L3, L4, L5, L6, L7, L9, L12, L13, L14, L15, L16, L18, L21, L22, L23, L24, L25, L27, L28	67	Y1
18	Q14 thru Q20	42	R4, R28, R52	68	L31
19	CR5, CR6	43	R7, R31, R55, R83	69	L26
20	CR3, CR4	44	L11, L20	70	L8R1, L17R1, L26R1
21	C97	45	R11, R13, R17, R19, R35, R37, R43, R59, R61, R65, R67, R82, R123, R127, R132, R133	71	R20, R44
22	CR1, CR2	46	T7, T8, T9	72	L17
23	C99, C100	47	TR1 thru T9R1	73	T4, T5, T6
24	C101	48	R87, R88, R128, R129, R130, R131	74	T10
	W1	49	T13, T15, T17, T20, T22, T24	75	T10R1
		50	T11, T12, T13, T14, T15, T16, T17, T18, T19, T20, T21, T23, T24, T25	76	L8
		51	T12, T19	77	R76
				78	R73
				79	R74
				80	T1, T2, T3

Section II. REPAIR PARTS LIST

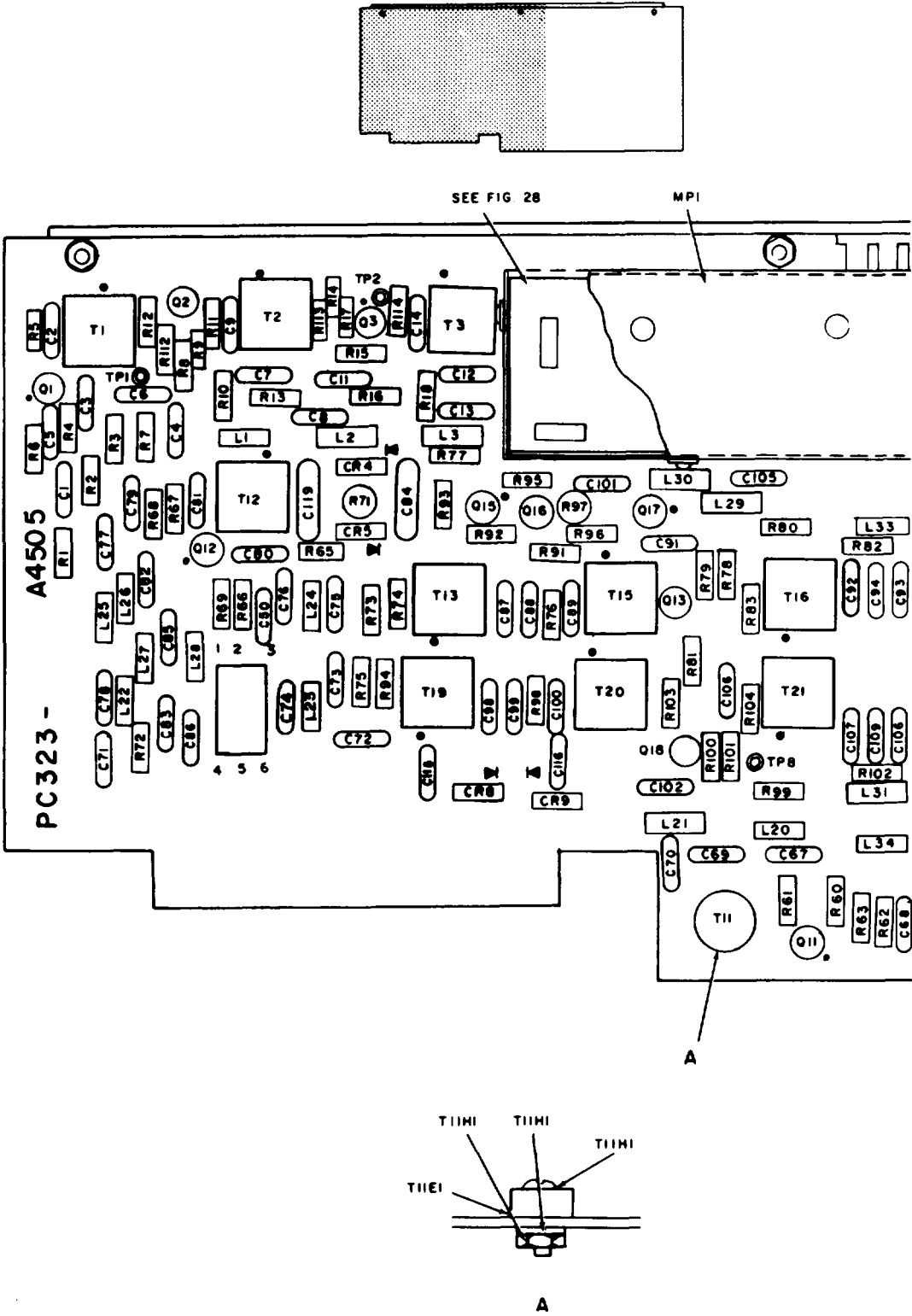

EL-5895-288-24P-TM-27 (1)

Figure 27. Translater Circuit Card Z112 (Sheet 1 of 2)

Section II. REPAIR PARTS LIST

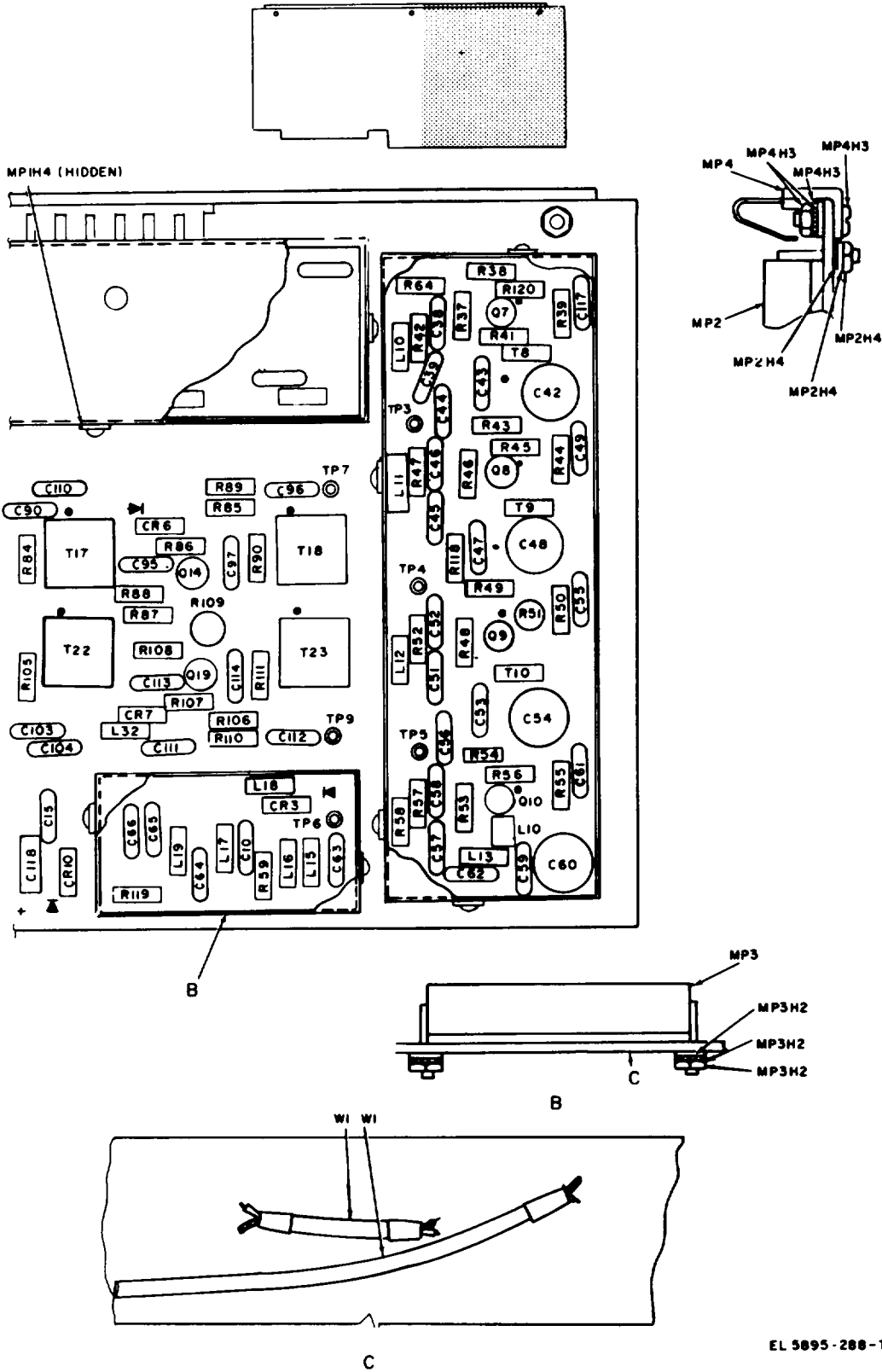

Figure 27. Translator Circuit Card z112 (Sheet 2 of 2)

SECTION II. REPAIR PARTS LIST

KEY to fig. 27

Index	Ref Des	Index	Ref Des	Index	Ref Des
1	C2, C9, C14	28	L1, L2, L3, L27, L28	73	C43, C47, C53
2	TP1 thru TP9	29	T13, T15, T16, T17,	74	C42, C48, C54
3	Q1, Q2, Q3, Q12, Q13, Q14, Q15, Q16, Q17, Q18, Q19		T18, T19, T20, T21, T22, T23	75	R47
4	C1, C3, C5, C6, C7, C11, C12, C13, C50, C78, C79, C80, C82, C90, C91, C95, C96, C101, C102, C103, C104, C105, C106, C110, C111, C112, C113, C115, C116, C87, C89, C92, C93, C97, C98, C100, C107, C108, C114	30	R93	76	R46
		31	R57, R72, R114	77	C39, C45, C51, C57
		32	R92	78	C60
		33	R86, R95, R107	79	L10
		34	R91	80	80
		35	R96	81	C10, C63
		36	R53, R97	82	CR3
		37	L15, L29, L30	83	L17
5		38	R79, R100	84	C64
		39	R78, R101	85	
		40	R74, R83, R94, R104	86	C65
6	C88, C94, C99, C109	41	L20, L21, L22, L25, L26, L31, L32, L33, L34	87	C85
7	C15, C67			88	C59
8	C118	42	R76, R84, R98, R105	89	R48
9	C68	53	CR6, CR7, CR10	90	MP1
10	C66, C69, C84	44	R89, R106	91	MP1H4
11	C70, C73	45	R85, R106	92	MP1H4
12	C72	46	R90, R111	93	MP(1H4
12A	C74	47	R109	94	MP2
13	C4, C8, C71, C77	48	R44, R50, R55, R62	95	MP2H4
14	C83, C86	49	R63	96	MP2H4
15	C75, C76	50	R60	97	MP2H4
16	C81	51	R37, R61	98	MP3
17	C38, C44, C46, C49, C52, C55, C56, C58, C61, C62, C117, C119	52	T11	99	MP3H2
		53	T11E1	100	MP3H2
		54	T11H1	101	MP3H2
18	Q7, Q8, Q10, Q11	55	T11H1	102	MP4
19	T1, T2, T3	56	T11H1	103	MP4H3
20	T1, T2, T3 Cores	57	R52, R68, R73, R75, R119	104	MP4H3
21	R2, R8, R14, R66, R87, R108	58	L23	105	MP4H3
22	R3, R10, R16, R67, R80, R99	59	L23R1		106 MP4H3
		60	T14		107 W1
23	R1, R6, R12, R45, R58, R64, R65, R81, R88, R103, R112, R113, R118	61	CR8, CR9		108 EI
		62	L24		
		63	L24R1		
		64	T12		
24	R4, R9, R15	65	T12 CORE		
25	R7, R13, R18, R38, R43, R49, R54, R77, R82, R102	66	R51, R71		
		67	L10, L11, L12, L13, L16, L18		
26	R5, R11, R17, R39, R59, R69	68	R42		
		69	R120		
27	CR4, CR5	70	R41, R56		
71	T8, T9, T10				
72	T8R1, T9R1, T10R1				

Section II. REPAIR PARTS LIST

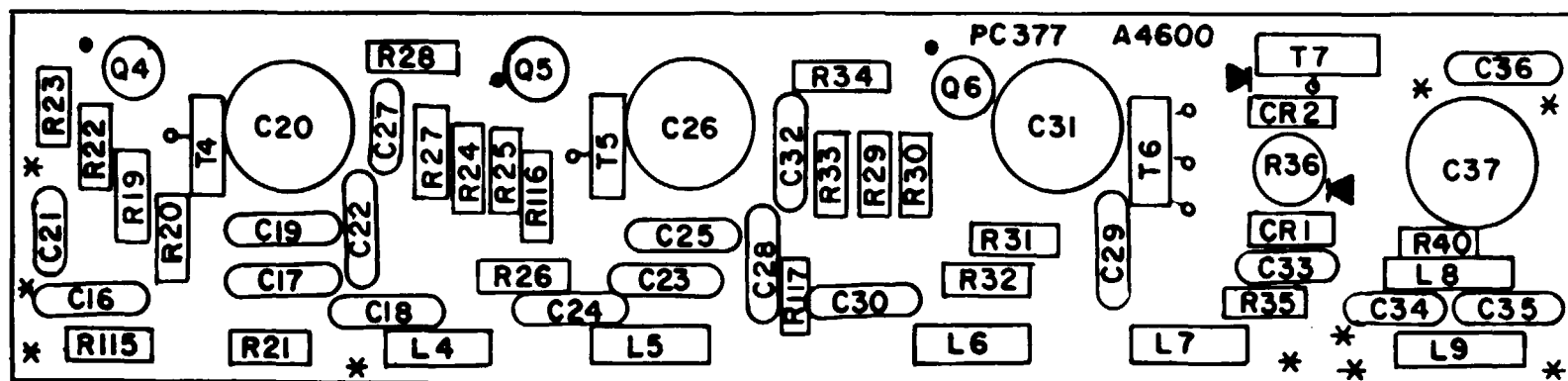
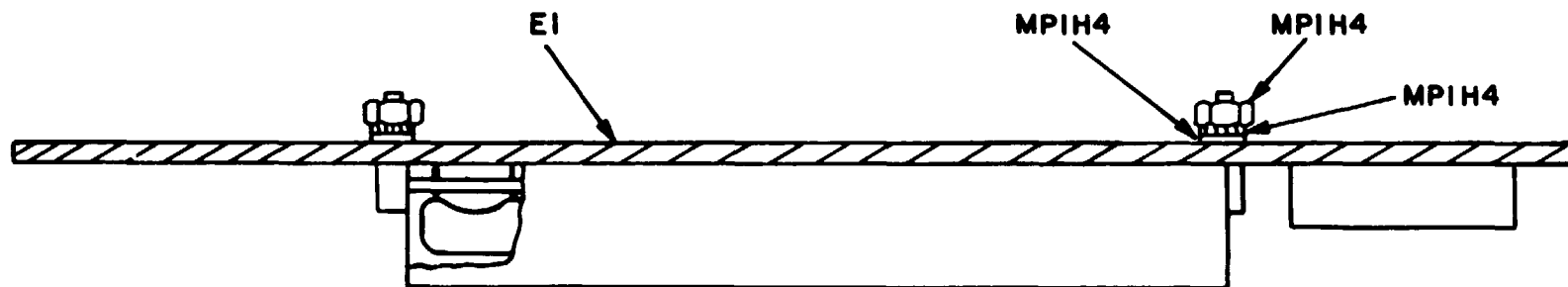

EL 5895 -288 -24P -TM - 28

Figure 28. 120 MHZ Generator Circuit Card

Section II. REPAIR PARTS LIST

KEY to fig. 28

Index	Ref Des	Index	Ref Des	Index	Ref Des
1	R22, R27				
2	Q4, Q5				
3	T4, T5				
4	T4R1				
5	T5R1				
6	C20, C26, C31				
7	C17, C18, C21, C22, C23, C24, C27, C28, C29, C30, C32				
8	R23, R28, R34				
9	R19, R24, R32				
10	R20, R25				
11	R30, R116				
12	R33, R40, R115, R117				
13	R29				
14	Q6				
15	R31				
16	T6				
17	T6R1				
18	T7				
19	T7R1				
20	CR1, CR2				
21	R36				
22	C19, C25, C36				
23	C37				
24	L8, L9				
25	C34, C35				
26	C16, C33				
27	R35				
28	L7				
29	L4, L5, L6				
30	R21, R26				
31	PC1				

Section II REPAIR PARTS LIST

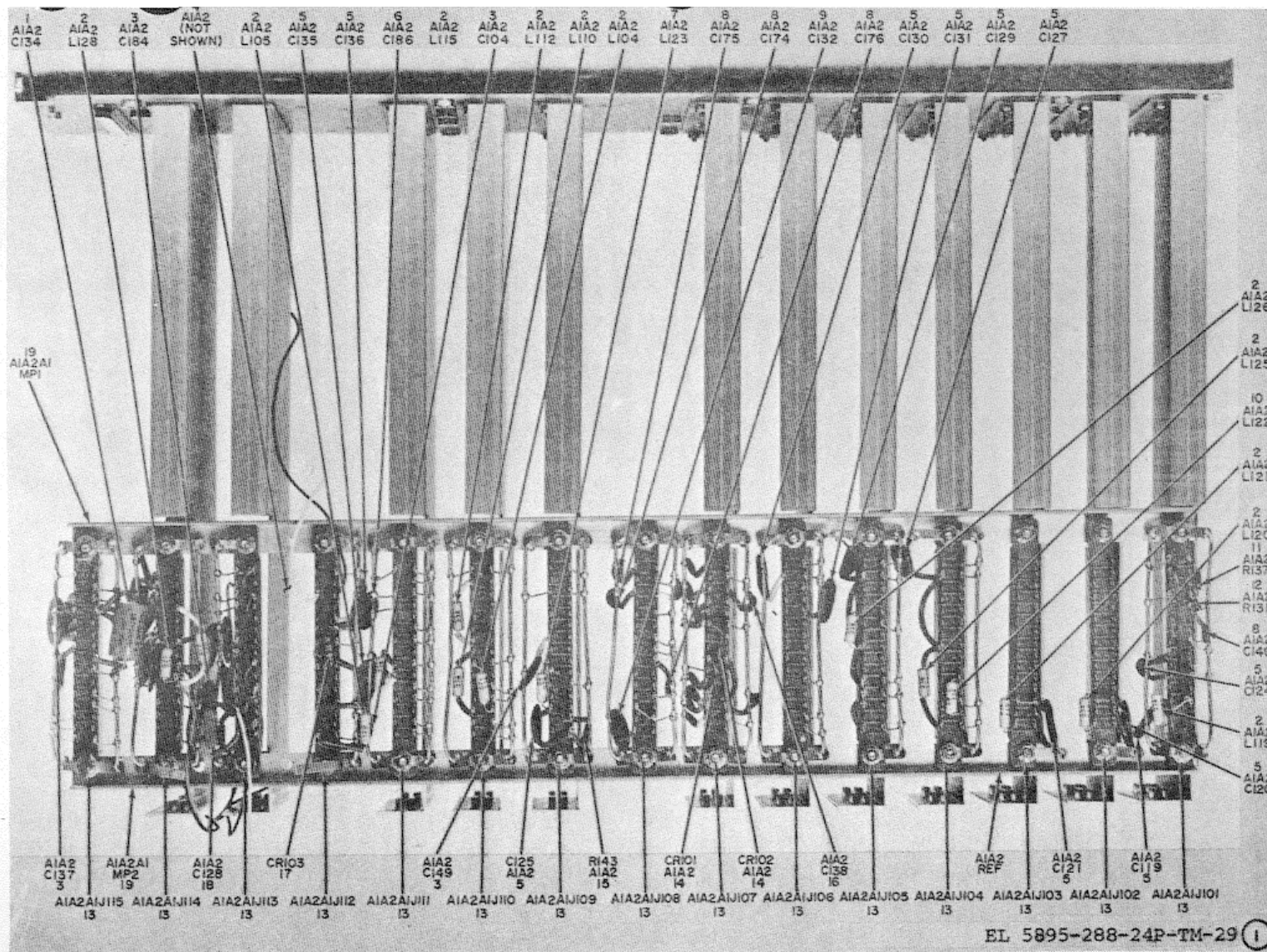

Figure 29. Multimode Exciter Subassembly A1A2 (sheet 1 of 6)

Section II REPAIR PARTS LIST

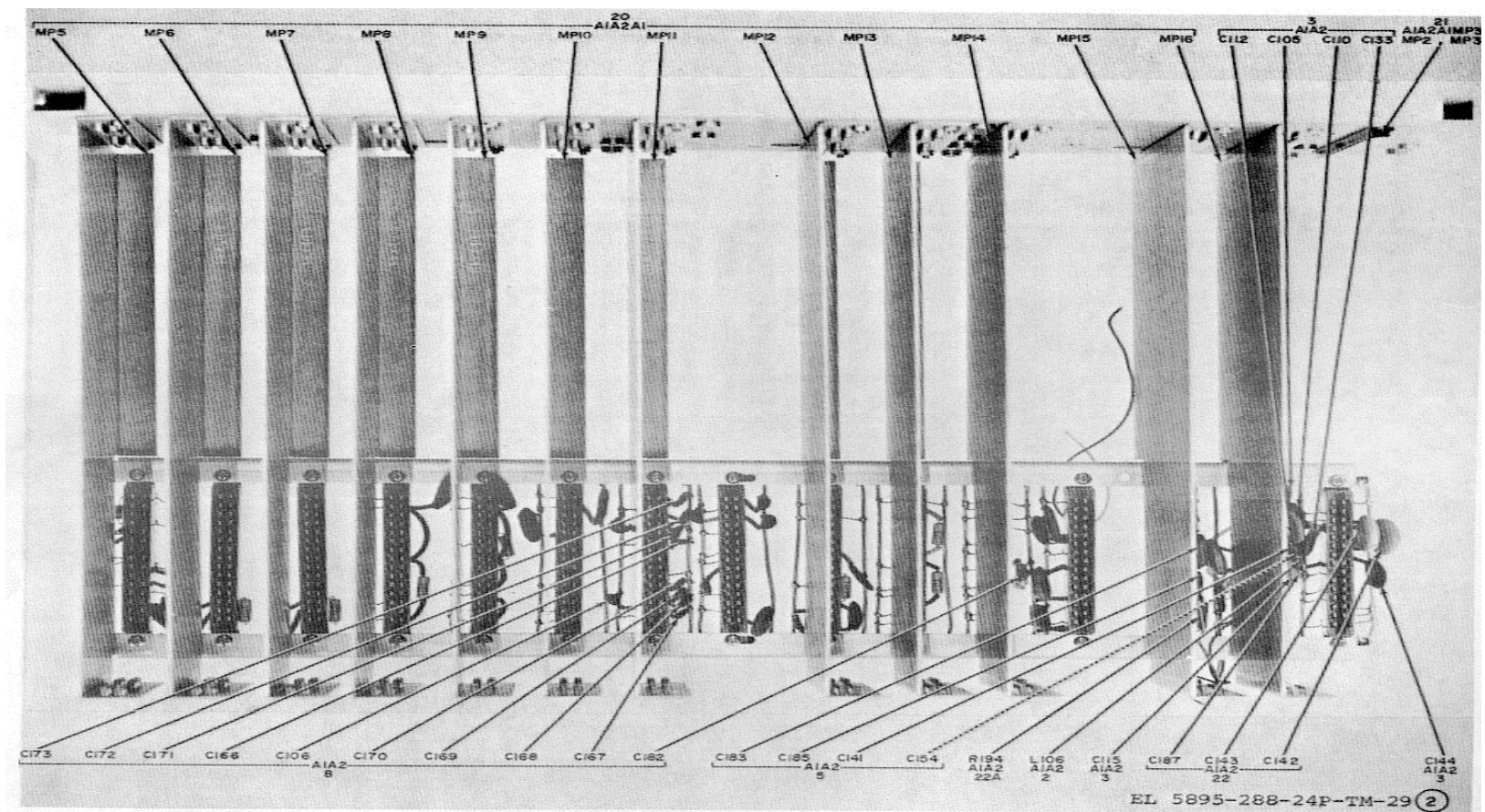

Figure 29. Multimode Exciter Subassembly A1A2 (Sheet 2 of 6)

Section II REPAIR PARTS LIST

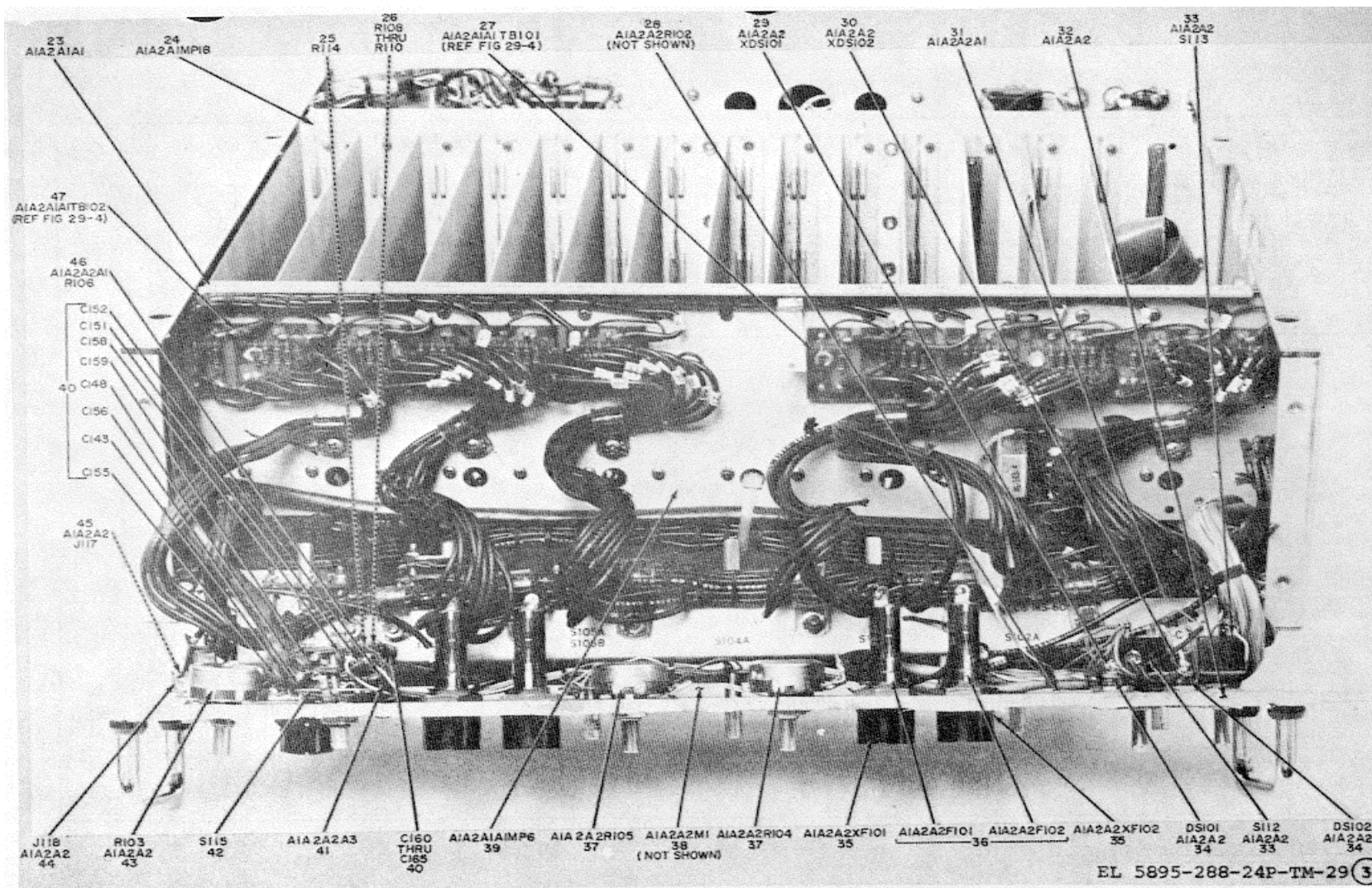
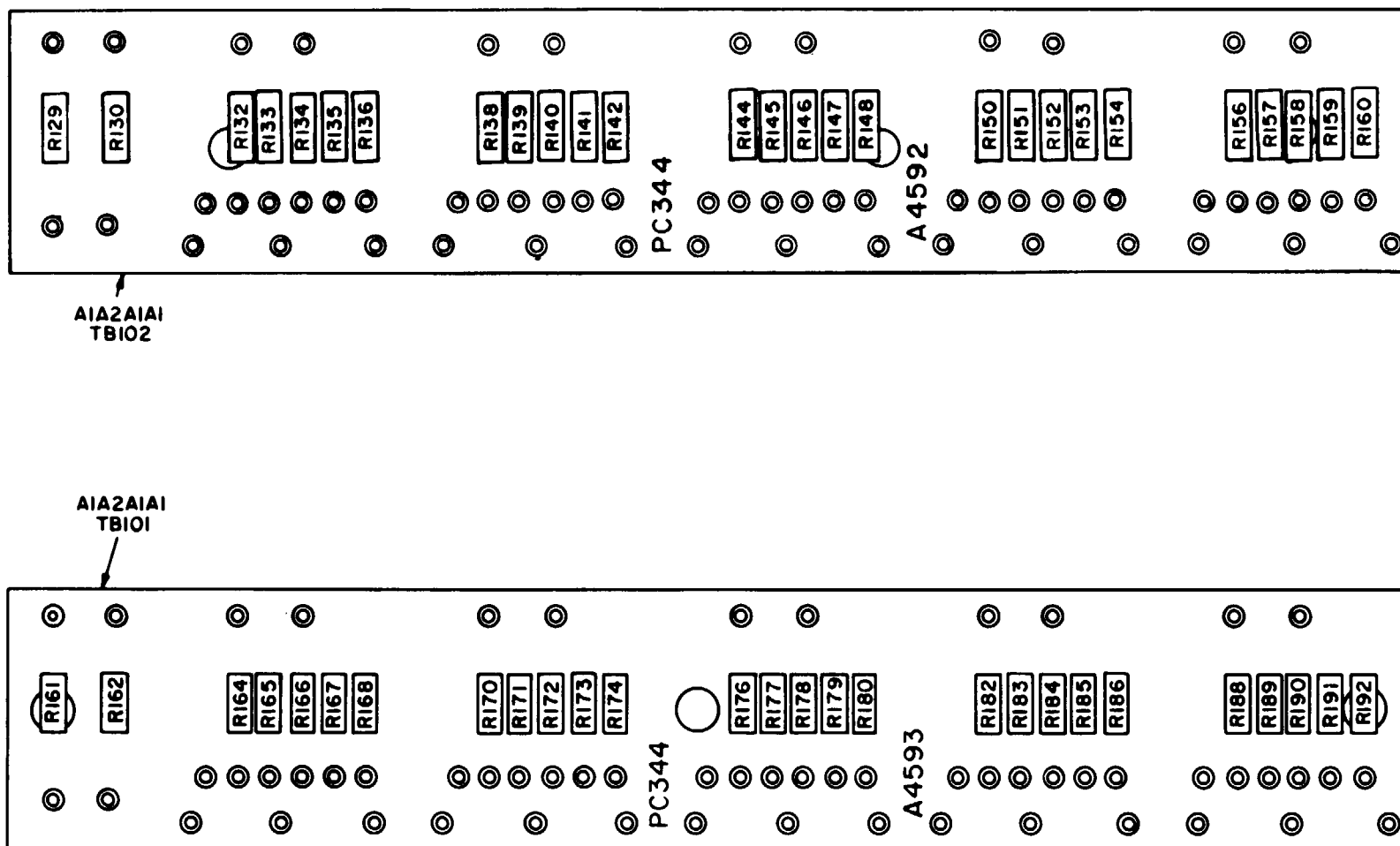

Figure 29. Multimode Exciter Subassembly A1A2 (Sheet 3 of 6)

Section II REPAIR PARTS LIST



EL 5895-288-24P-TM-29 (4)

Figure 29. Multimode Exciter Subassembly A1A2 (Sheet 4 of 6)

Section II REPAIR PARTS LIST

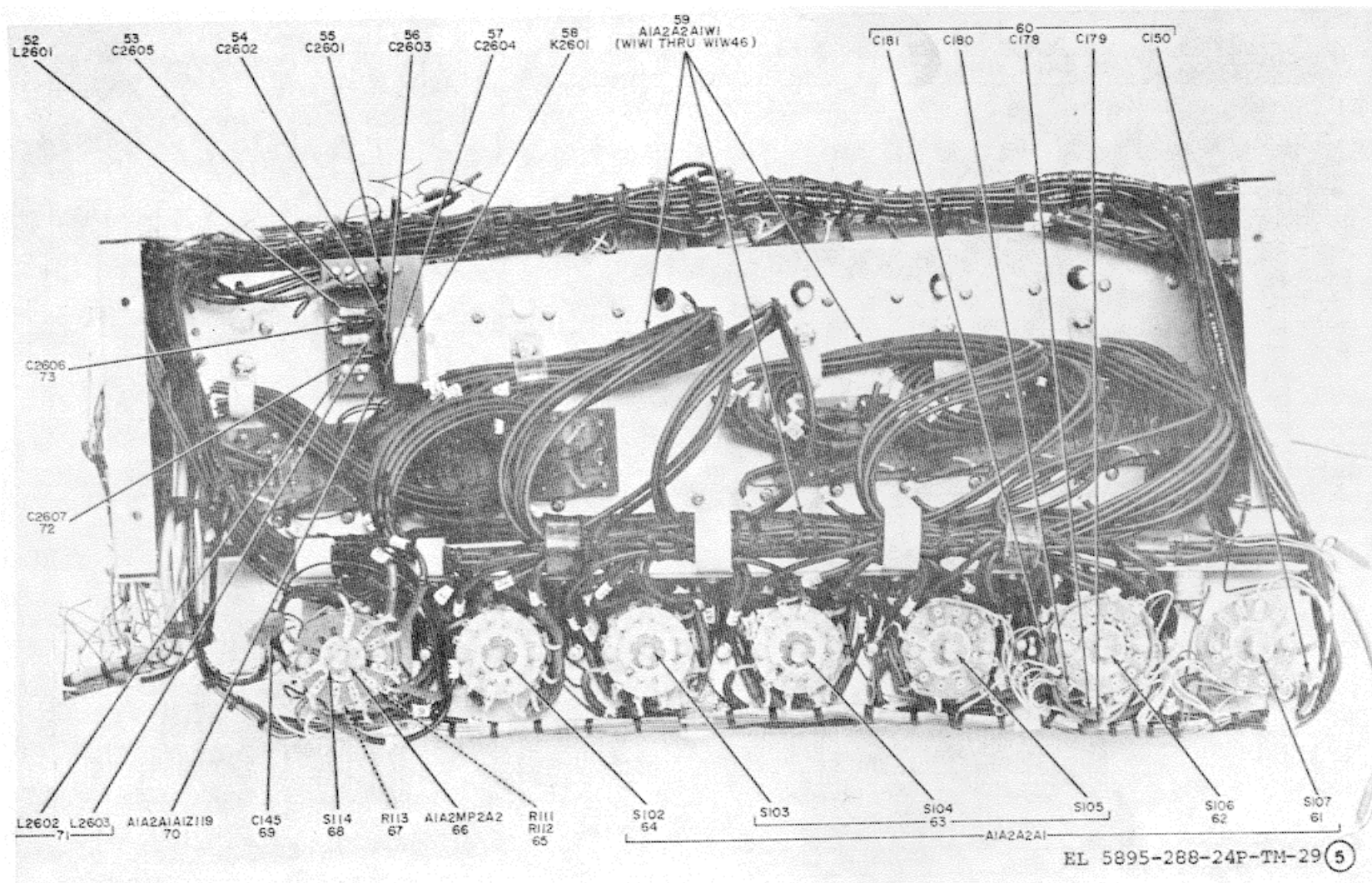

Figure 29. Multimode Exciter Subassembly A1A2 (Sheet 5 of 6)

Section II. REPAIR PARTS LIST

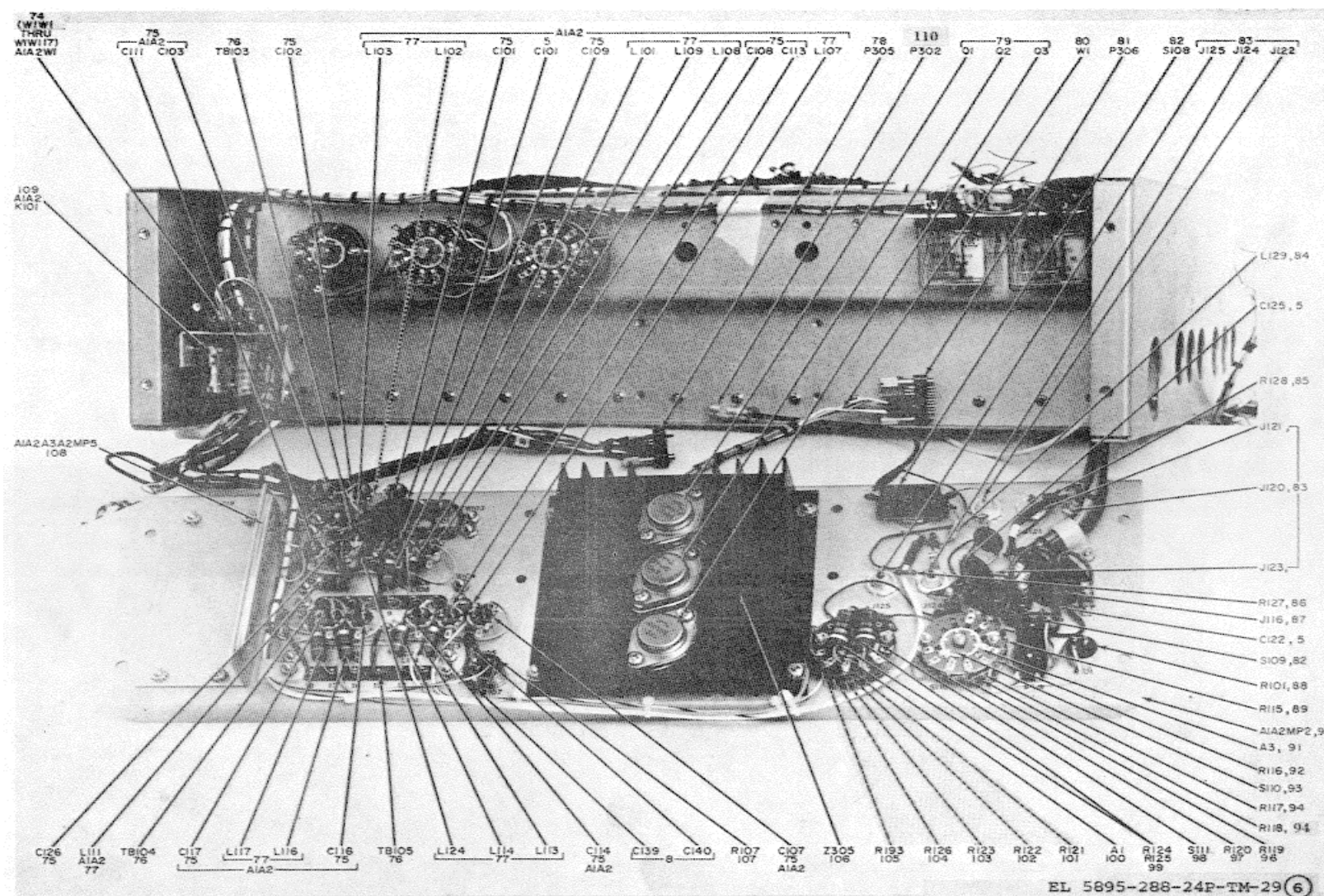

Figure 29. Multimode Exciter Subassembly A1IA2 (Sheet 6 of 6)

Section II. REPAIR PARTS LIST

KEY to Fig. 29

Index	Ref Des	Index	Ref Des	Index	Ref Des
48	R129				
49	R130, R132, R133, R134, R135, R136, R138, R139, R140, R141, R142, R144, R145, R146, R147, R148, R150, R151, R152, R153, R154, R156, R157, R158, R159, R160				
50	R161				
51	R162, R164, R165, R166, R167, R168, R170, R171, R172, R173, R174, R176, R177, R178, R179, R180, R182, R183, R184, R185, R186, R188, R189, R190, R191, R192				

161/(162 blank)

Section II REPAIR PARTS LIST

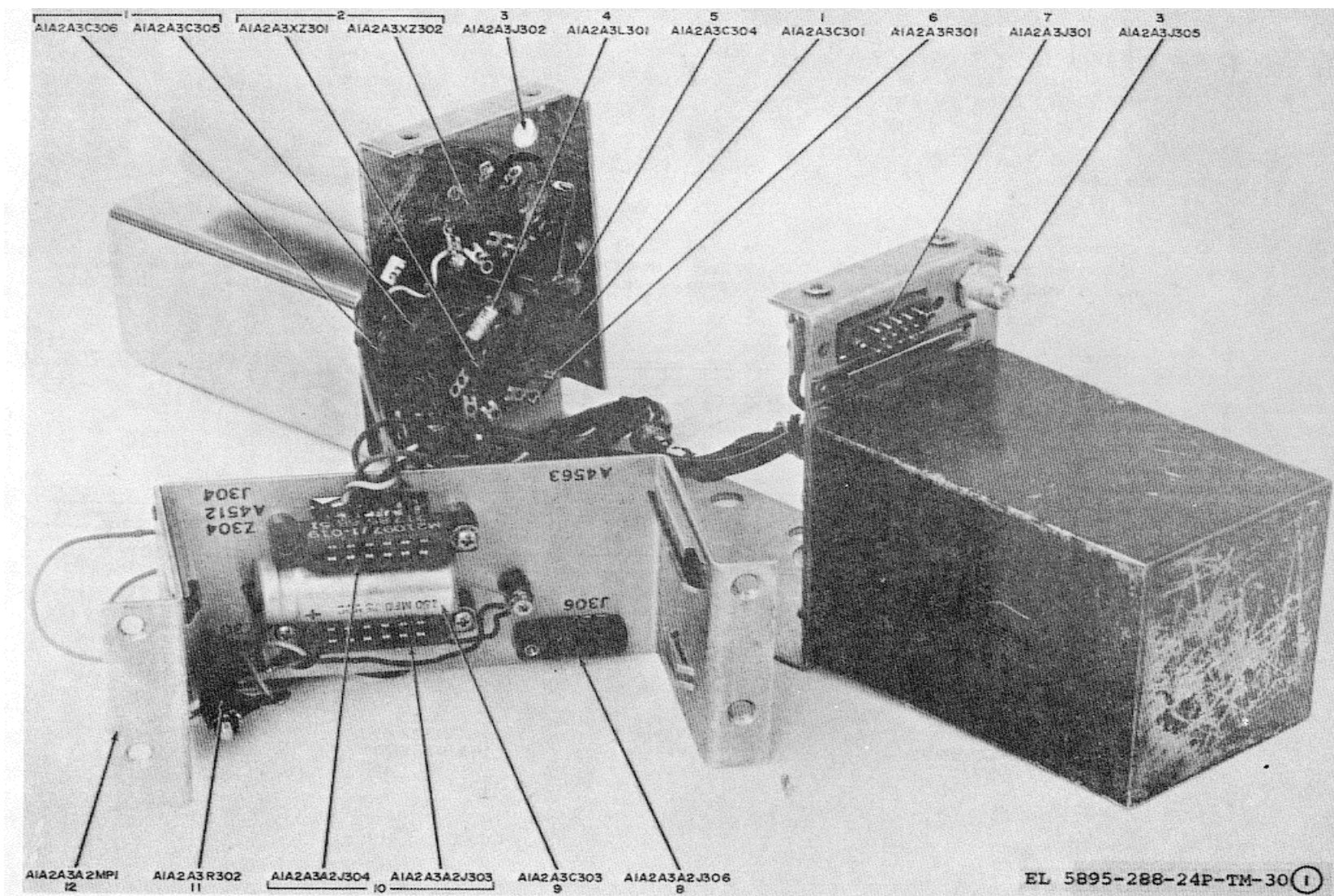
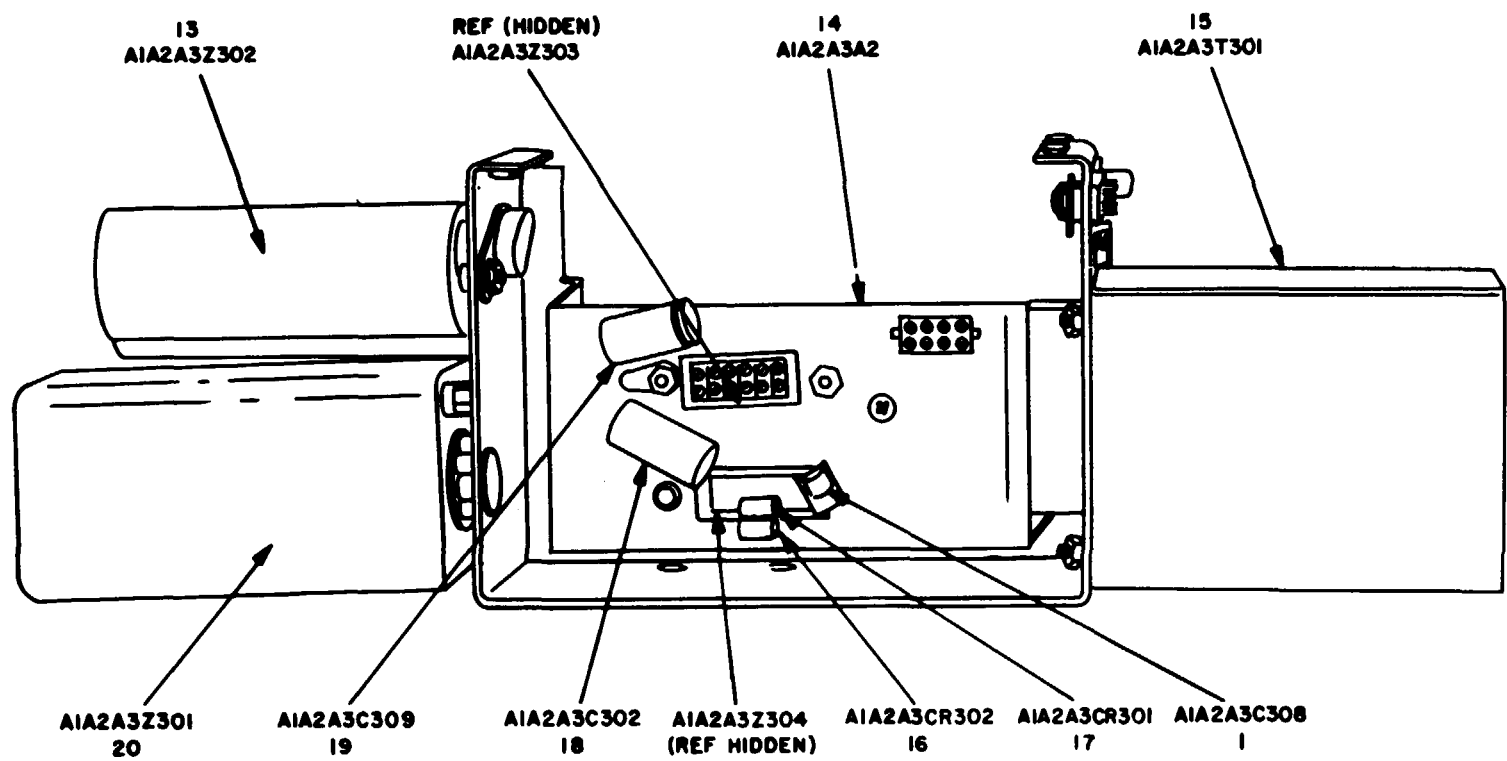

Figure 30. Power Supply (Sheet 1 of 2)

Section II REPAIR PARTS LIST



EL 5895-288-24P-TM-30 (2)

Figure 30. Power Supply (Sheet 2 of 2)

Section II Repair Parts List

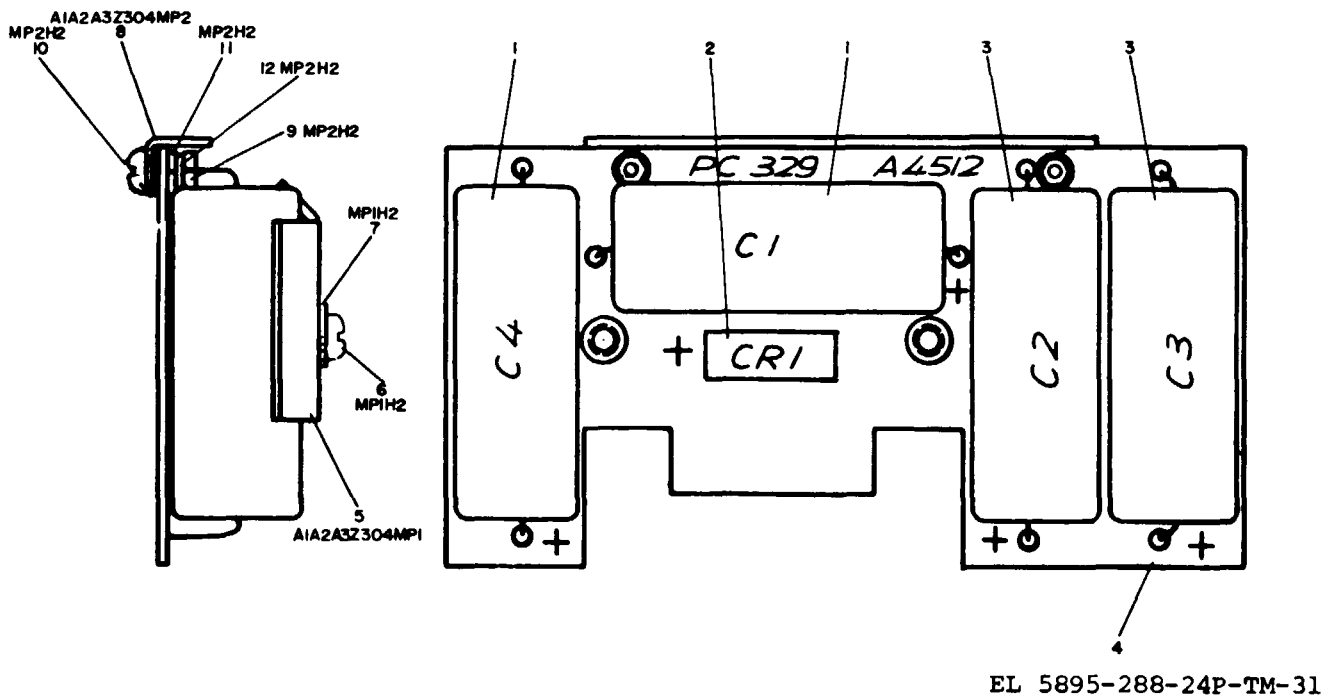

EL 5895-288-24P-TM-31

Figure 31. Circuit Card A Z304

Section II REPAIR PARTS LIST

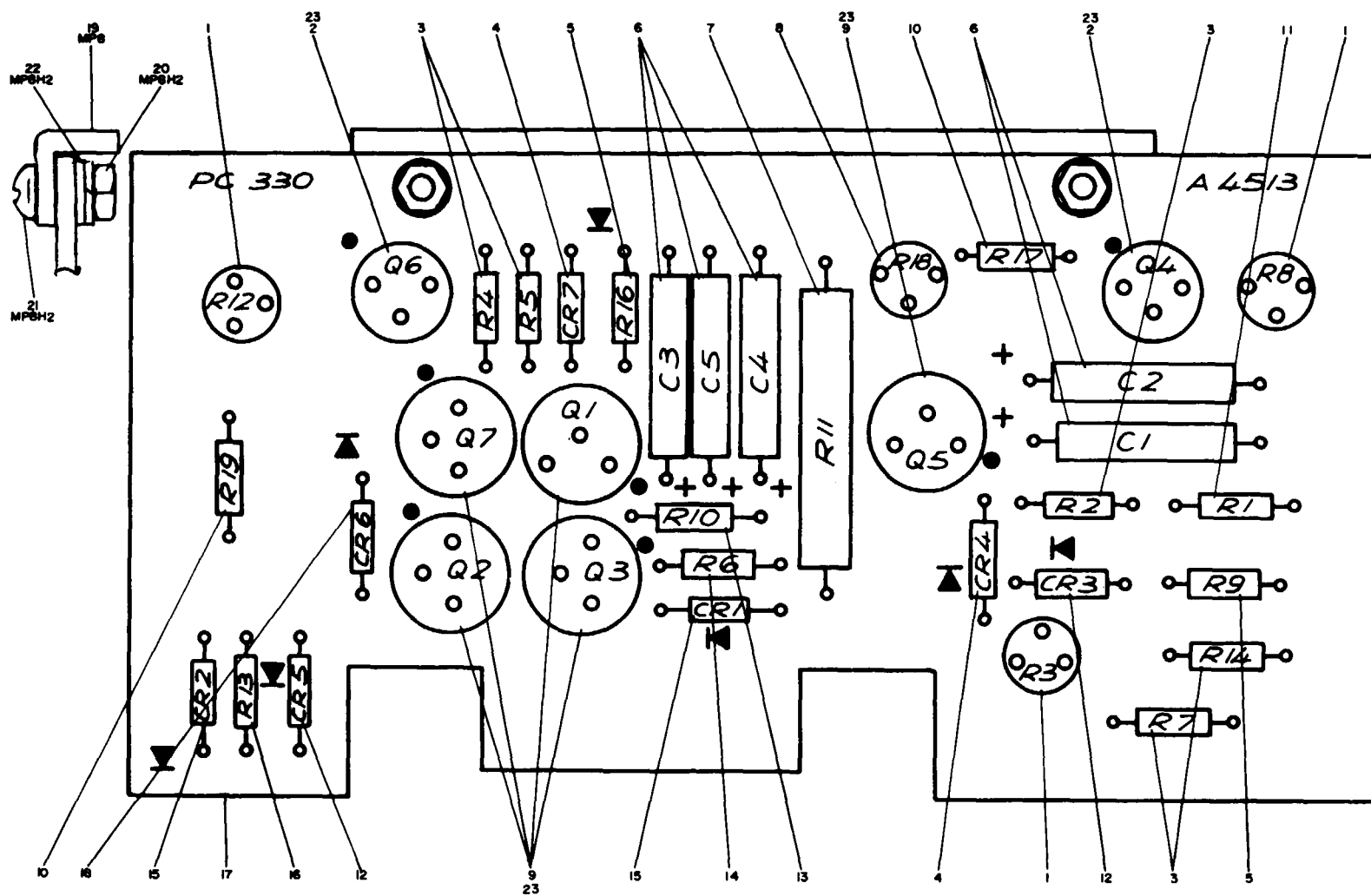

EL 5895-288-24P-TM-32

Figure 32. Circuit Card B Z303

Section II REPAIR PARTS LIST

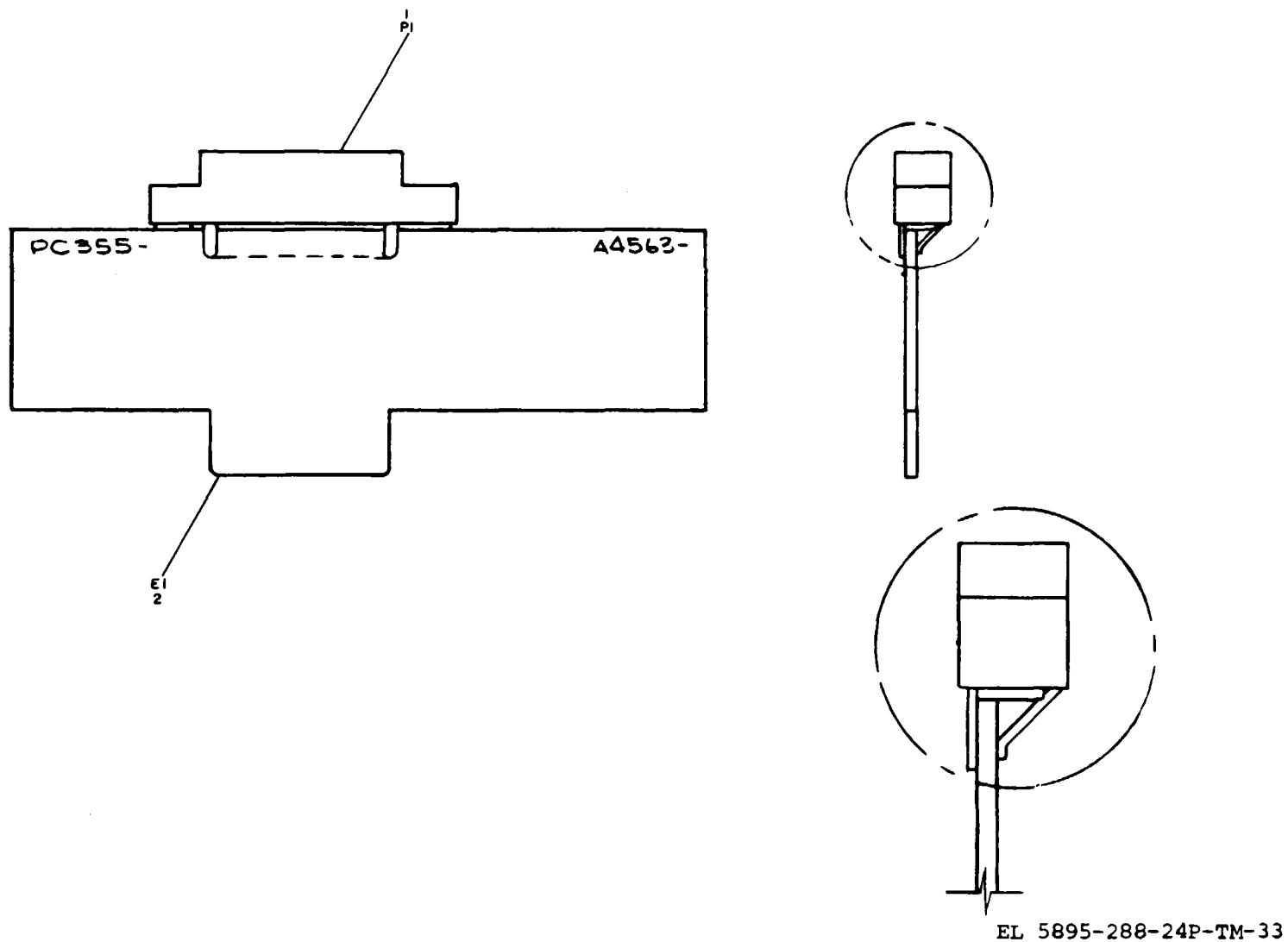
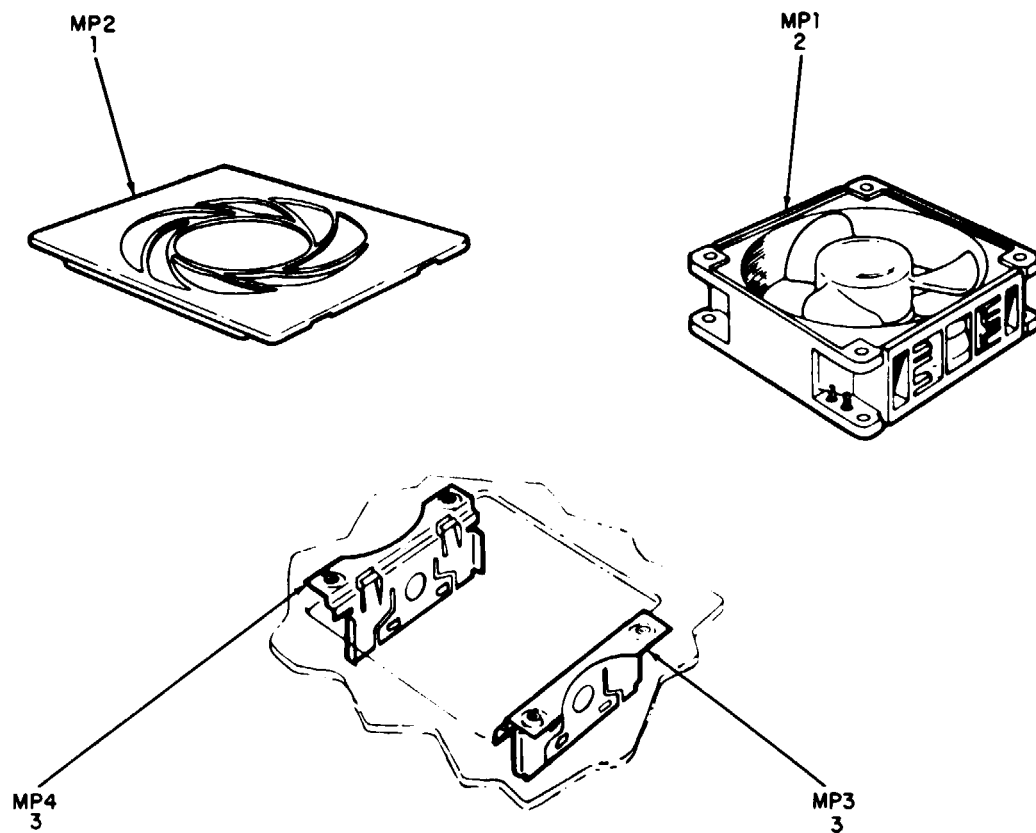

Figure 33. Riser Circuit Card

Section II REPAIR PARTS LIST



EL 5895-288-24P-TM-34

Figure 34. Axial Fan

Section II REPAIR PARTS LIST

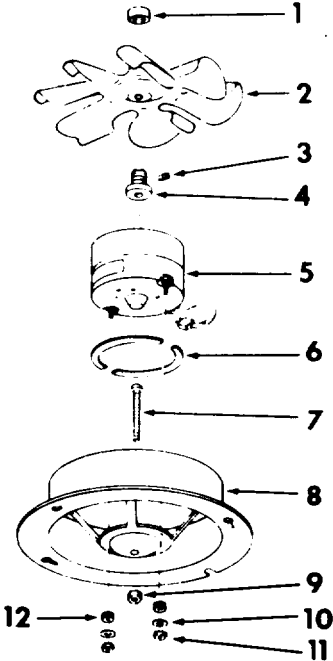

EL 5895-288-24P-TM-35

Figure 35. Exhaust Duct

Section II REPAIR PARTS LIST

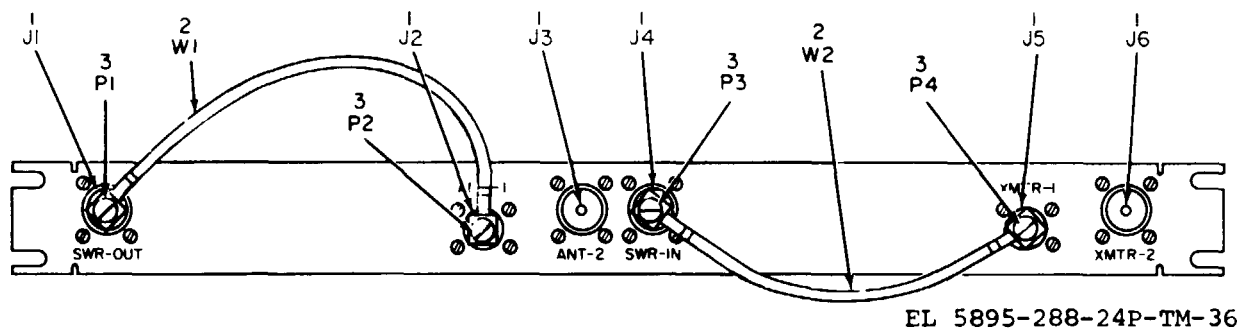

Figure 36. Antenna Patch Panel

Section II REPAIR PARTS LIST

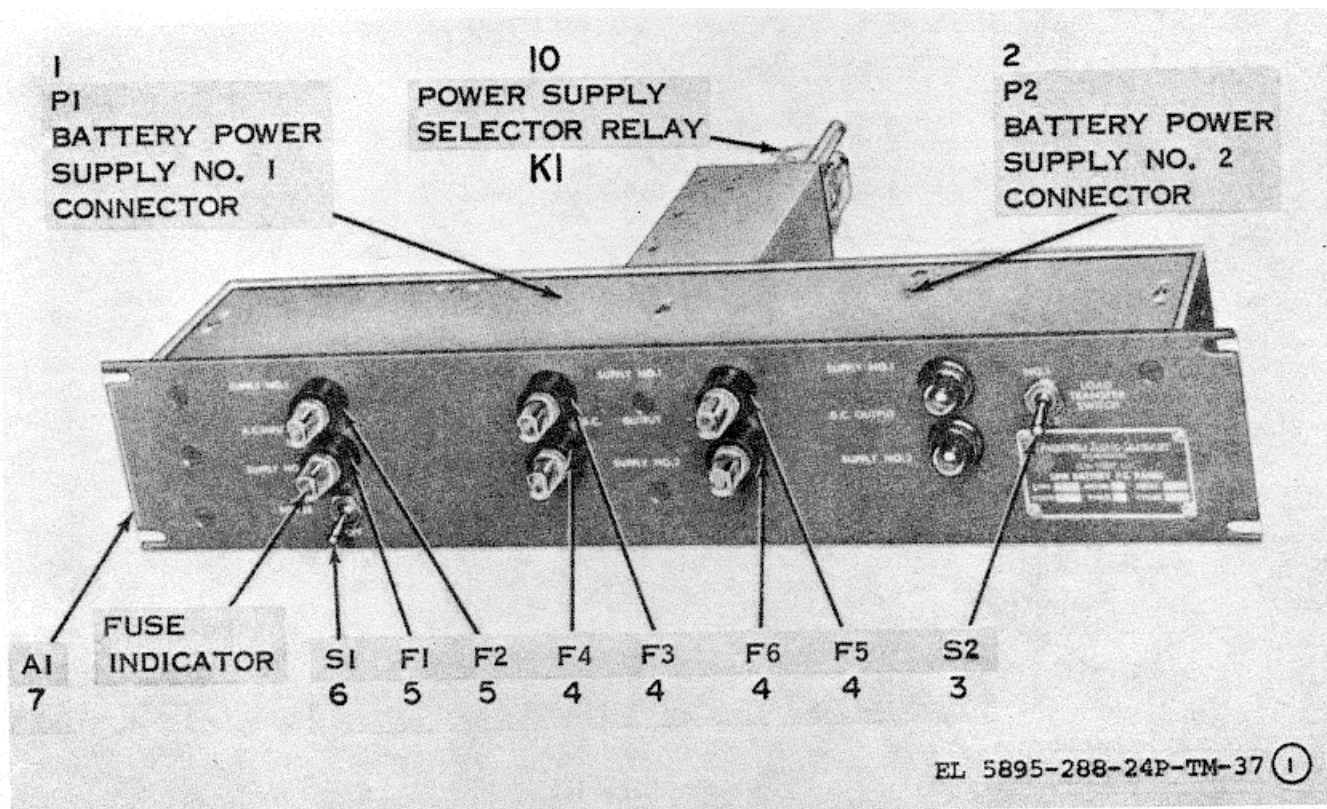

Figure 37. Line Battery Supply No. 1 Panel, NRC Type 227 (Sheet 1 of 2)

Section II REPAIR PARTS LIST

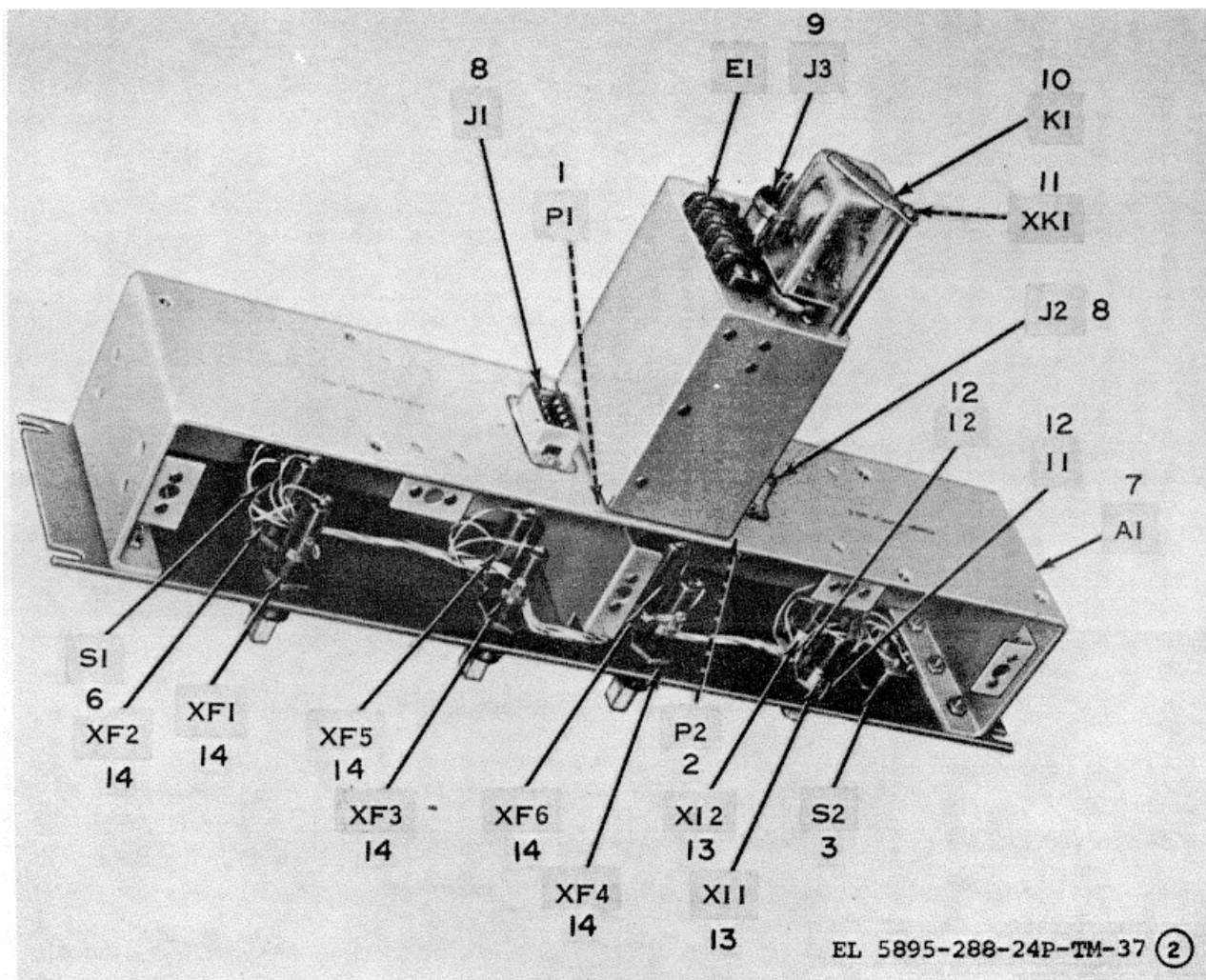
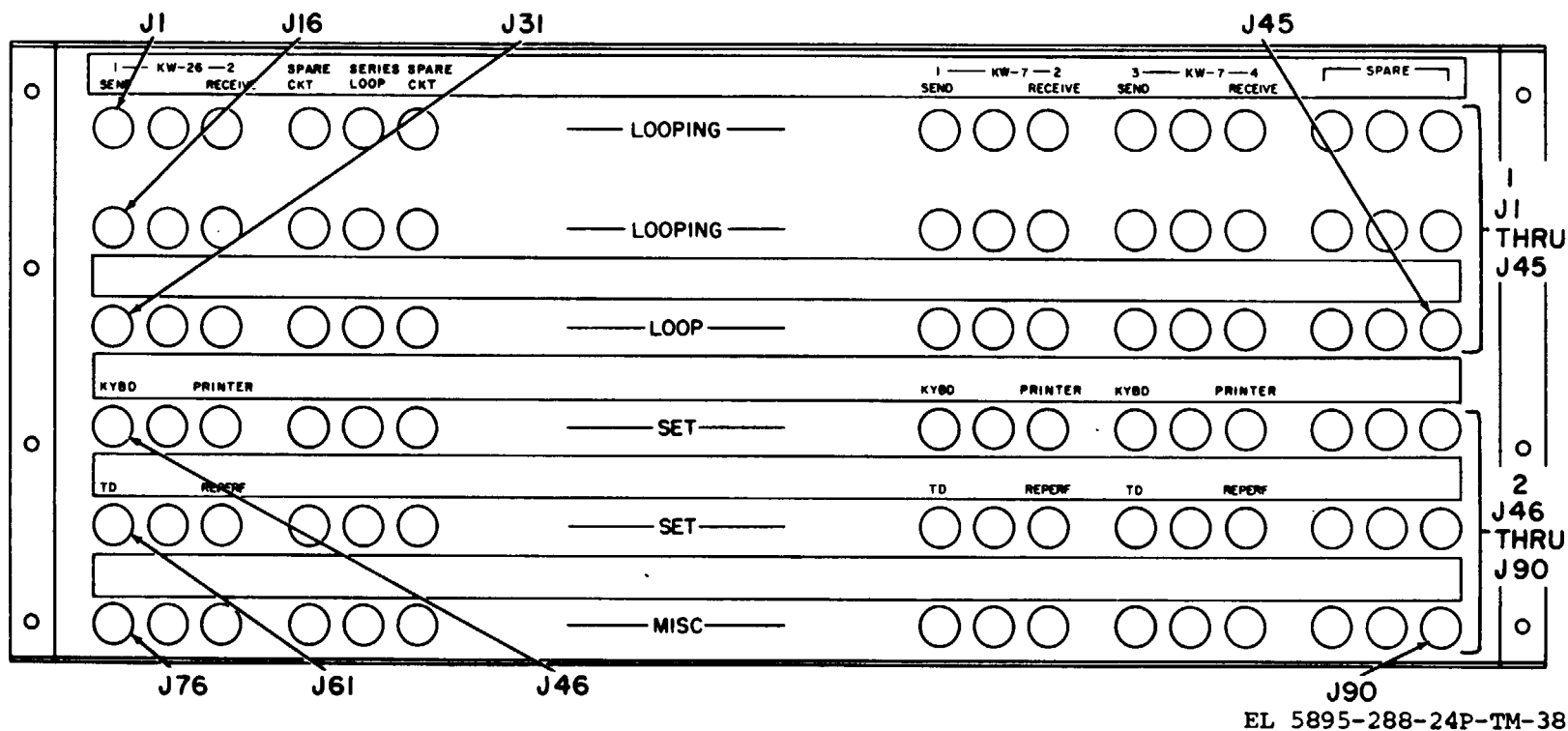

Figure 37. Line Battery Supply No. 1 Panel, NRC Type 227 (Sheet 2 of 2)

Section II REPAIR PARTS LIST



EL 5895-288-24P-TM-38

Figure 38. Red Patch Panel

Section II REPAIR PARTS LIST

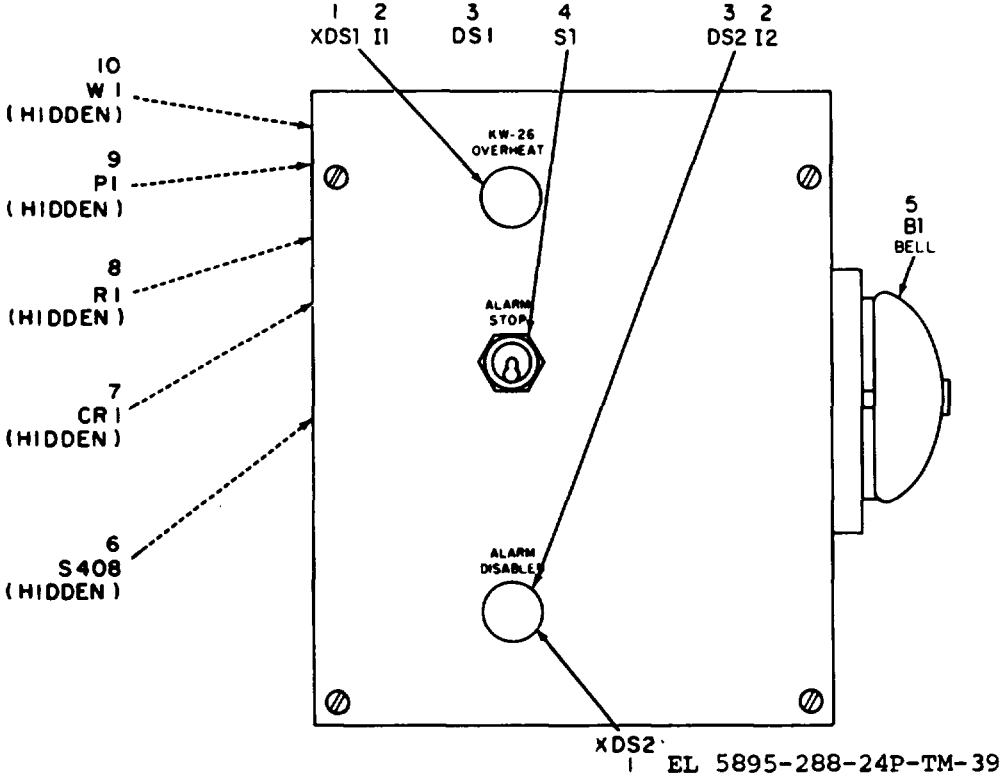

Figure 39. Alarm Unit

Section II REPAIR PARTS LIST

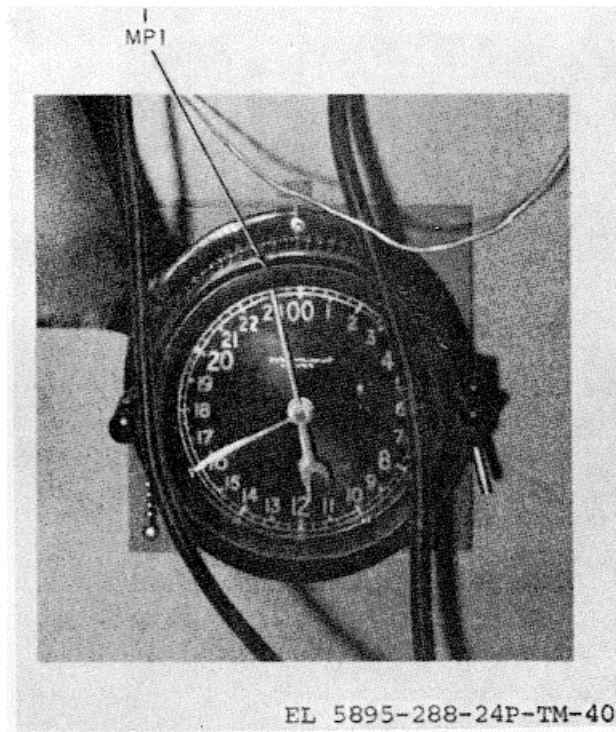

Figure 40. Clock

Section II REPAIR PARTS LIST

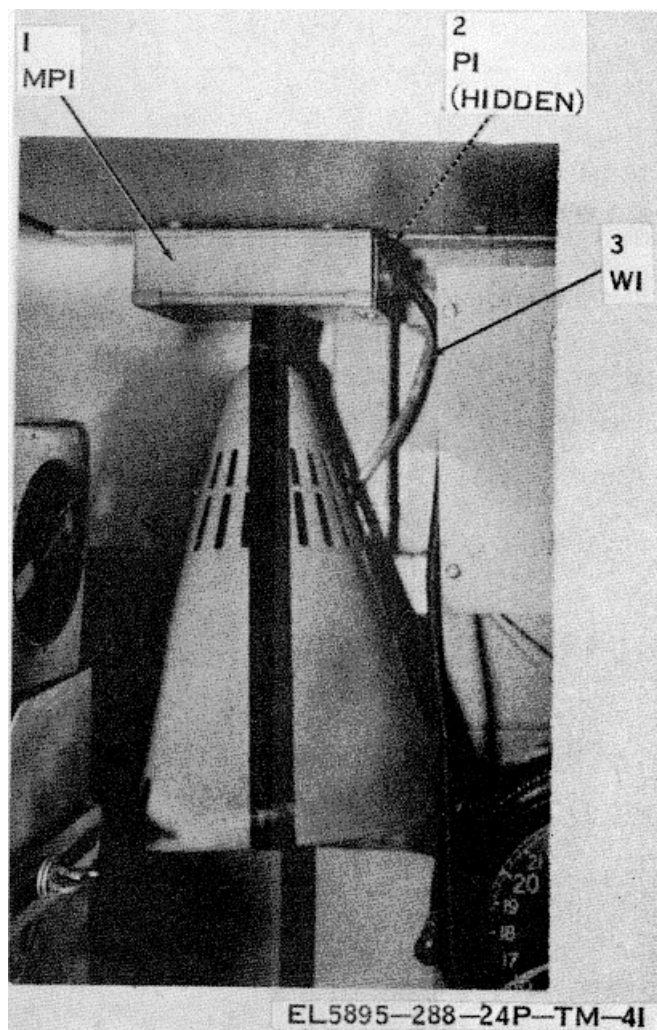
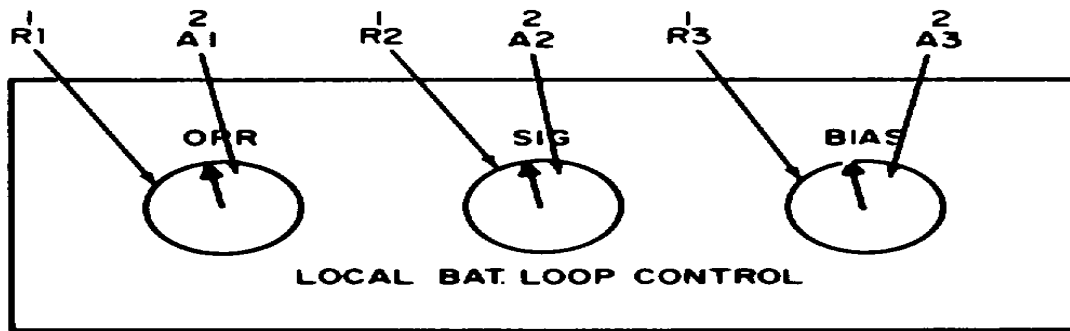
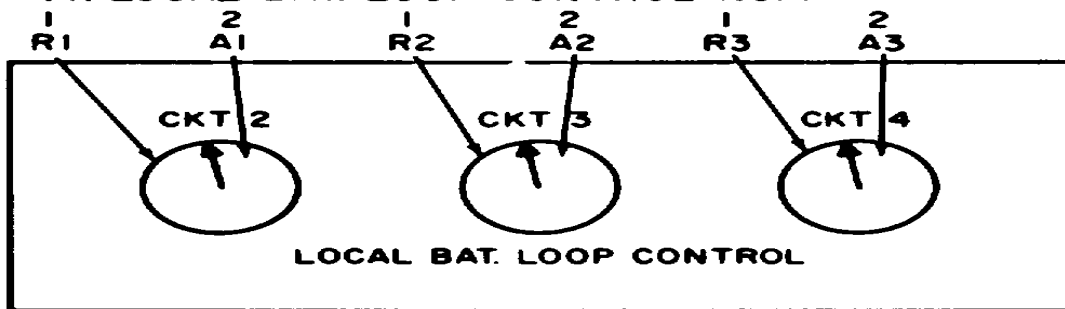

Figure 41. Spotlight

SECTION II. REPAIR PARTS LIST



A. LOCAL BAT. LOOP CONTROL NO. 1



B. LOCAL BAT. LOOP CONTROL NO. 2

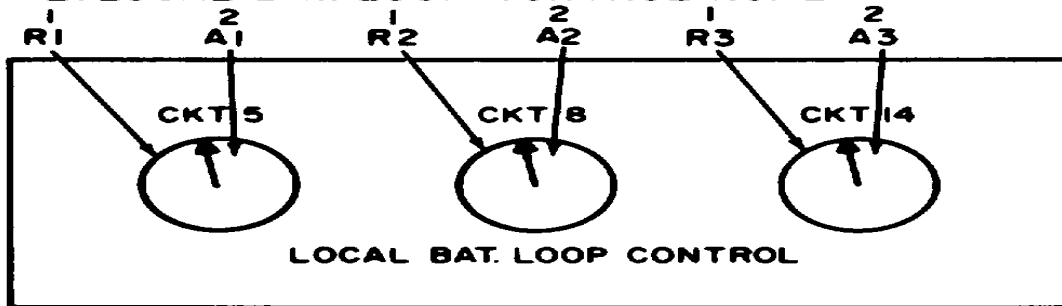

C. LOCAL BAT. LOOP CONTROL NO. 3

EL 5895-288-24P-TM-42

Figure 42. Local Battery Loop Control No. 3

SECTION II. REPAIR PARTS LIST

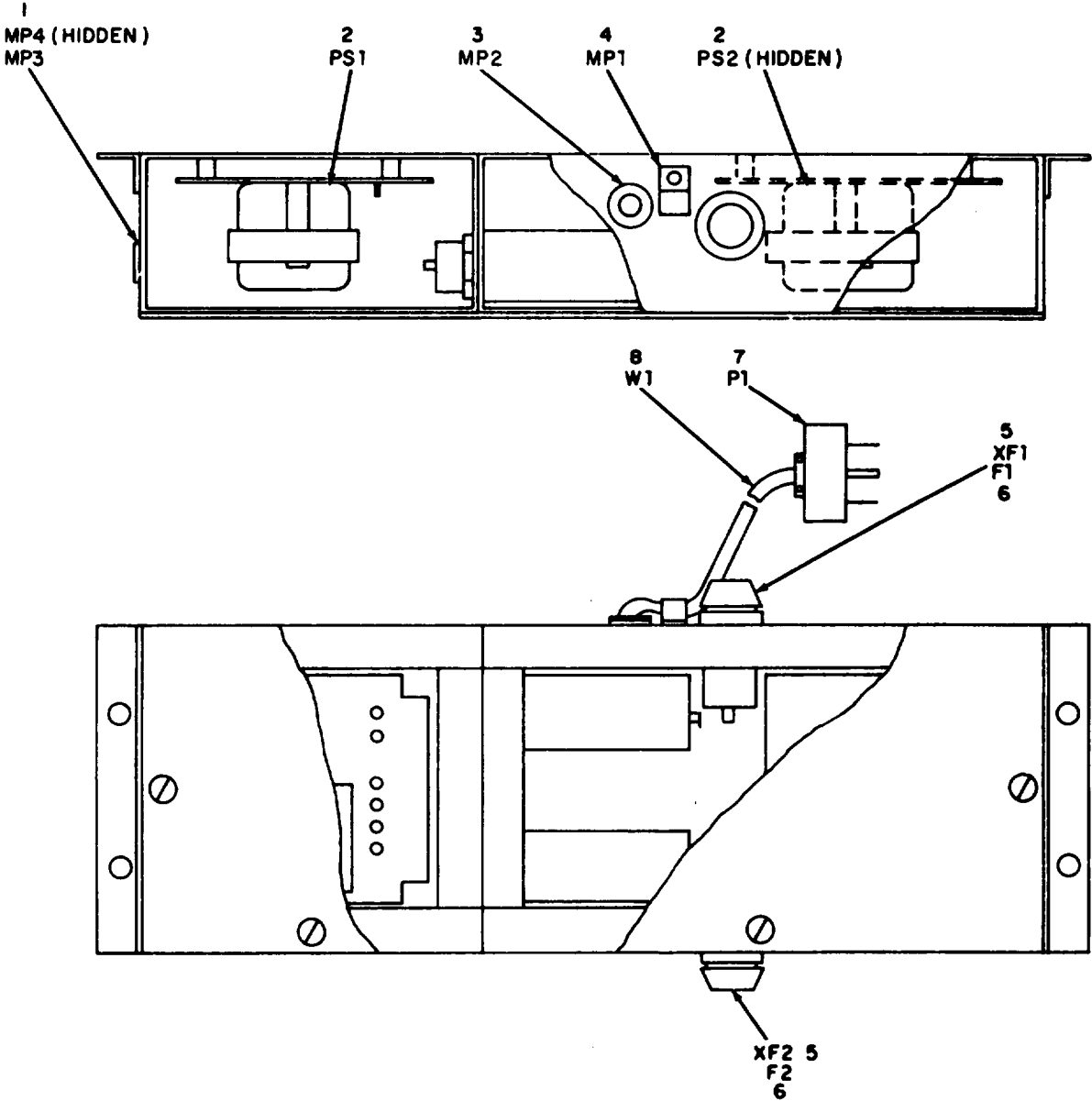

EL 5895-288-24P-TM-43

Figure 43. Red/Black Power Supply

SECTION II. REPAIR PARTS LIST

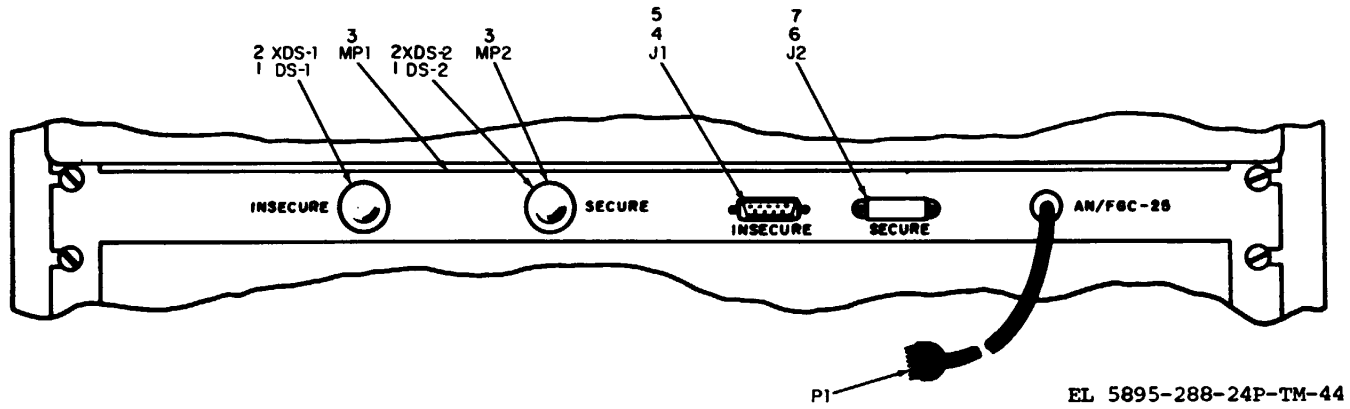

EL 5895-288-24P-TM-44

Figure 44. Secure No. 1 Patch Panel

SECTION II. REPAIR PARTS LIST

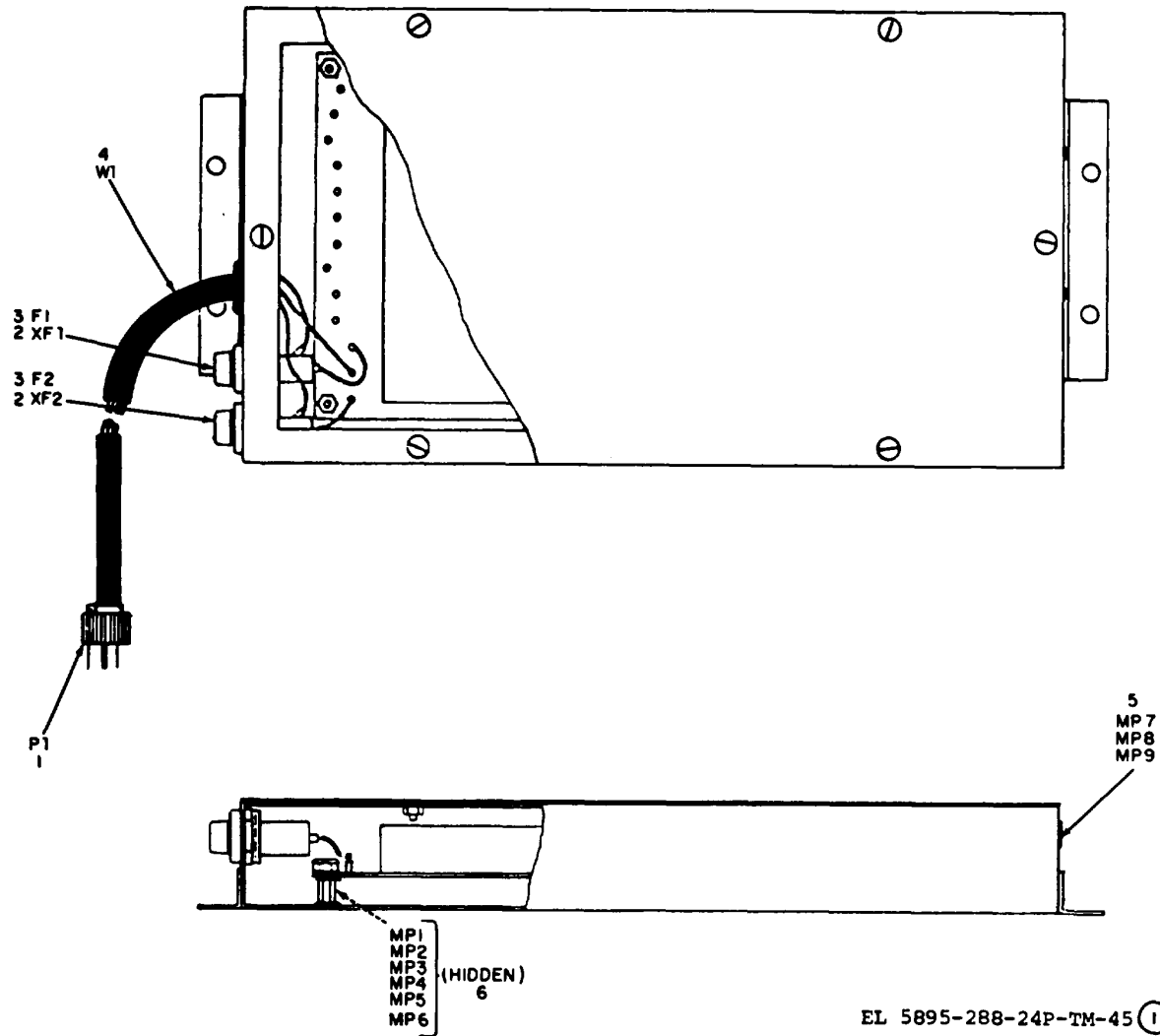

EL 5895-288-24P-TM-45 (1)

Figure 45. Low Level Interface No. 1 Box (Sheet 1 of 2)

SECTION II. REPAIR PARTS LIST

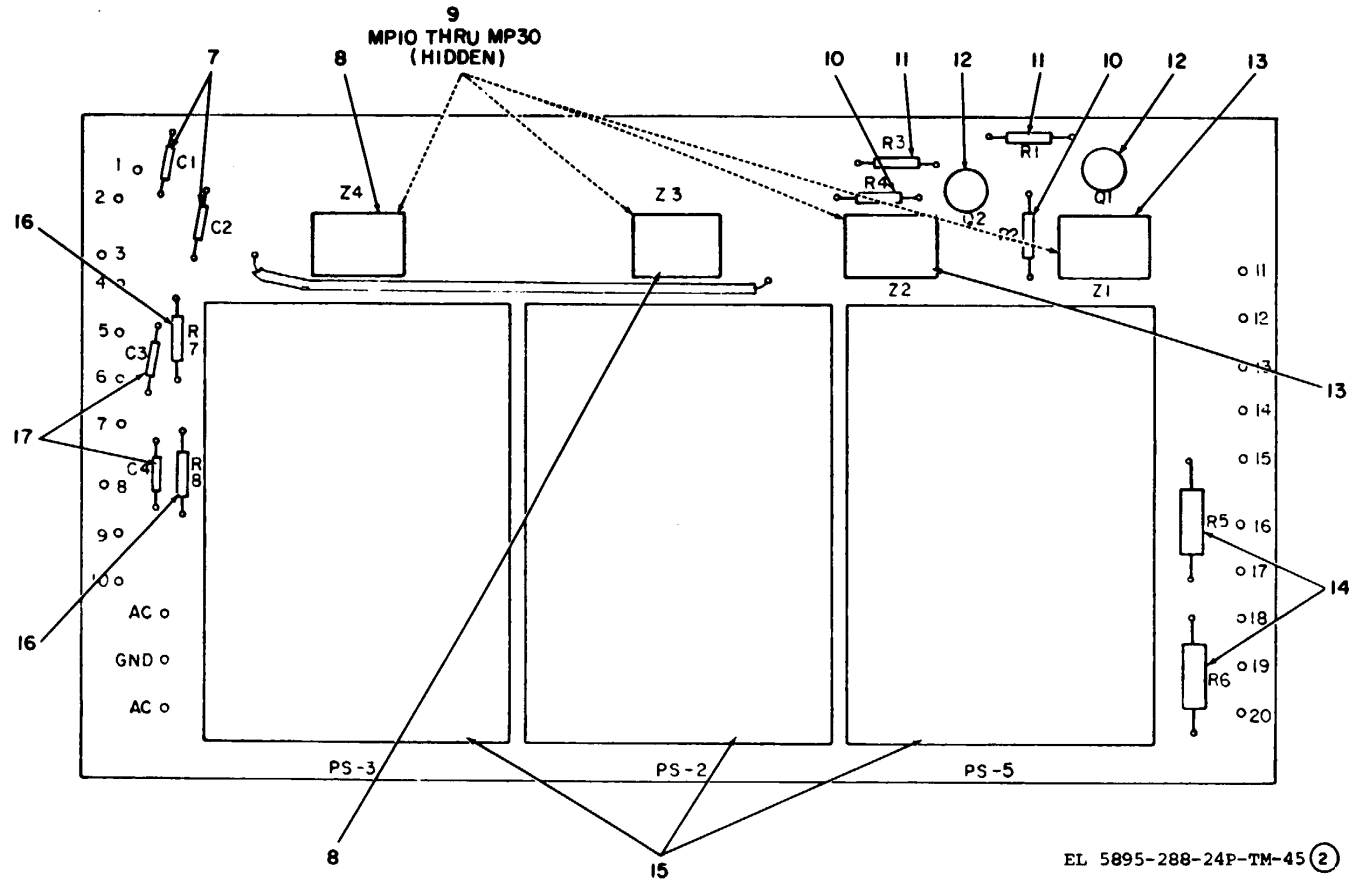
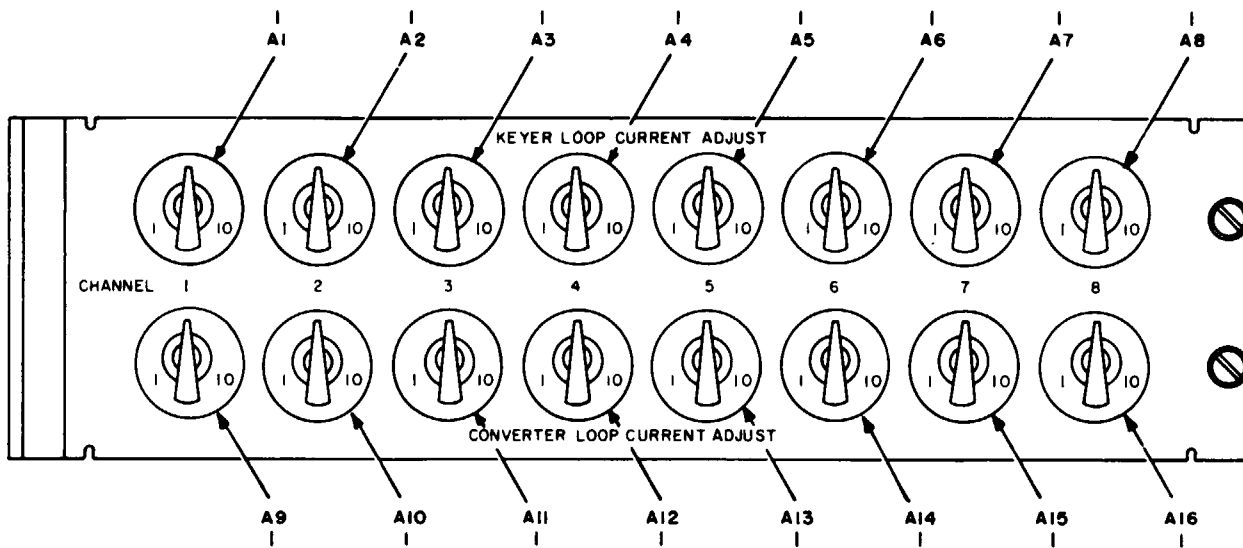

Figure 45. Low Level Interface No. 1 Box (Sheet 2 of 2)

SECTION II. REPAIR PARTS LIST



EL 5895-288-24P-TM-46 ①

Figure 46. Current Limiter Panel (Sheet 1 of 21).

SECTION II. REPAIR PARTS LIST

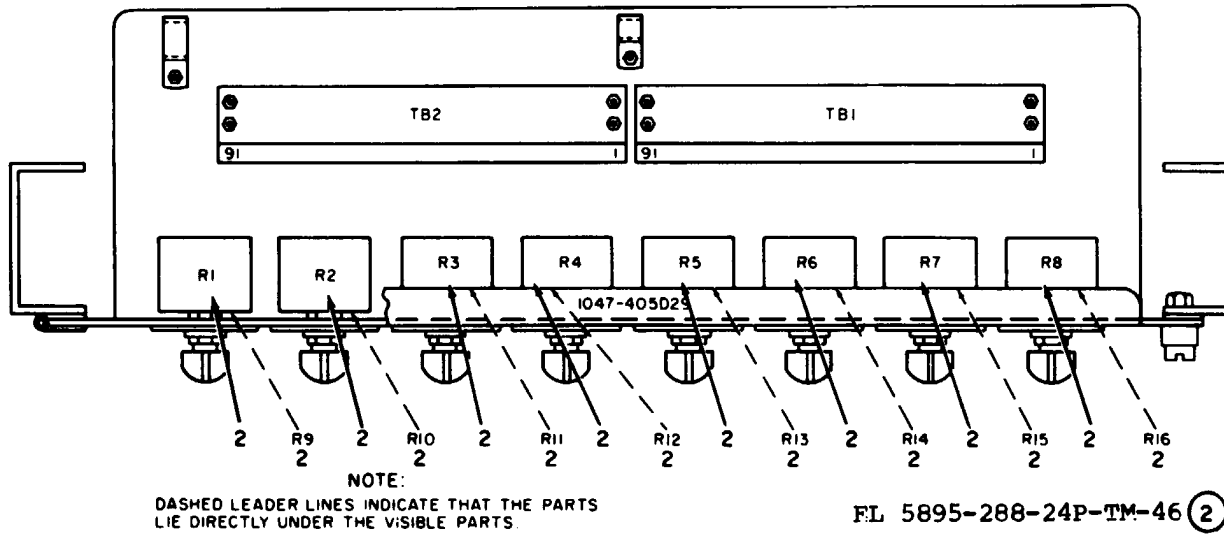

Figure 46. Current Limiter Panel (Sheet 2 of 2)

SECTION II. REPAIR PARTS LIST

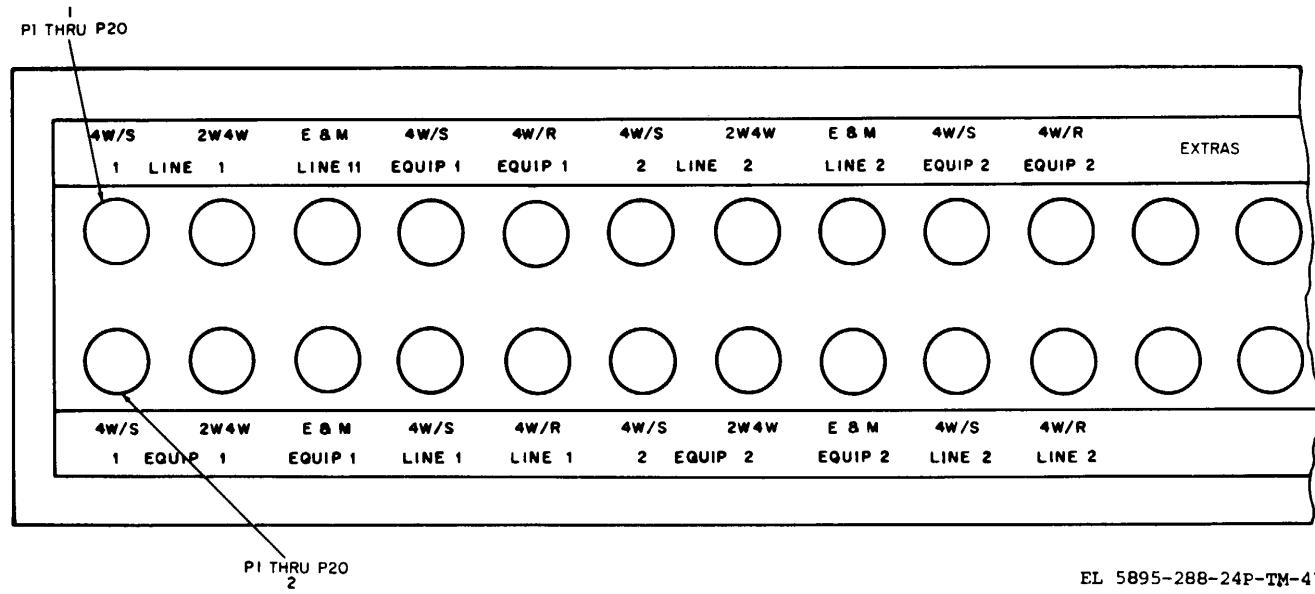
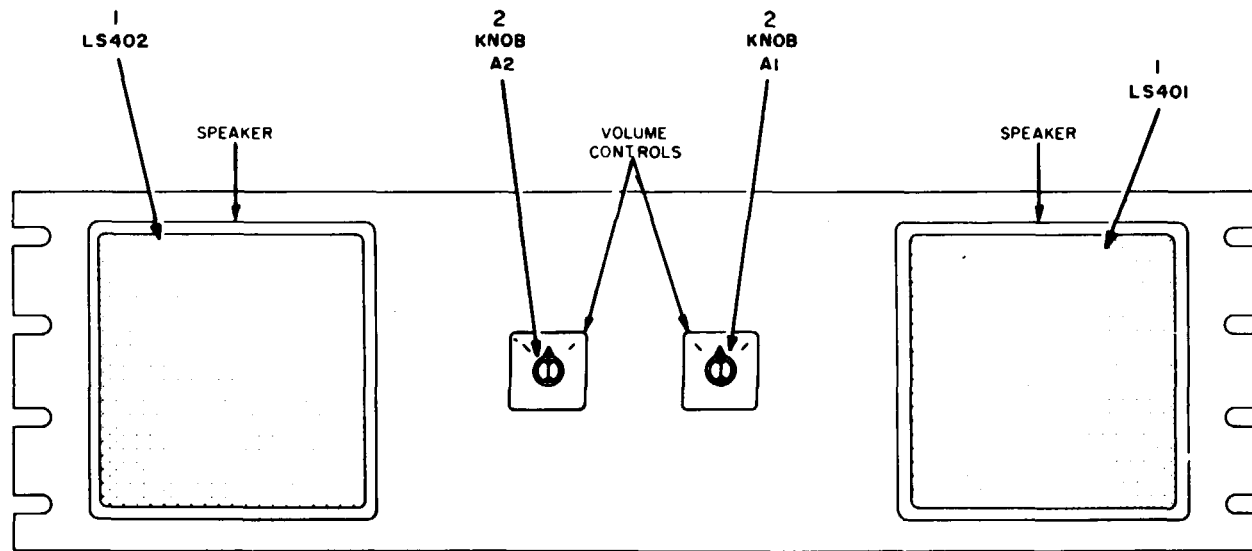

Figure 47. Patch Panel

SECTION II. REPAIR PARTS LIST



EL 5895-288-24P-TM-48 (1)

Figure 48. Dual Speaker and Amplifier Panel, Type 414A (Sheet 1 of 2)

SECTION II. REPAIR PARTS LIST

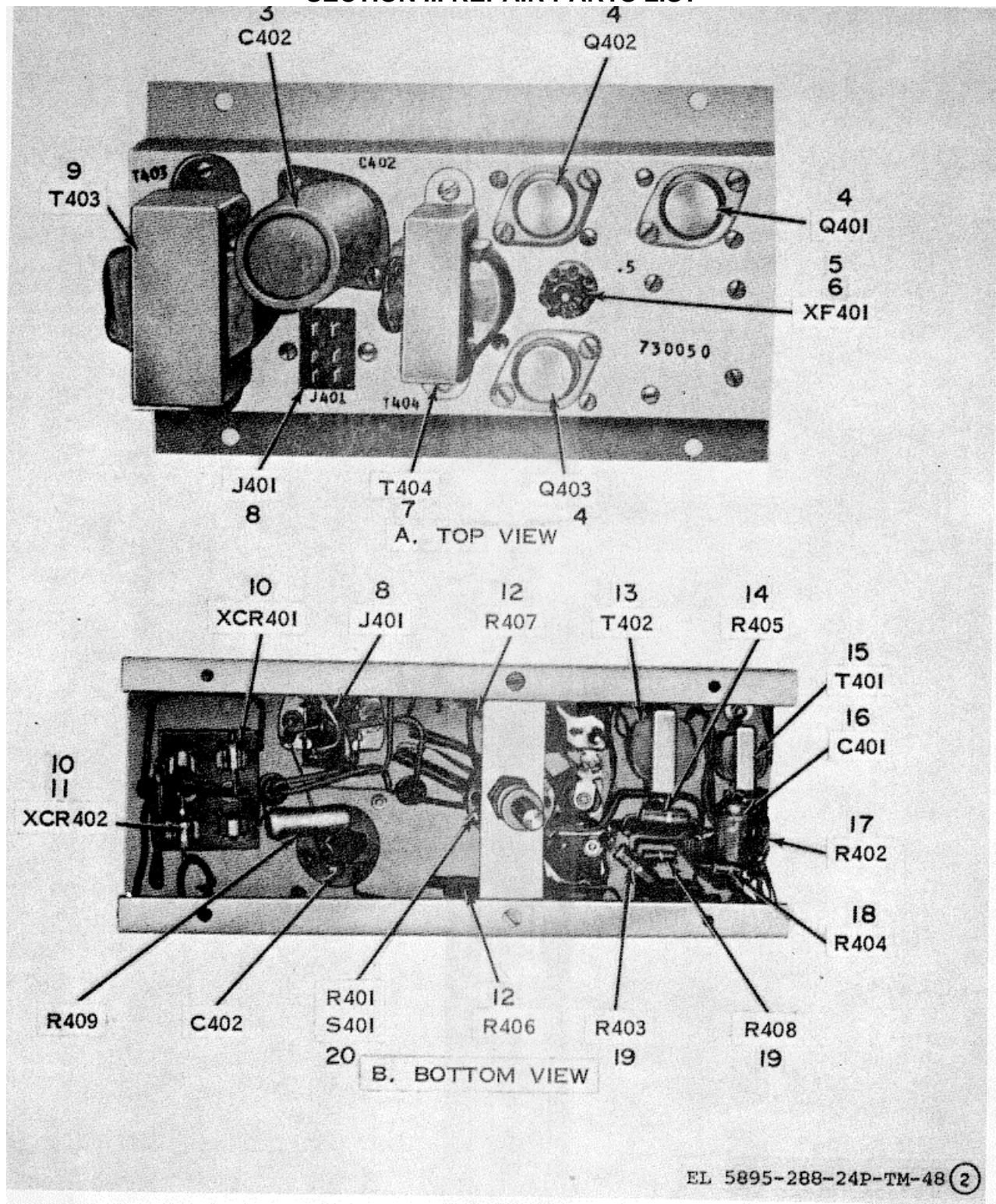

EL 5895-288-24P-TM-48 (2)

Figure 48. Dual Speaker and Amplifier Panel, Type 414A (Sheet 2 of 2)

SECTION II. REPAIR PARTS LIST

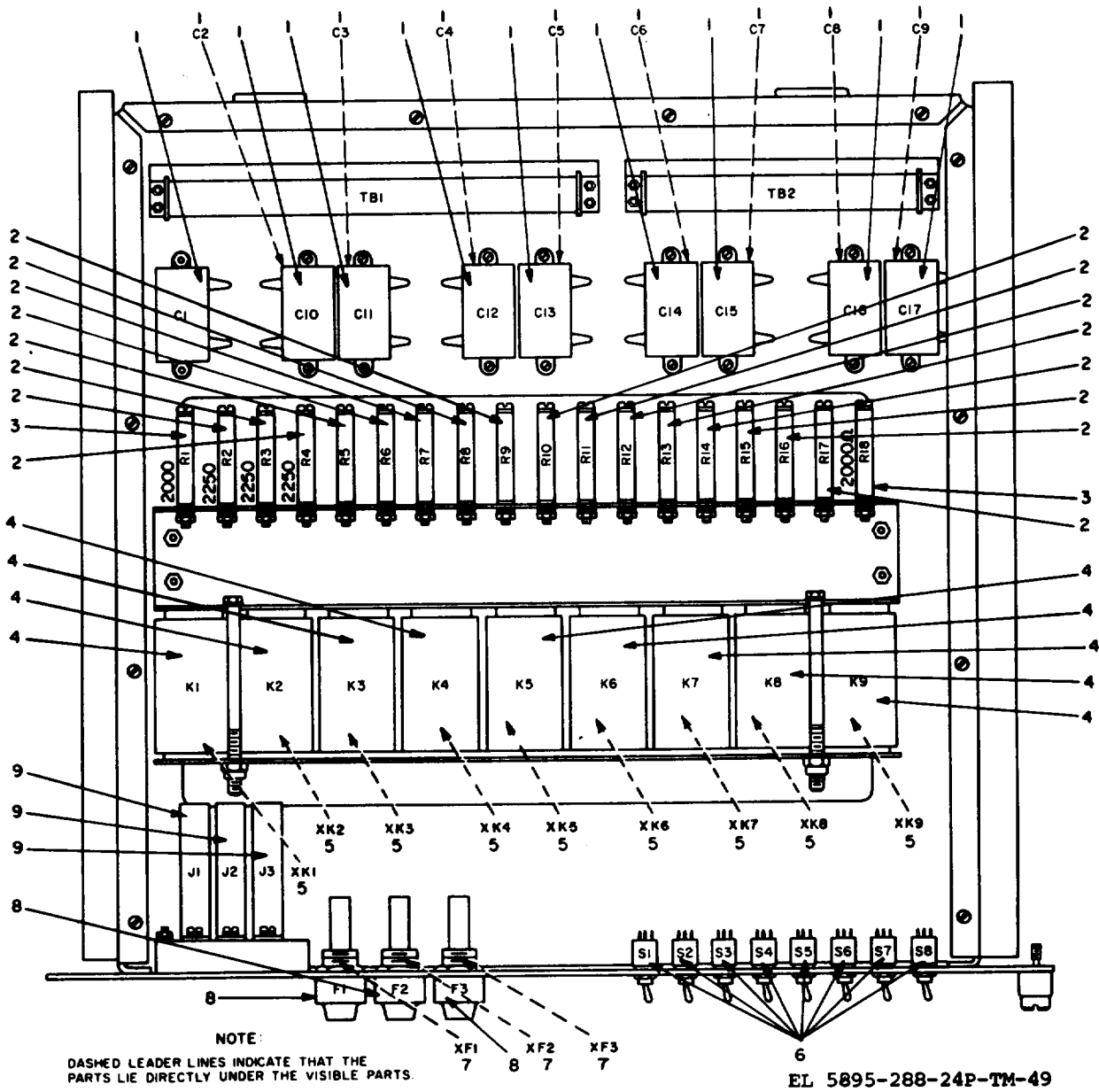

Figure 49. Multiple Repeat Panel

SECTION II. REPAIR PARTS LIST

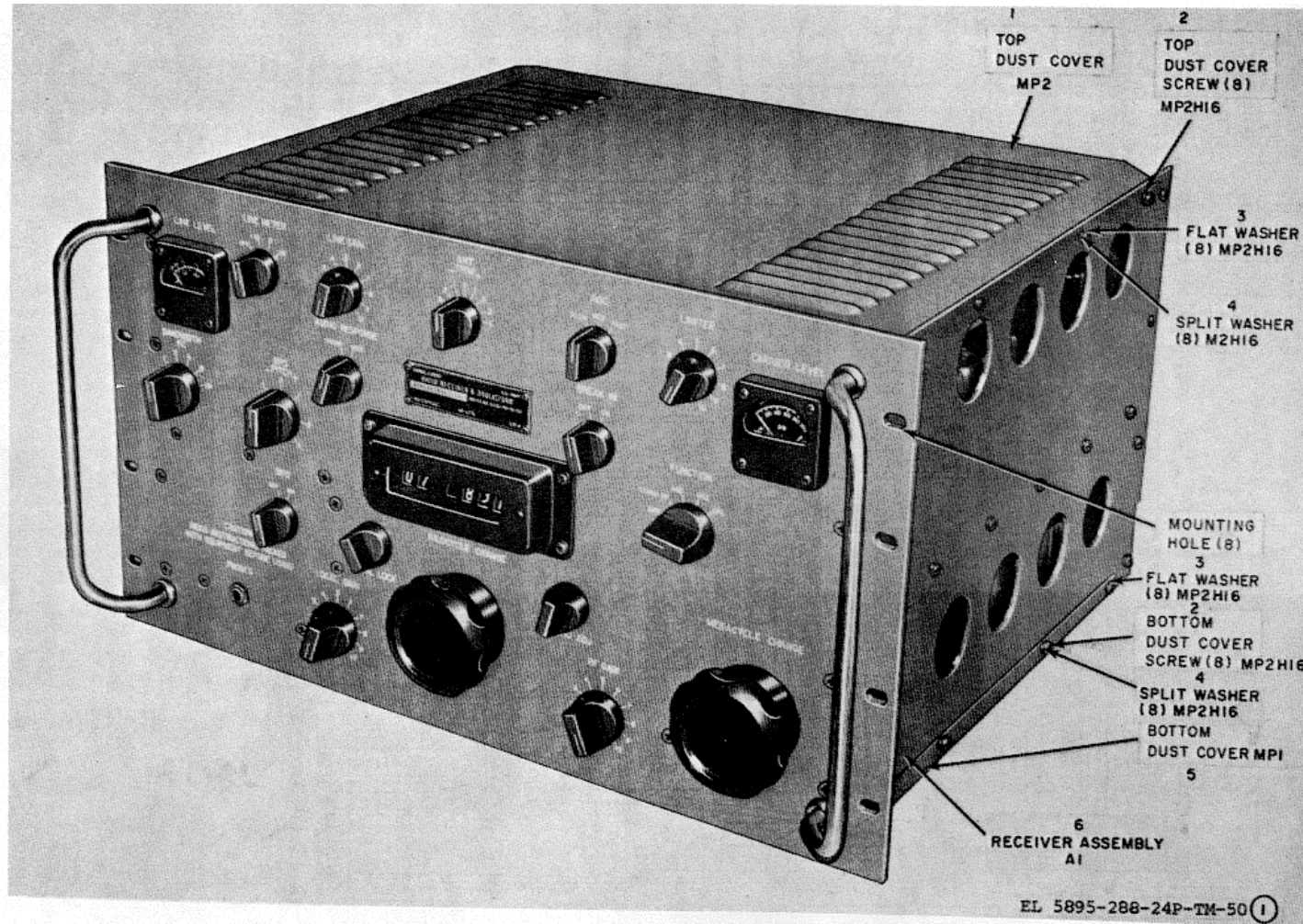

Figure 50. Radio Receiver P-1981/TSC-25 (Sheet 1 of 3)

SECTION II. REPAIR PARTS LIST

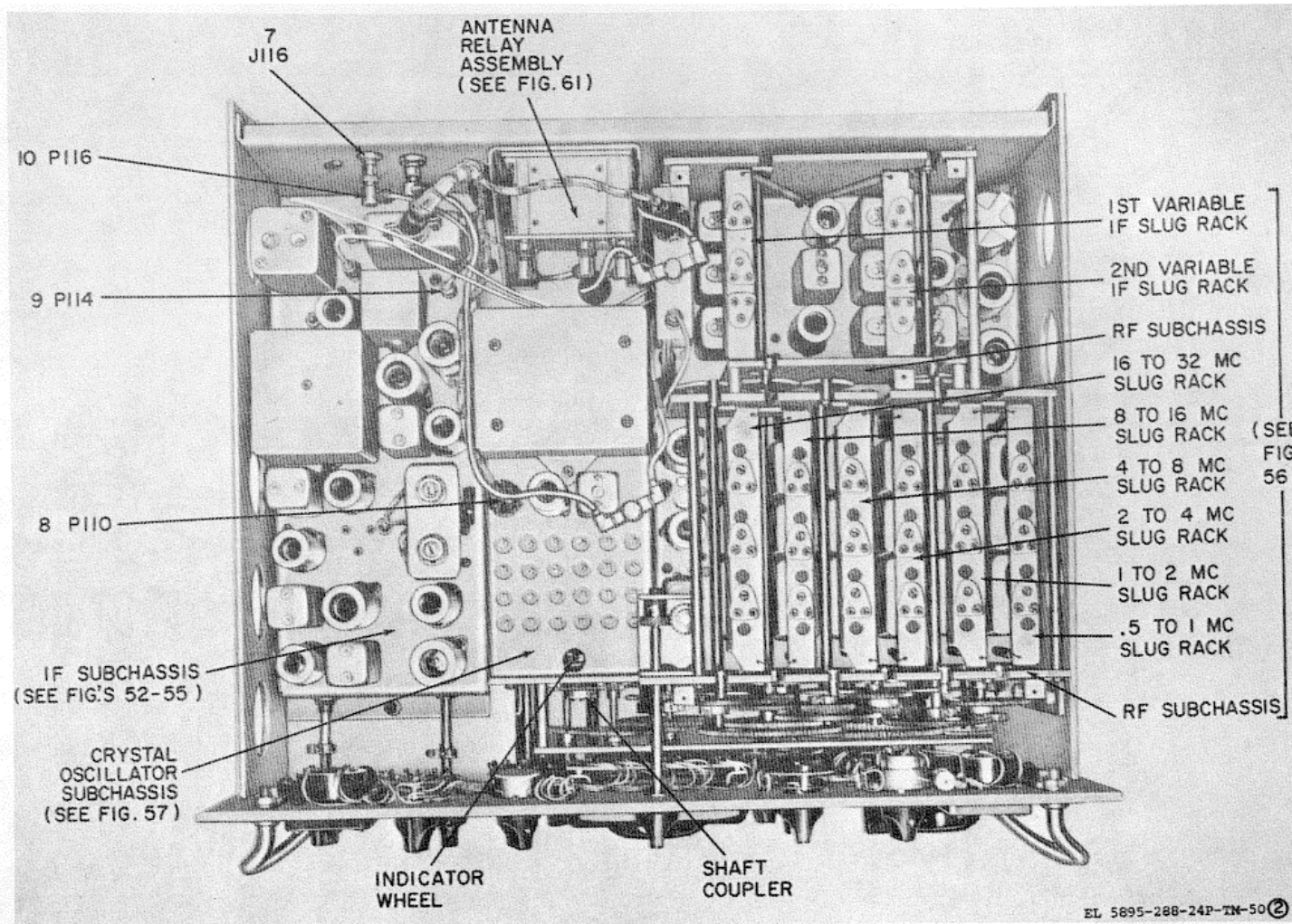

Figure 50. Radio Receiver R-1981/TSC-25 (Sheet 2 of 3)

SECTION II. REPAIR PARTS LIST

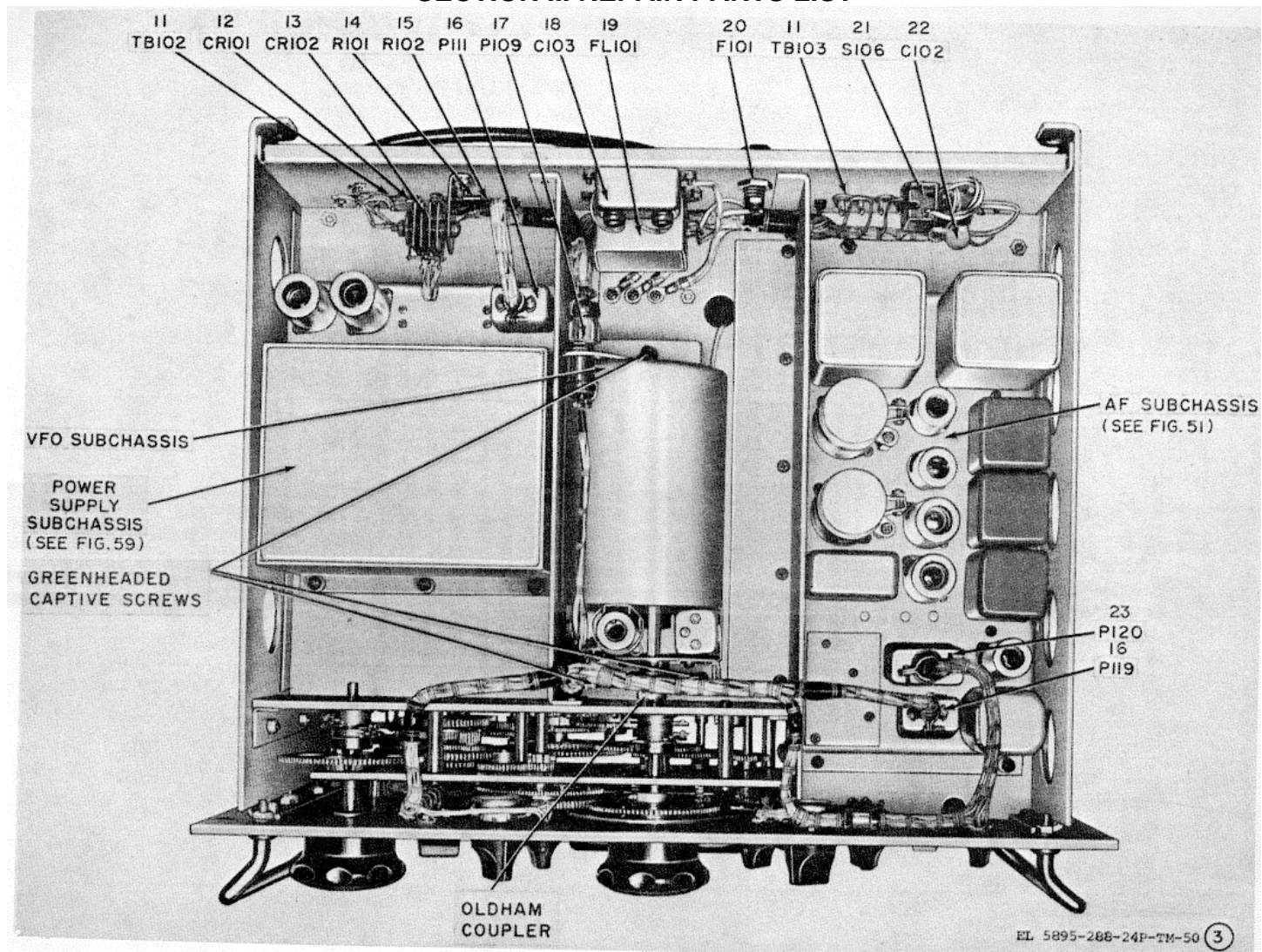

Figure 50. Radio Receiver R-1981/TSC-25 (Sheet 3 of 3)

SECTION II. REPAIR PARTS LIST

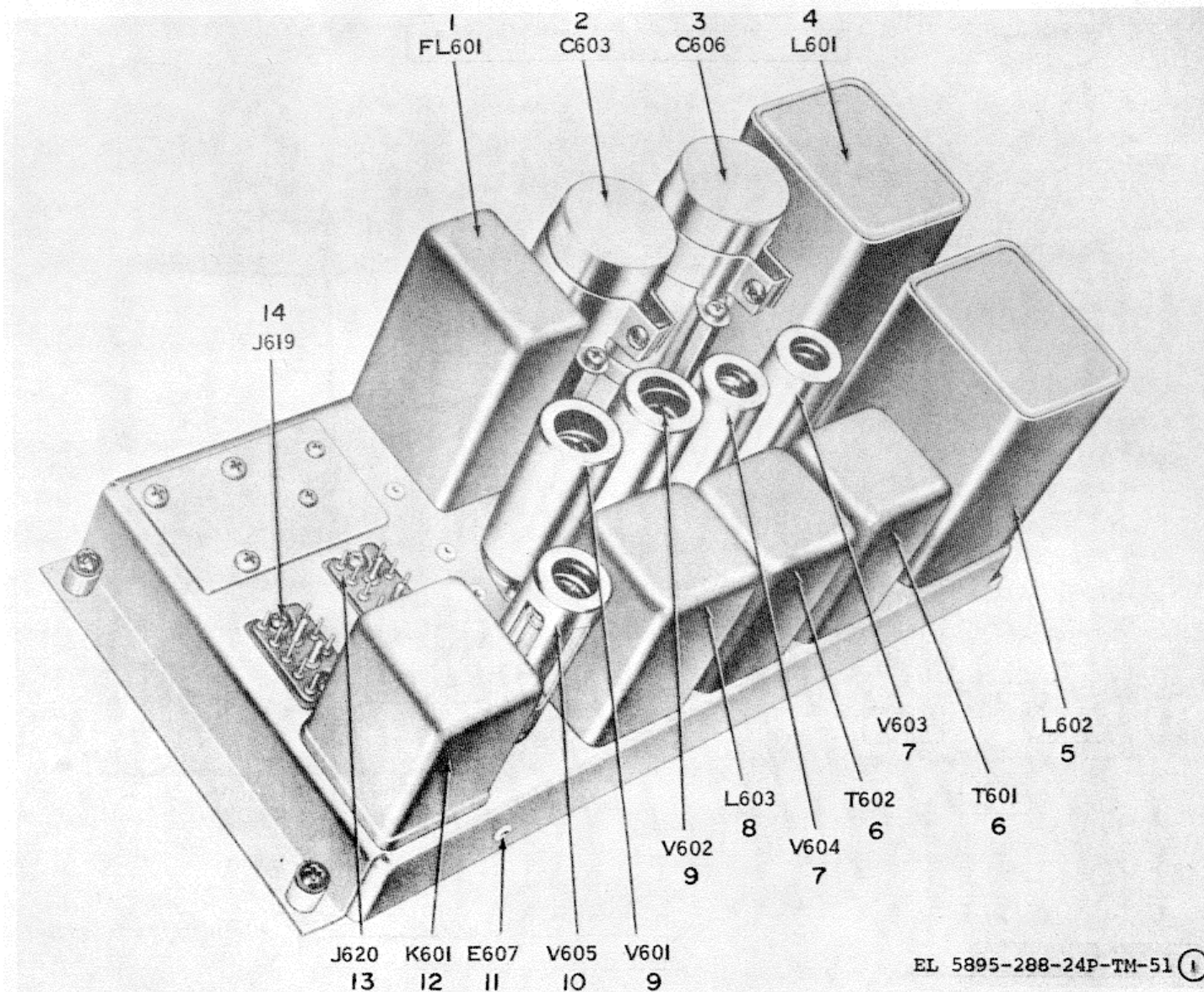

Figure 51. Audio Assembly A1A2 (Sheet 1 of 2)

SECTION II. REPAIR PARTS LIST

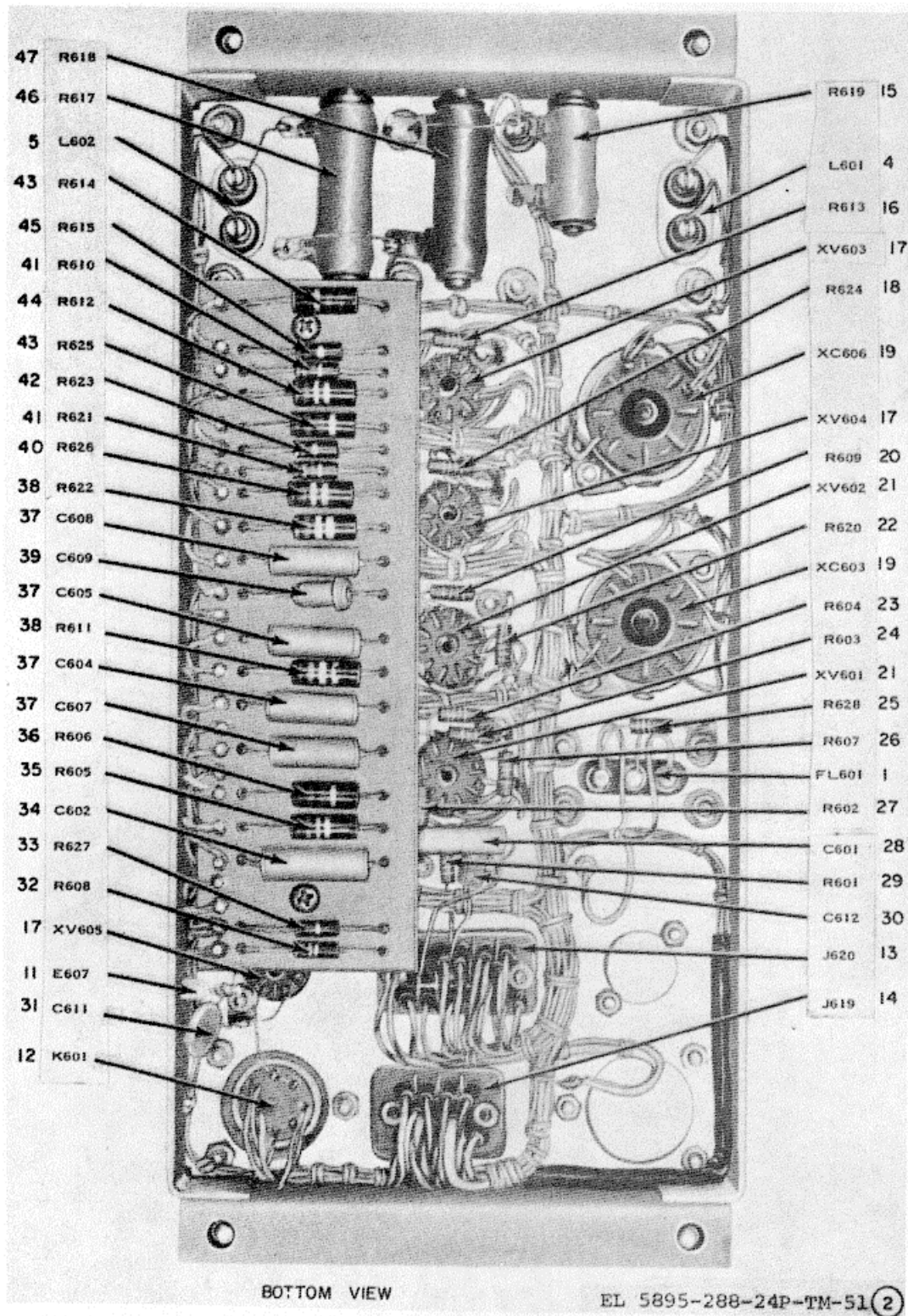

Figure 51. Audio Assembly A1A2 (Sheet 2 of 2)

SECTION II. REPAIR PARTS LIST

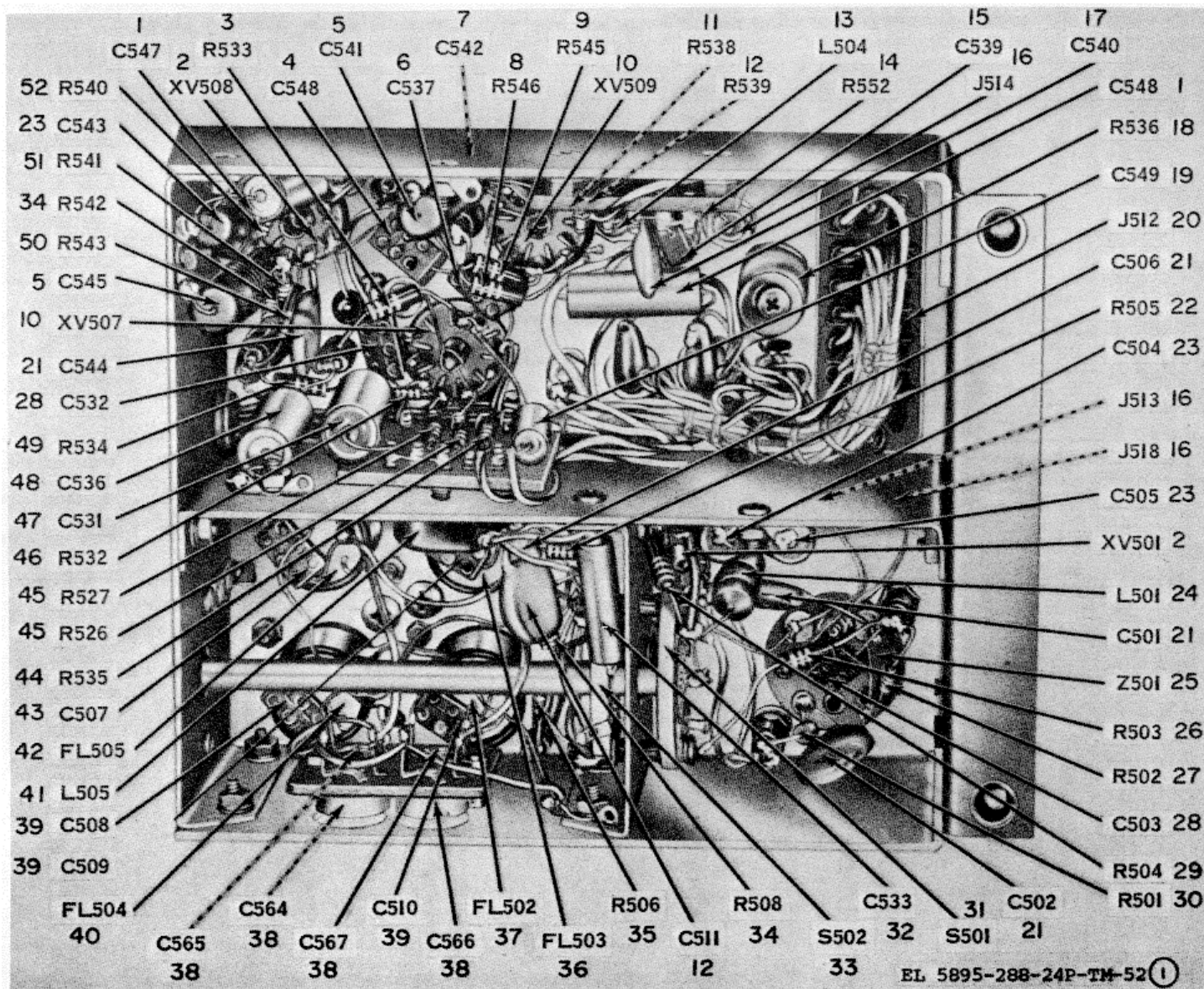

Figure 52. Amplifier subassembly, Bottom view Front Section (Sheet 1 of 2)

SECTION II. REPAIR PARTS LIST

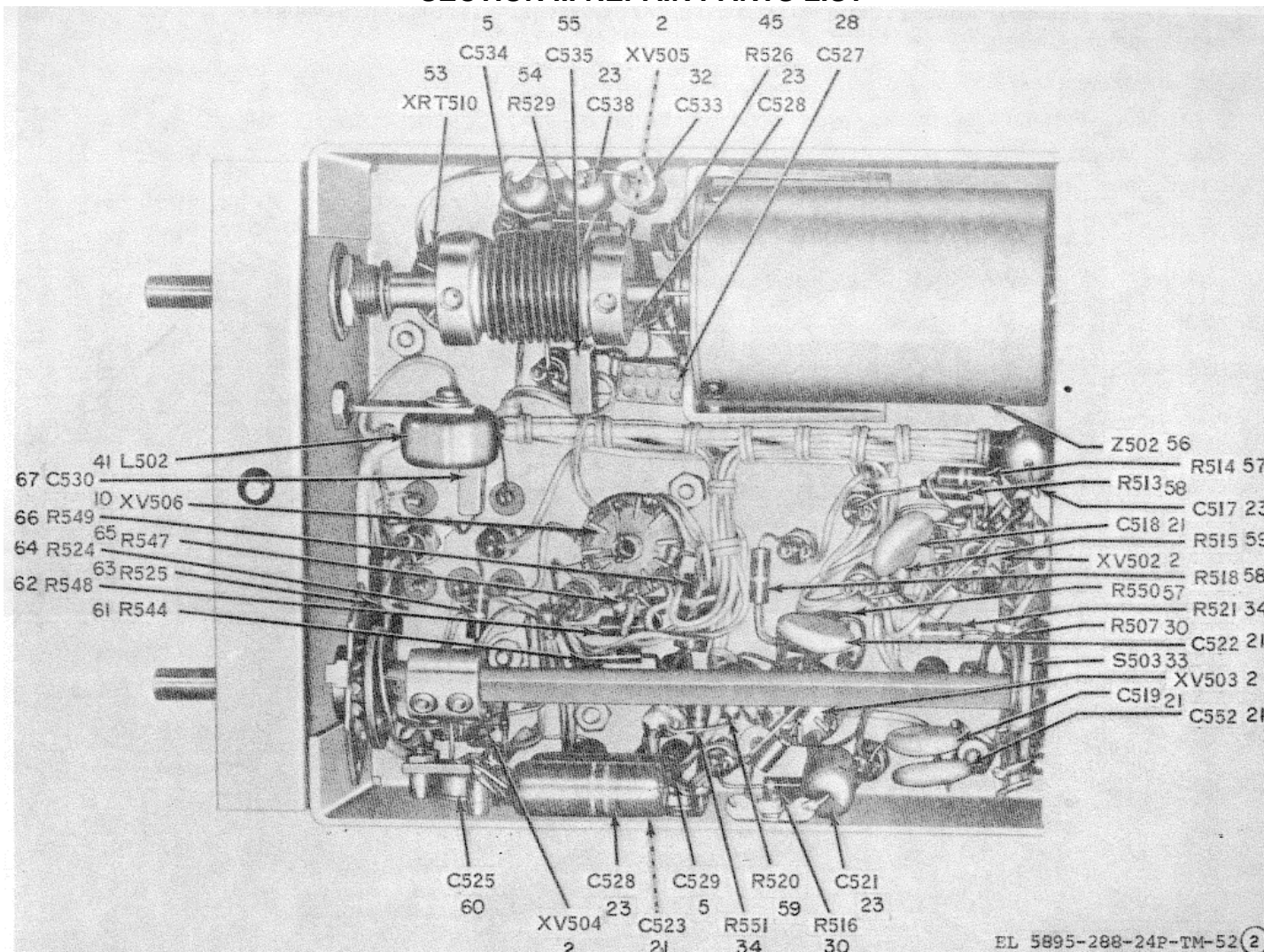

Figure 52. Amplifier Subassembly, Bottom View Front Section (Sheet 2 of 2)

SECTION II. REPAIR PARTS LIST

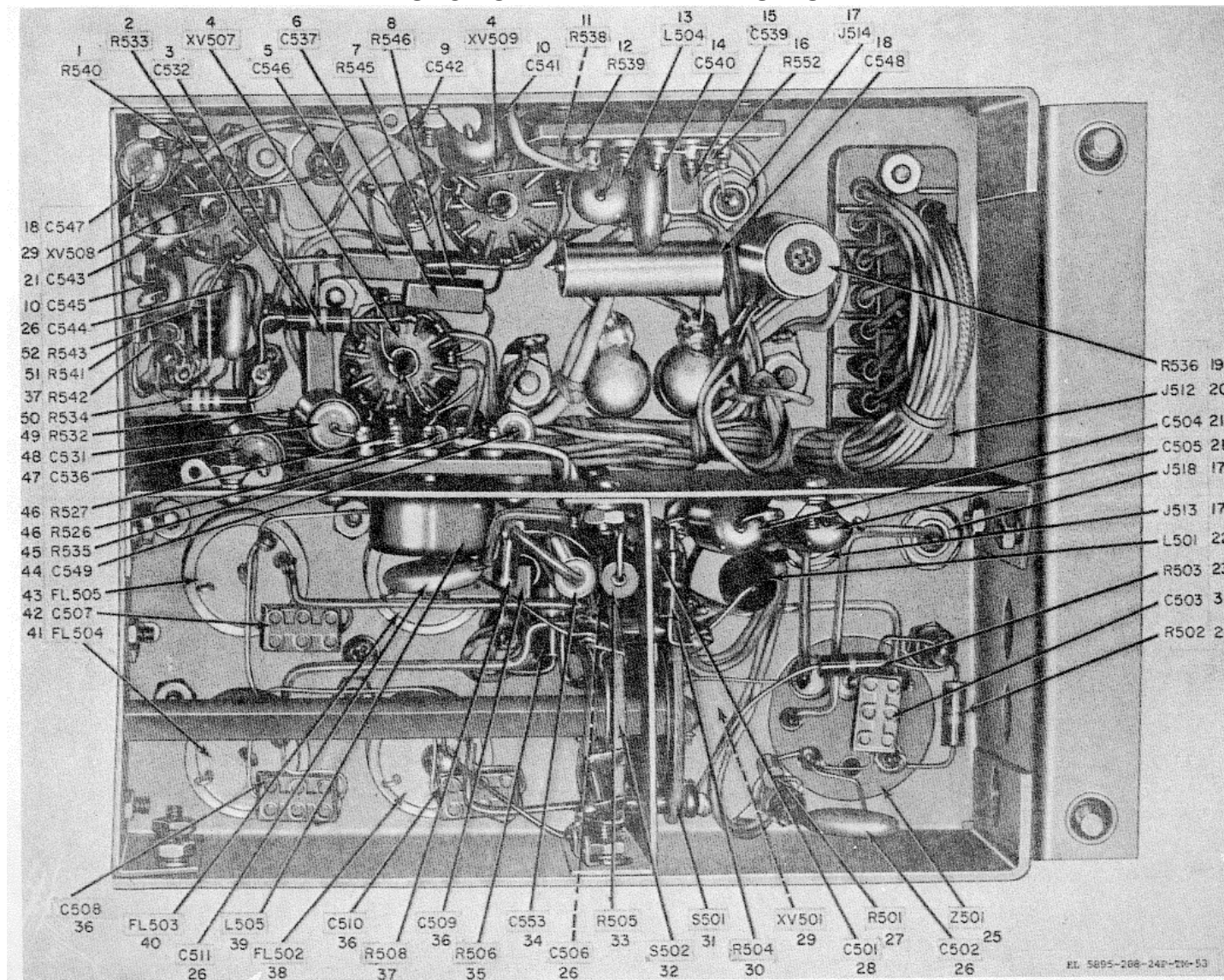

Figure 53. Unmodified IF Subchassis, Bottom View, Rear Section

SECTION II. REPAIR PARTS LIST

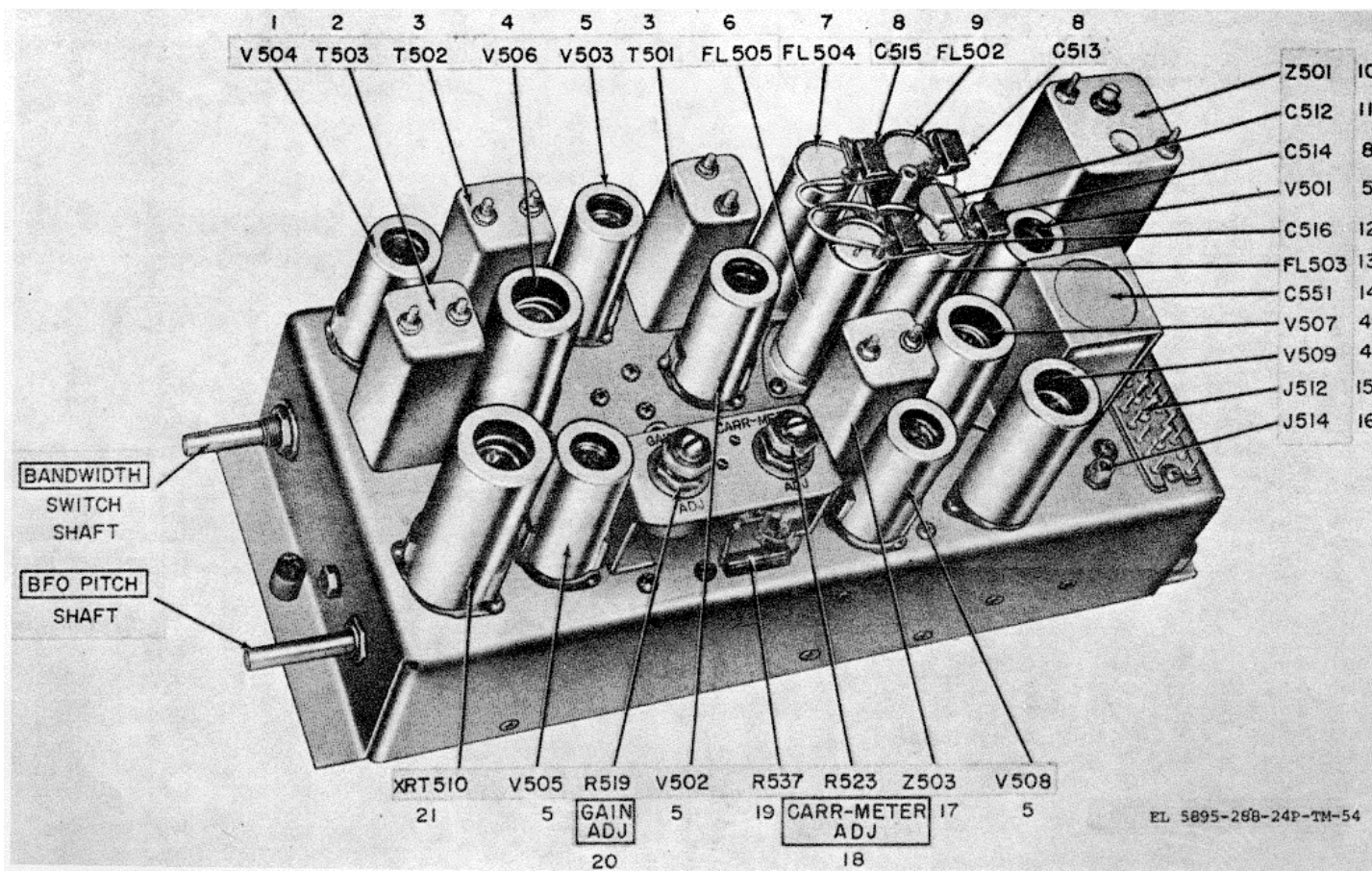

Figure 54. Unmodified IF Subchassis, Top View

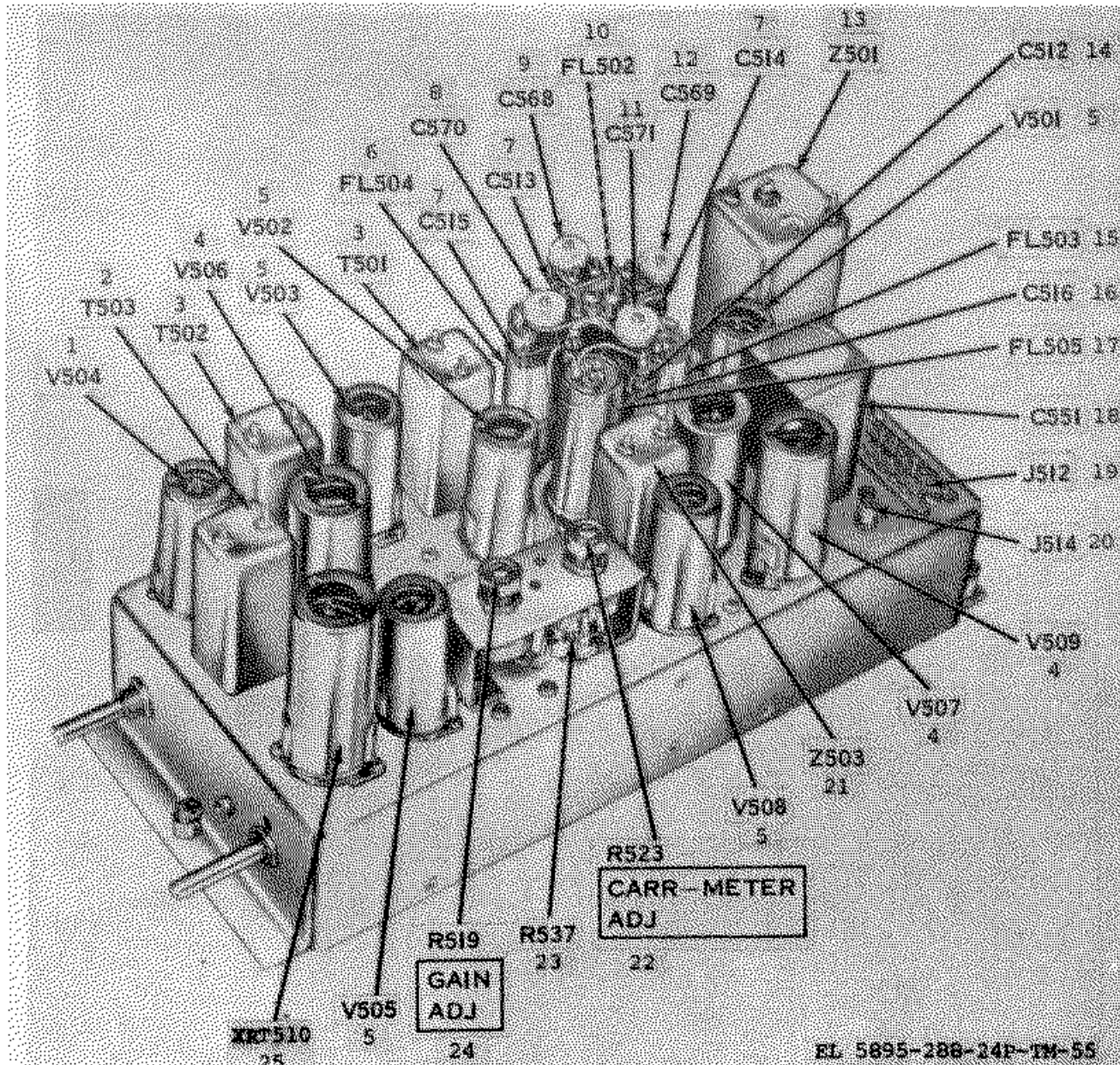

Figure 55. IF Subchassis, Mod 1, Order No. 363- Phila-54 and All IF Subchassis on Order No. 14-Phila-56, Top View

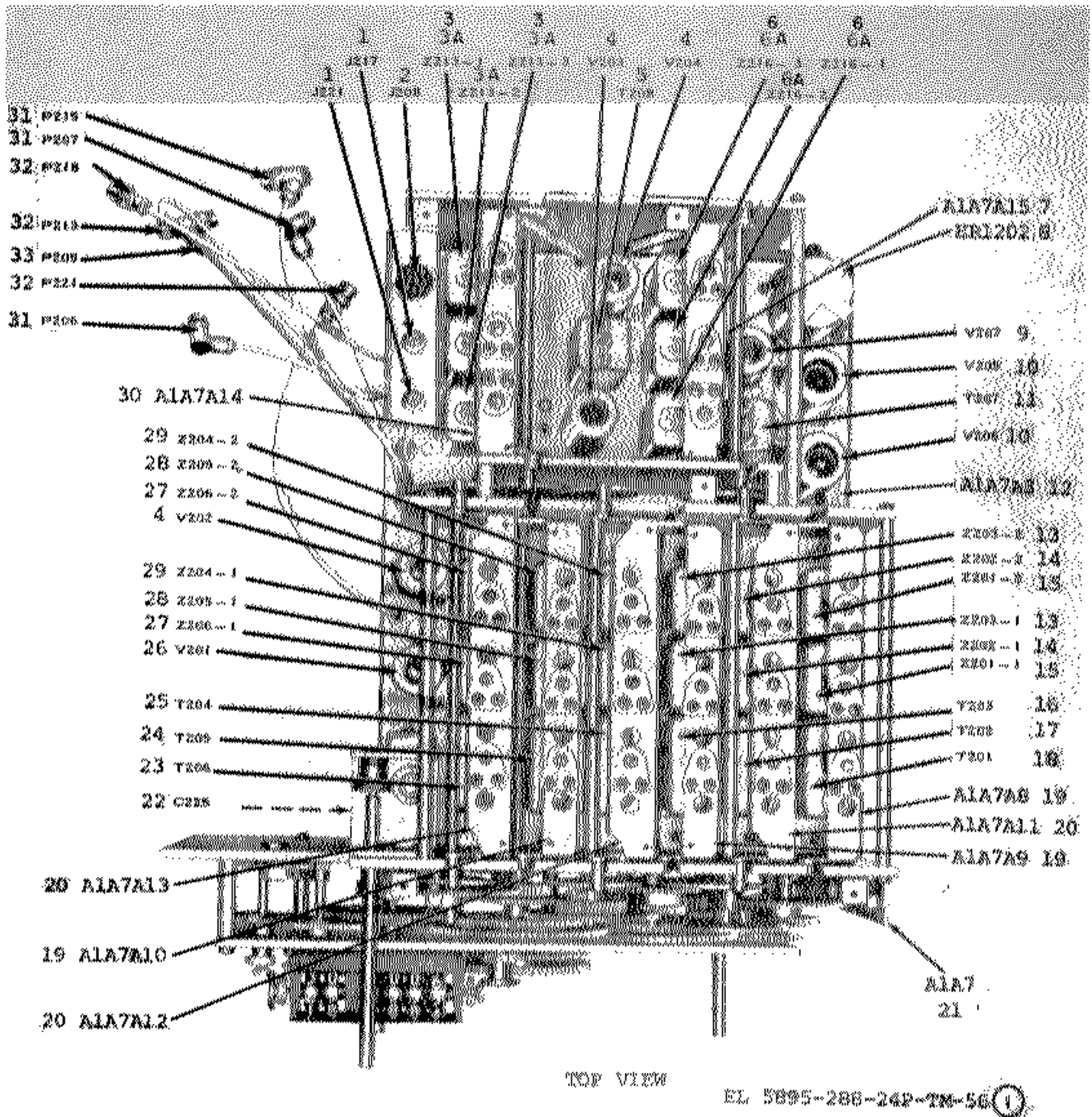

Figure 56. Radio Frequency Amplifier A1A7 (Sheet 1 of 3)

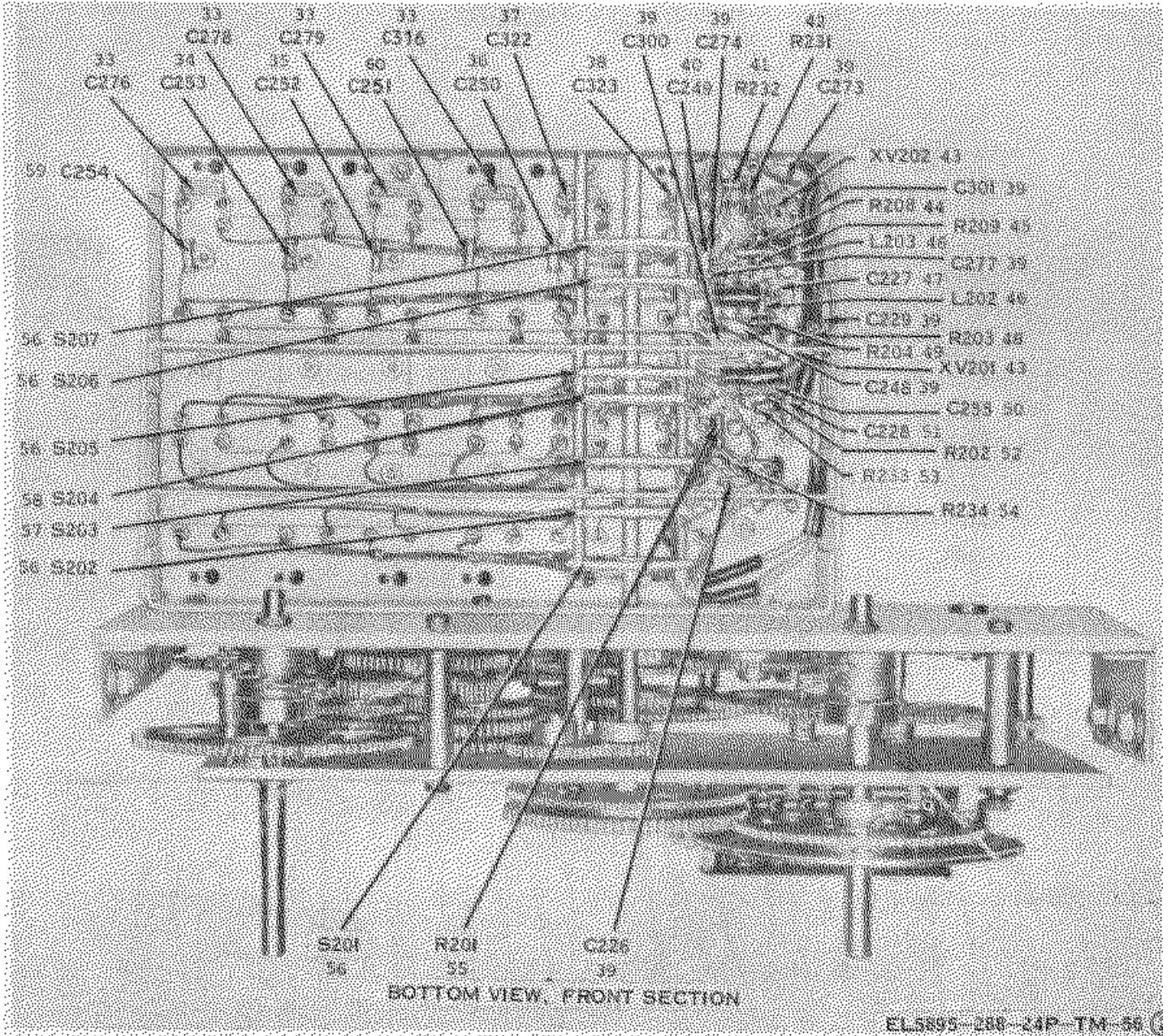

Figure 56. Radio Frequency Amplifier A1A7 (Sheet 2 of 3)

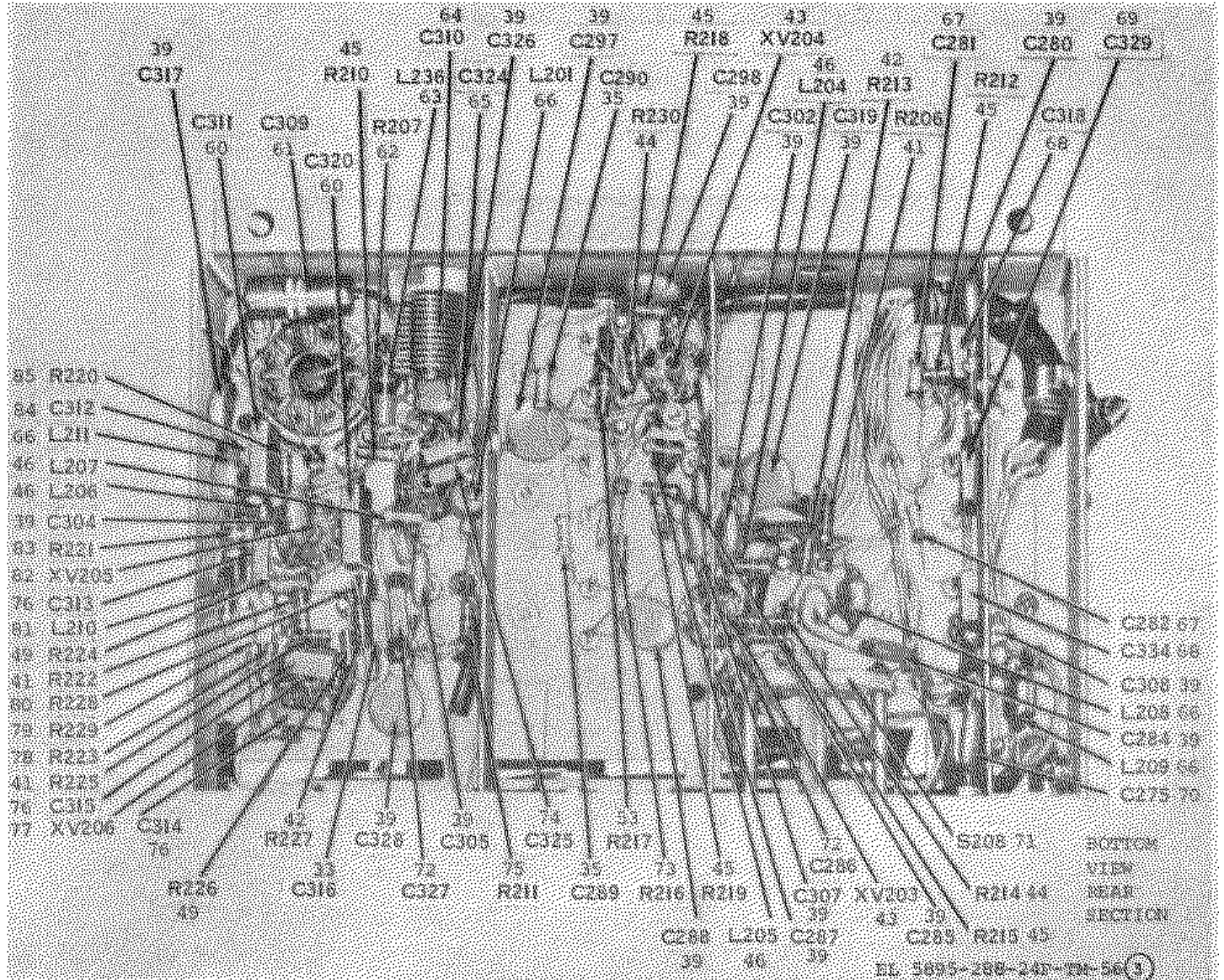

Figure 56. Radio Frequency Amplifier A1A7 (Sheet 3 of 3)

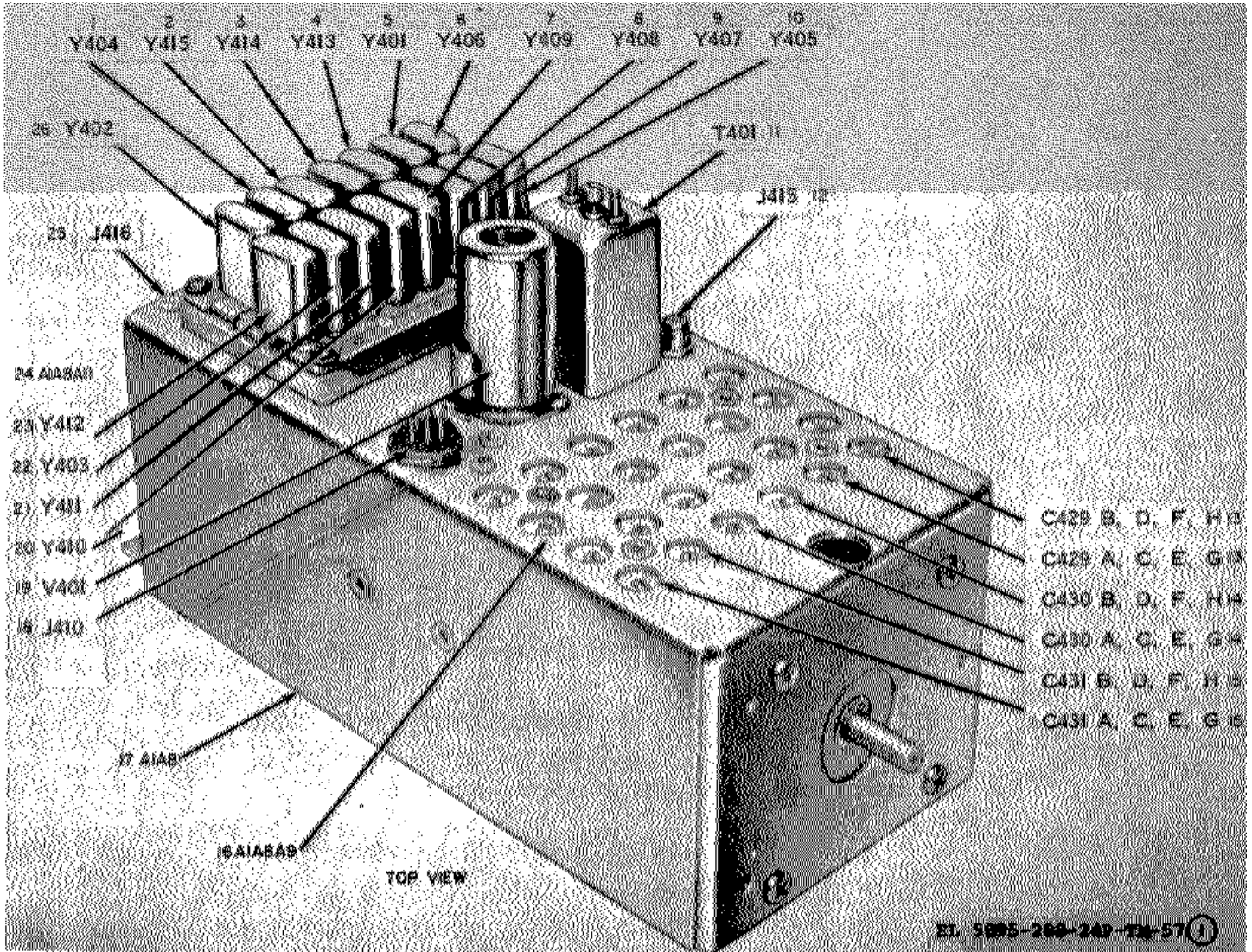

Figure 57. Crystal Oscillator Subchassis A1A8 (Sheet 1 of 3)

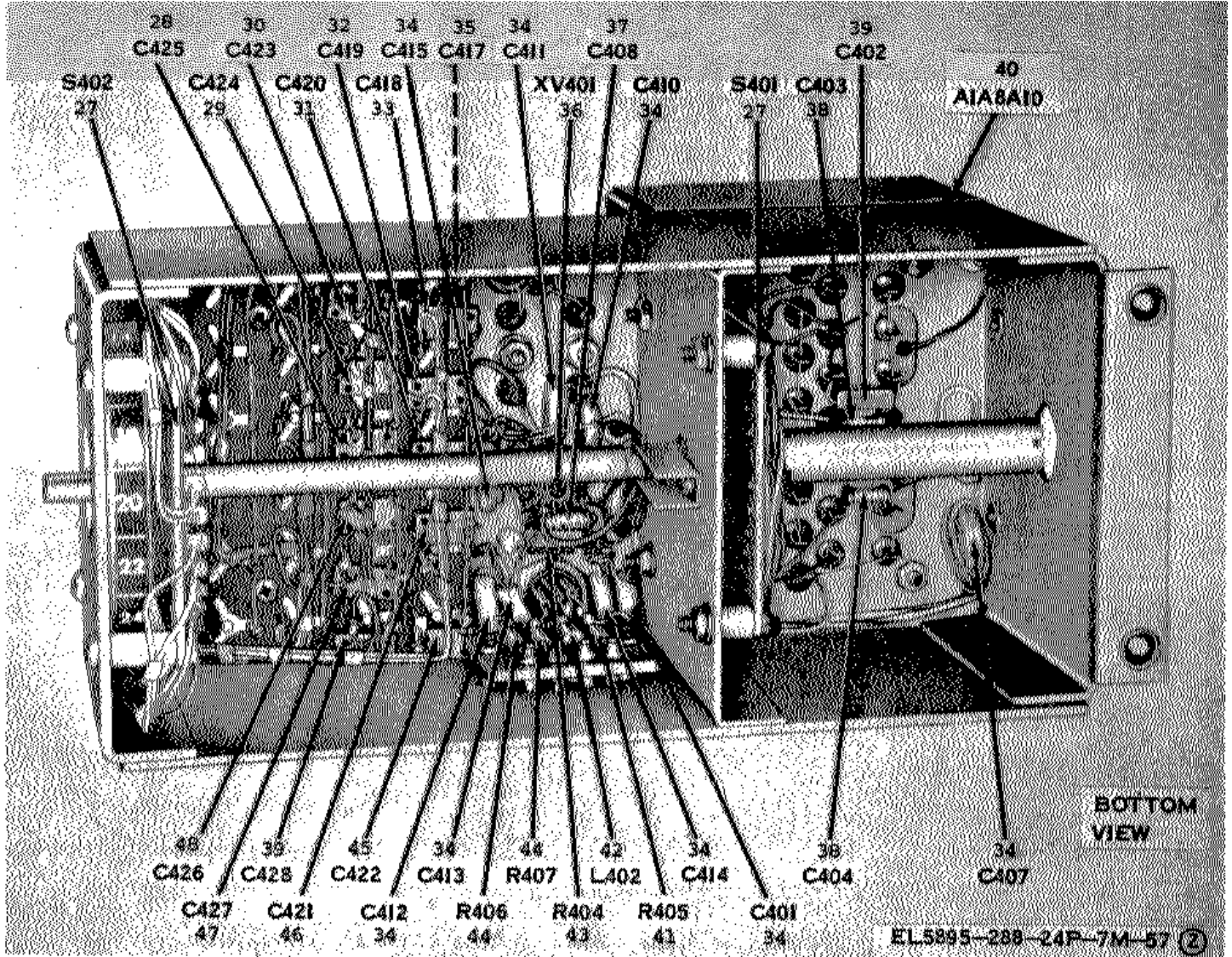

Figure 57. Crystal Oscillator Subchassis A1A8 (Sheet 2 of 3)

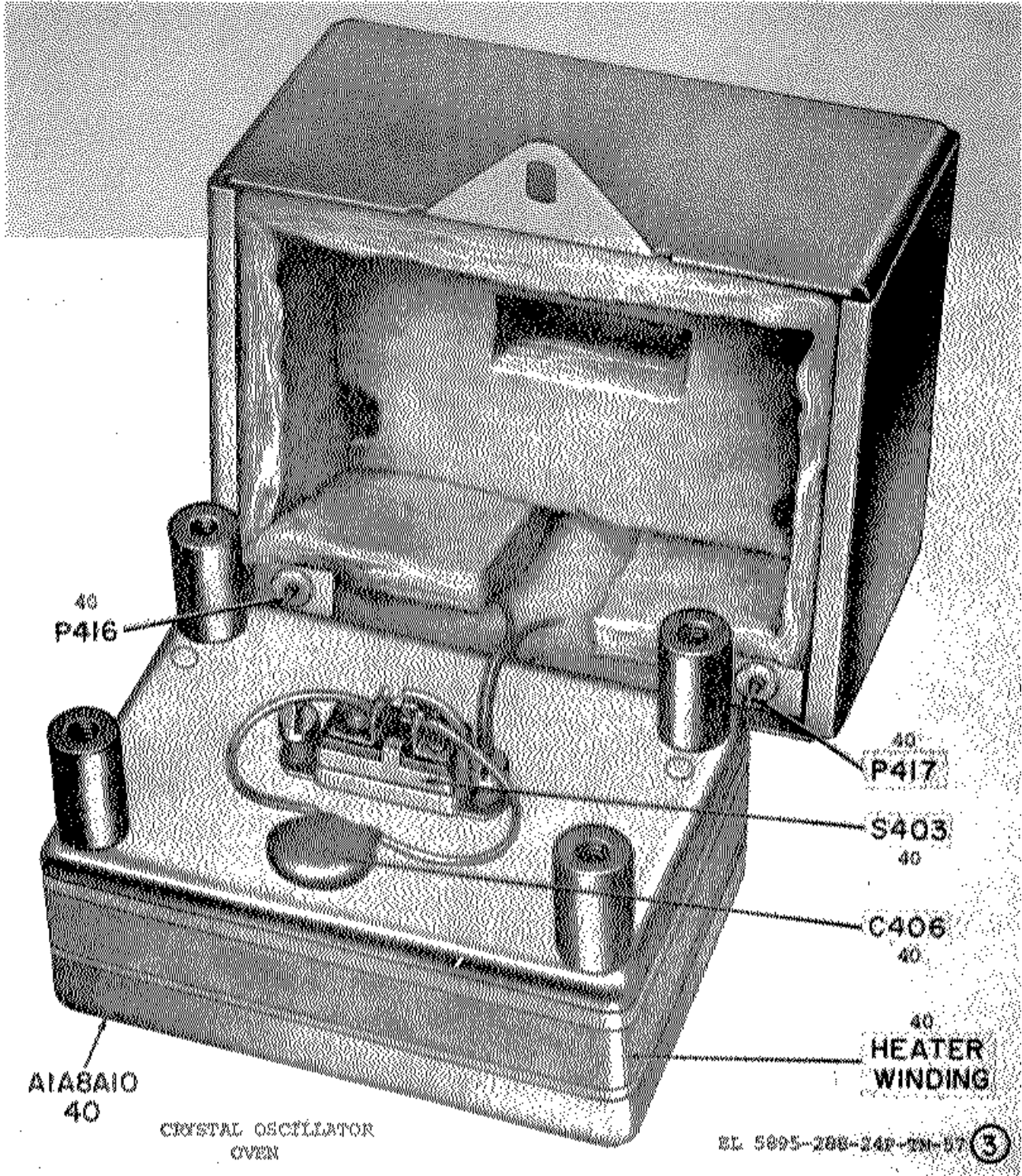

Figure 57. Crystal Oscillator Subchassis A1A8 (Sheet 3 of 3)

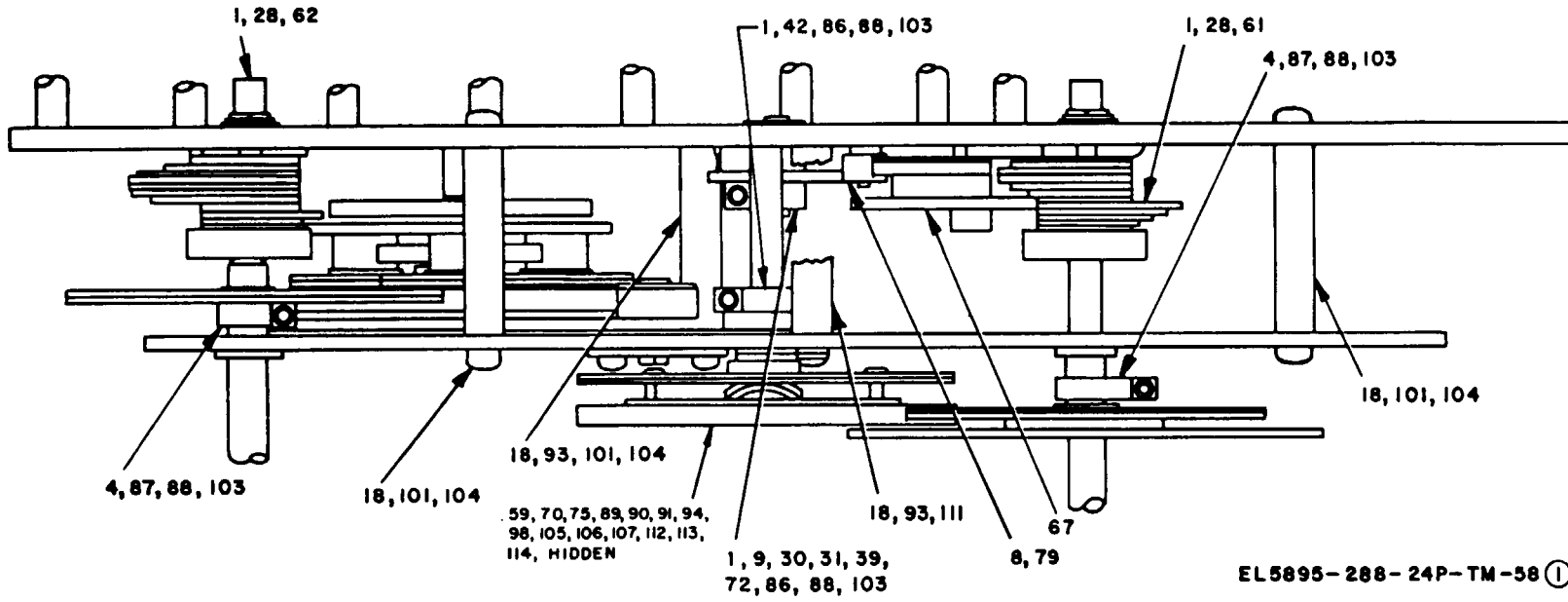
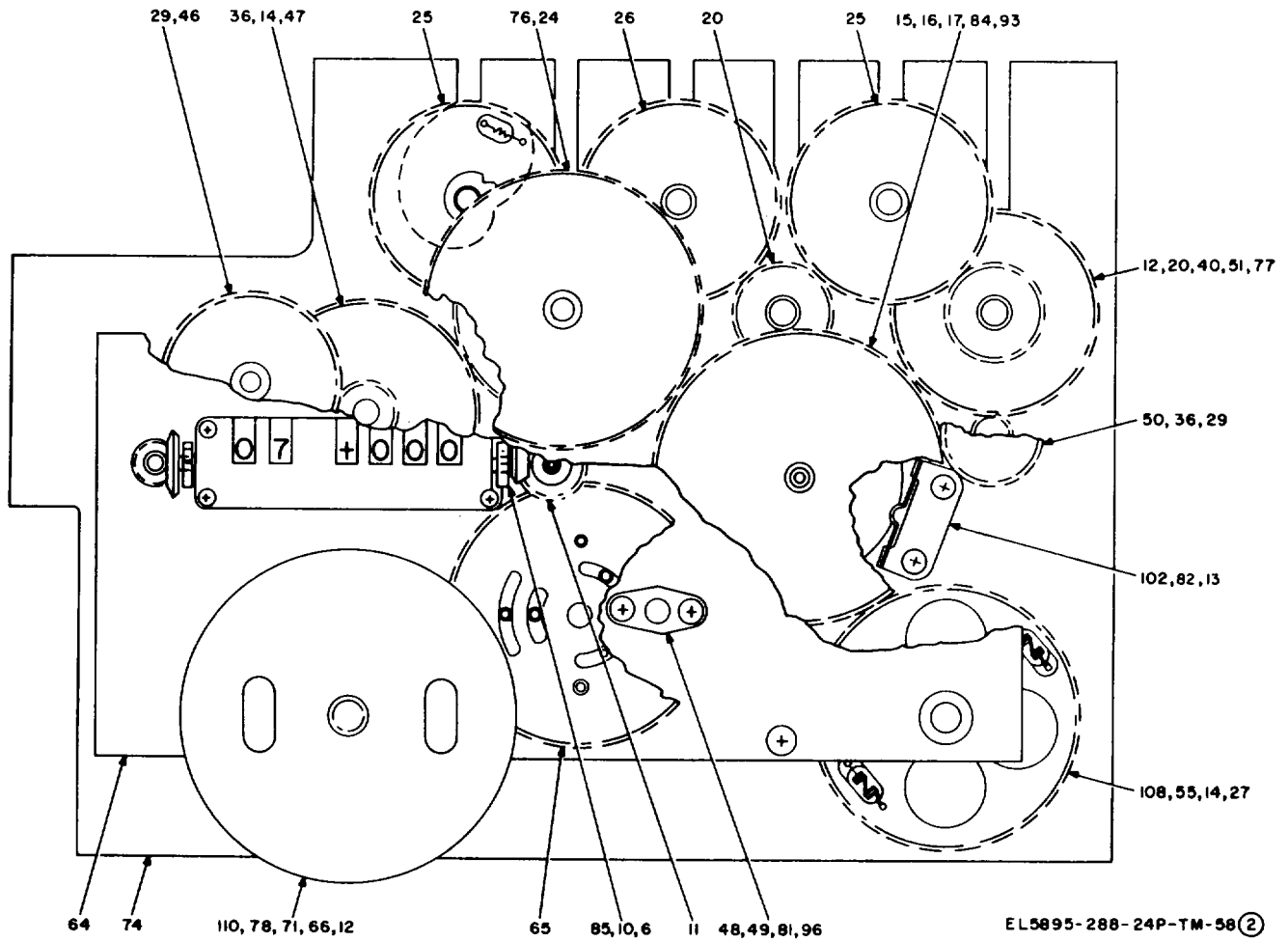
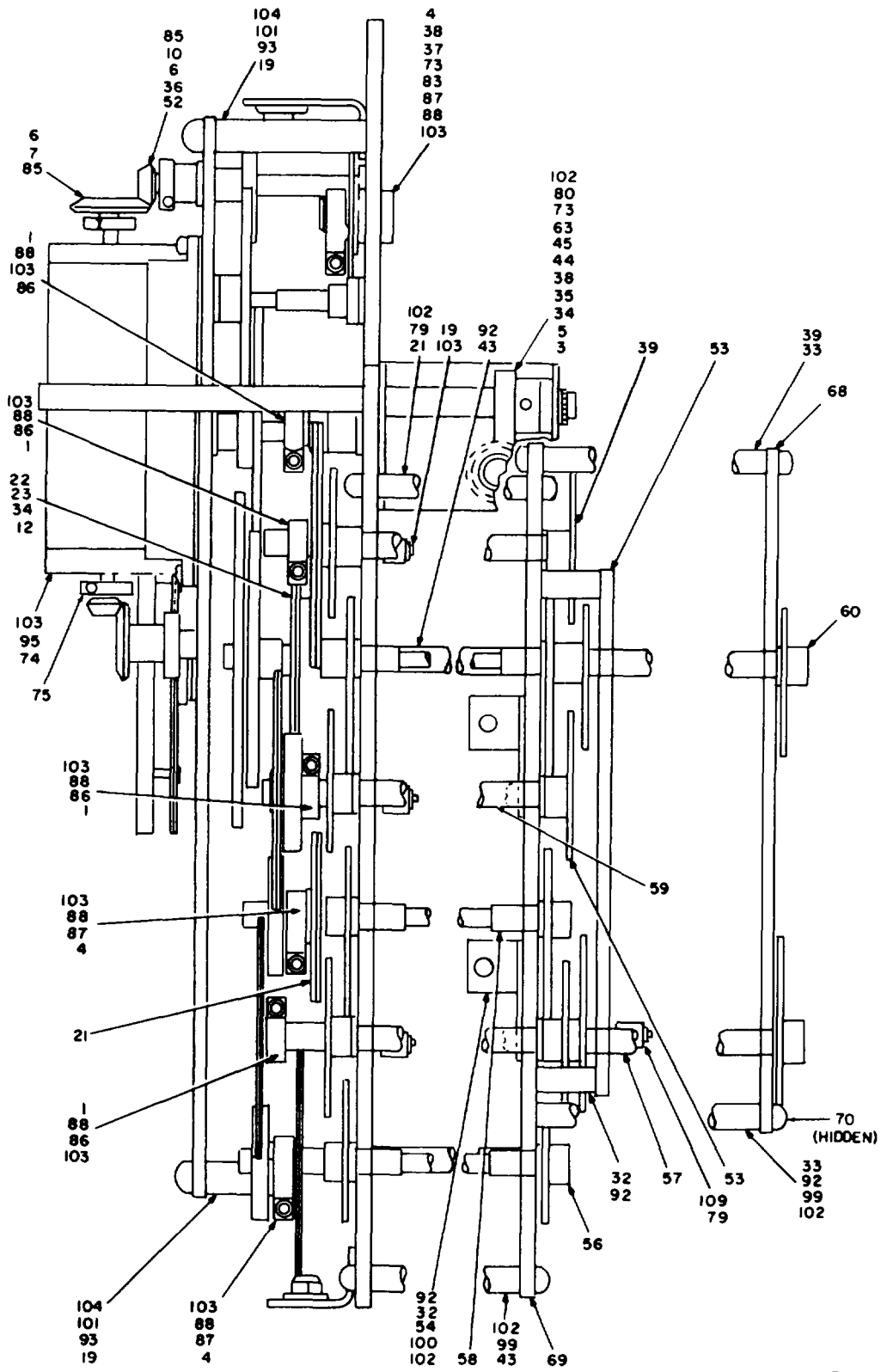

Figure 58. Gear Train Assembly A1A9 (Sheet 1 of 6)



EL5895-288-24P-TM-58 (2)

Figure 58. Gear Train Assembly A1A9 (Sheet 2 of 6)



EL5895-288-24P-TM-58 (3)

Figure 58. Gear Train Assembly A1A9 (Sheet 3 of 6)

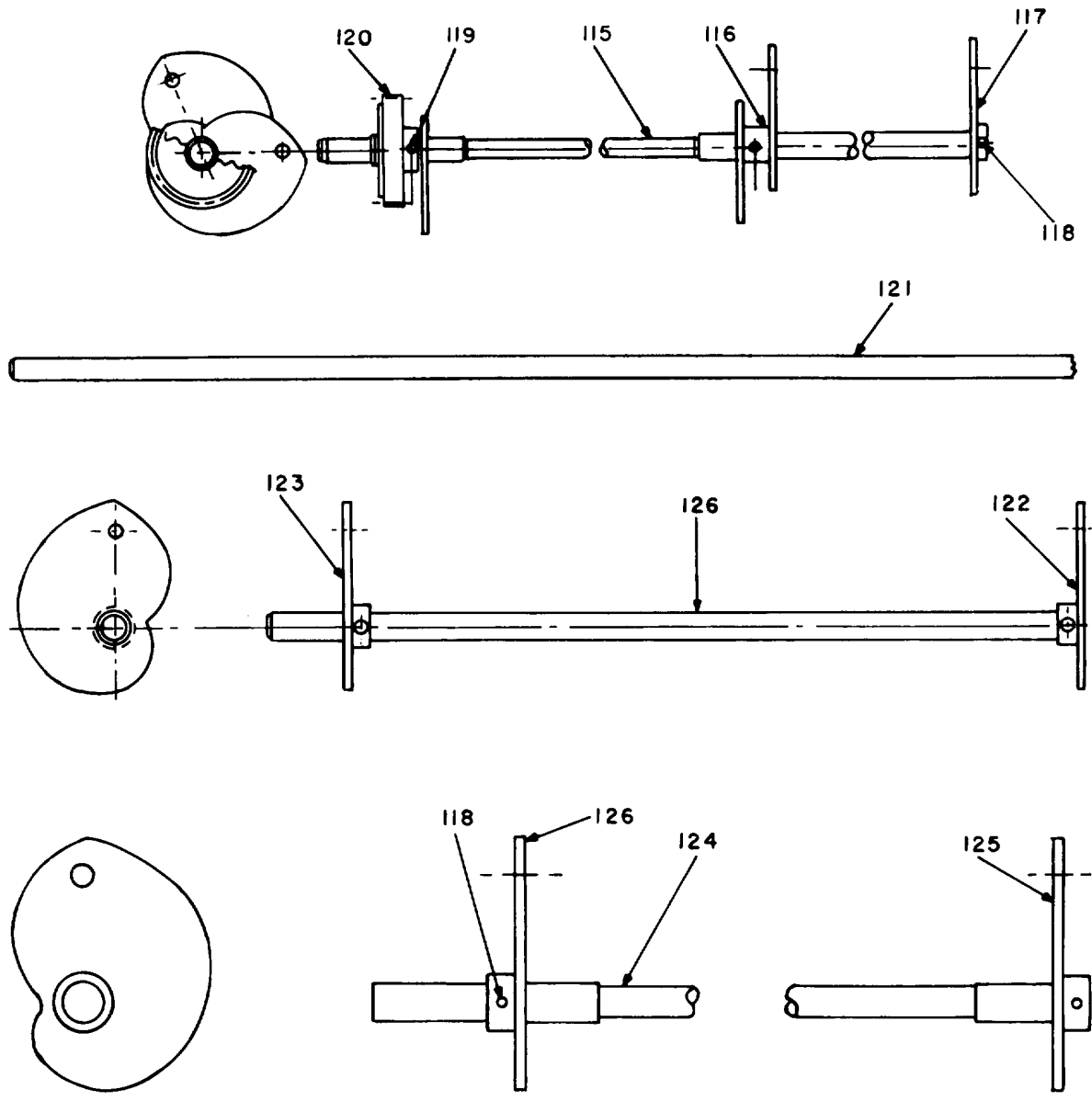

EL 5895-288-24P-TM-58 (4)

Figure 58. Gear Train Assembly A1A9 (Sheet 4 of 6)

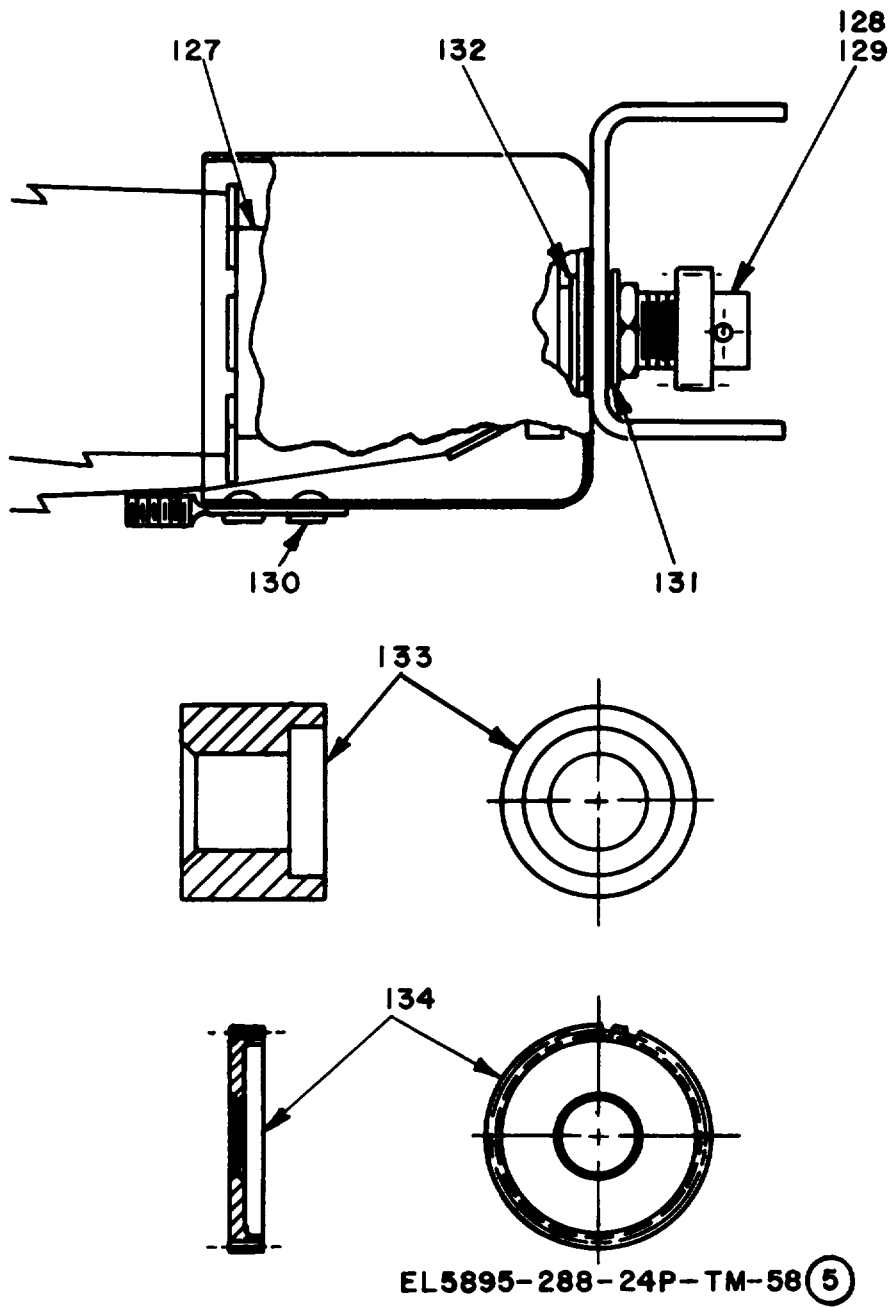
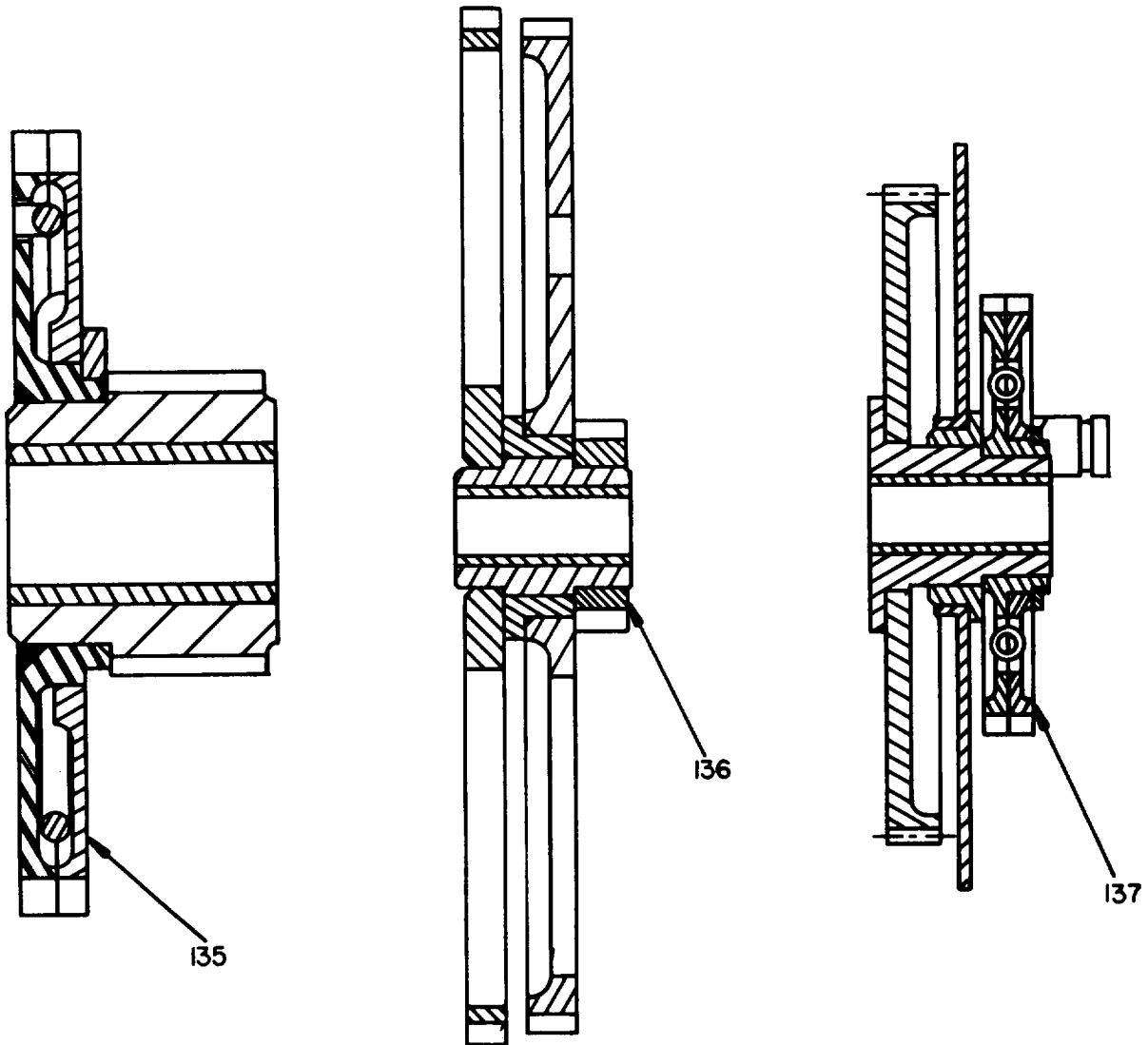

Figure 58. Gear Train Assembly A1A9 (Sheet 5 of 6)



EL5895-288-24P-TM-58 ⑥

Figure 58. Gear Train Assembly A1A9 (Sheet 6 of 6)

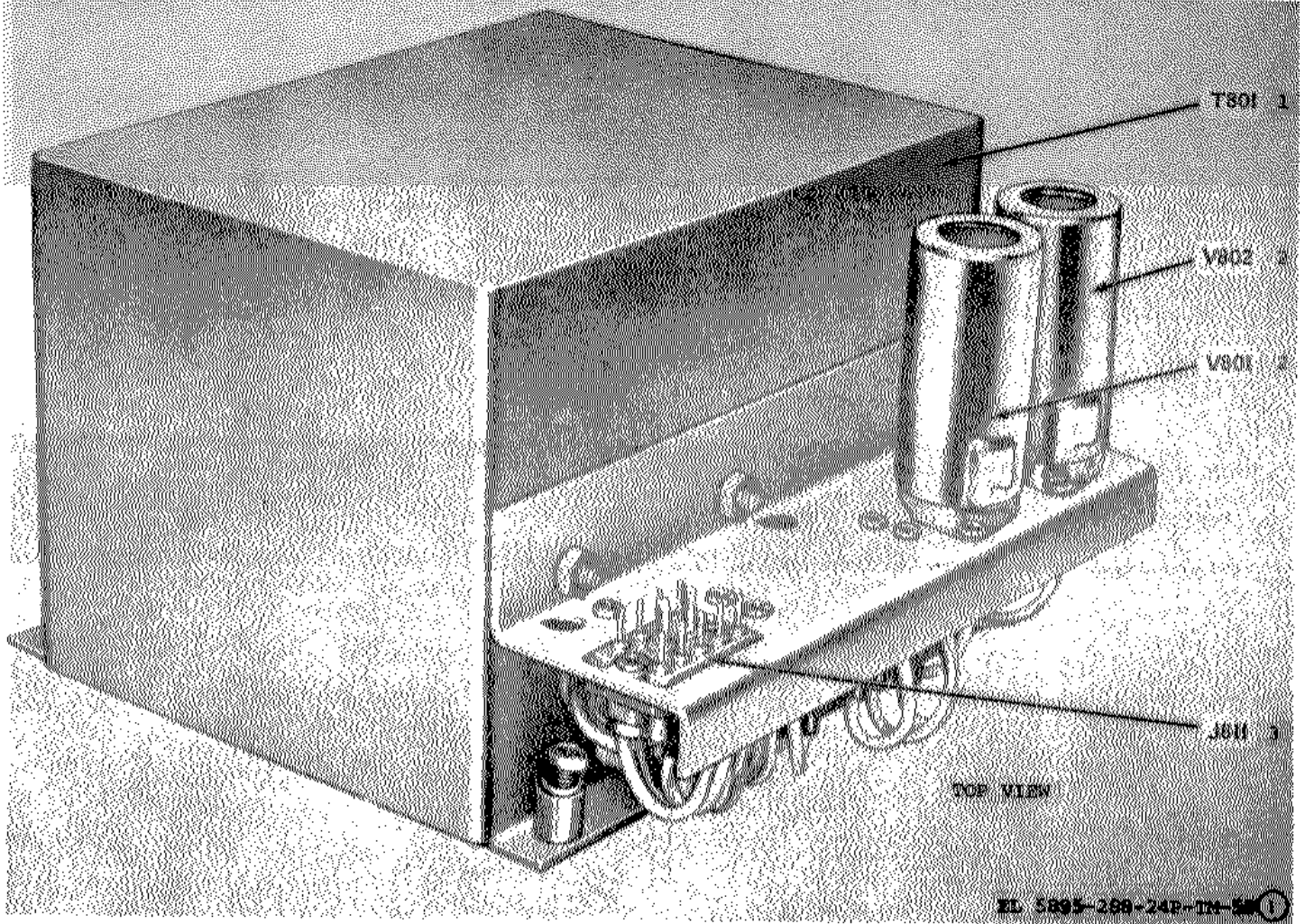

Figure 59. Power Supply Subchassis A1A5 (Sheet 1 of 2)

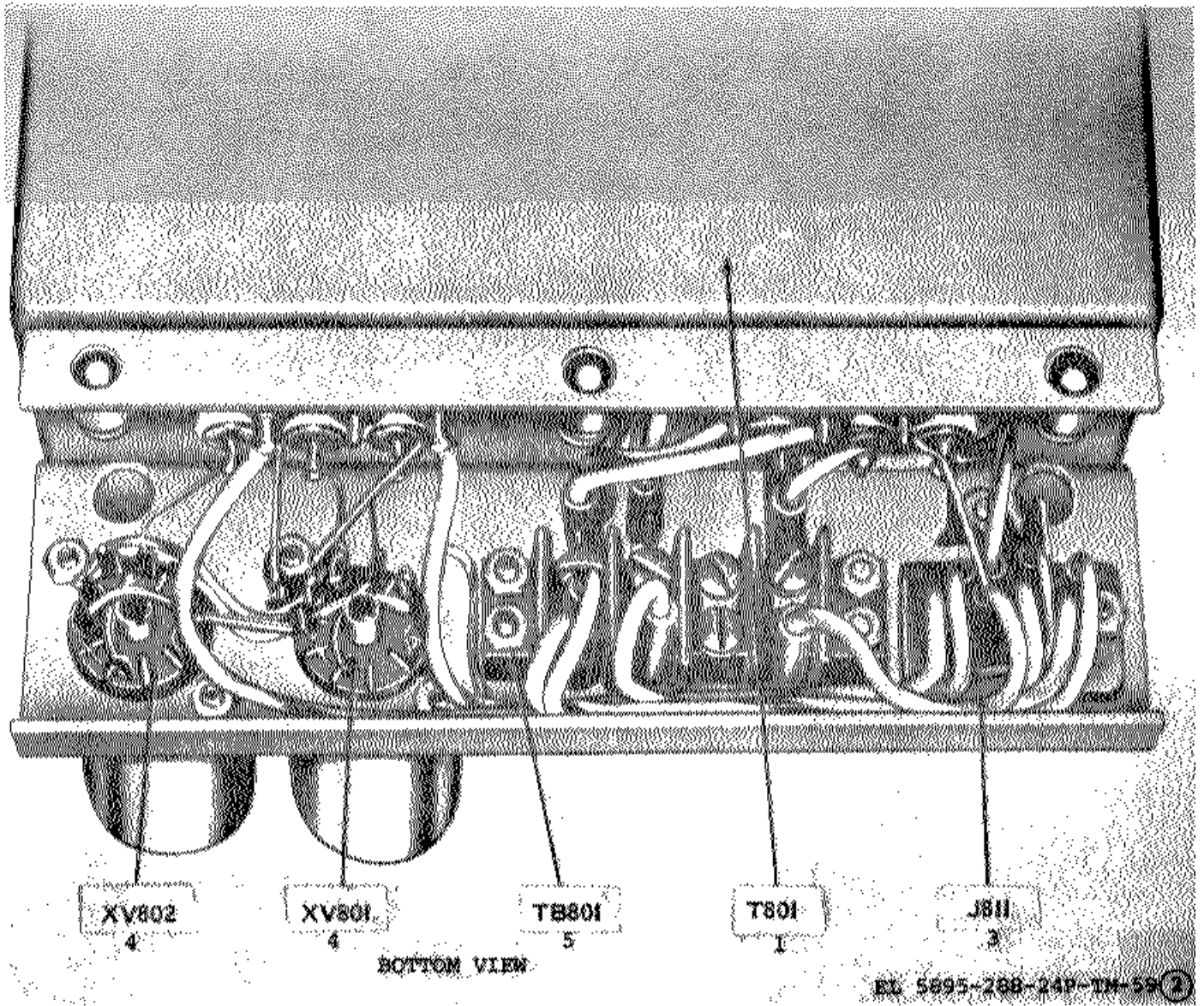

Figure 59. Power Supply Subchassis A1A5 (Sheet 1 of 2)

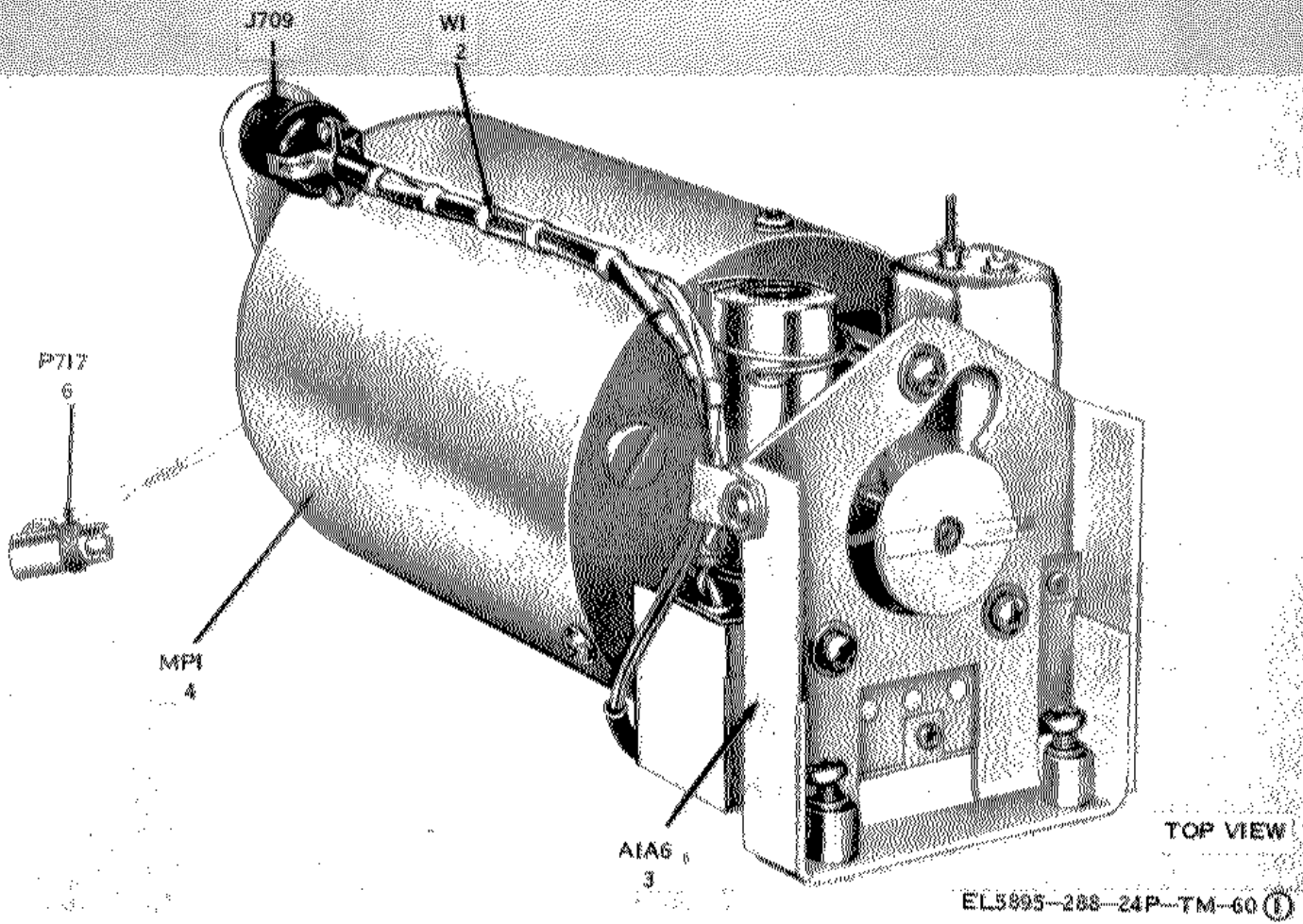

Figure 60. Radio Frequency Oscillator A1A6 (Sheet 1 of 2)

SECTION II. REPAIR PARTS LIST

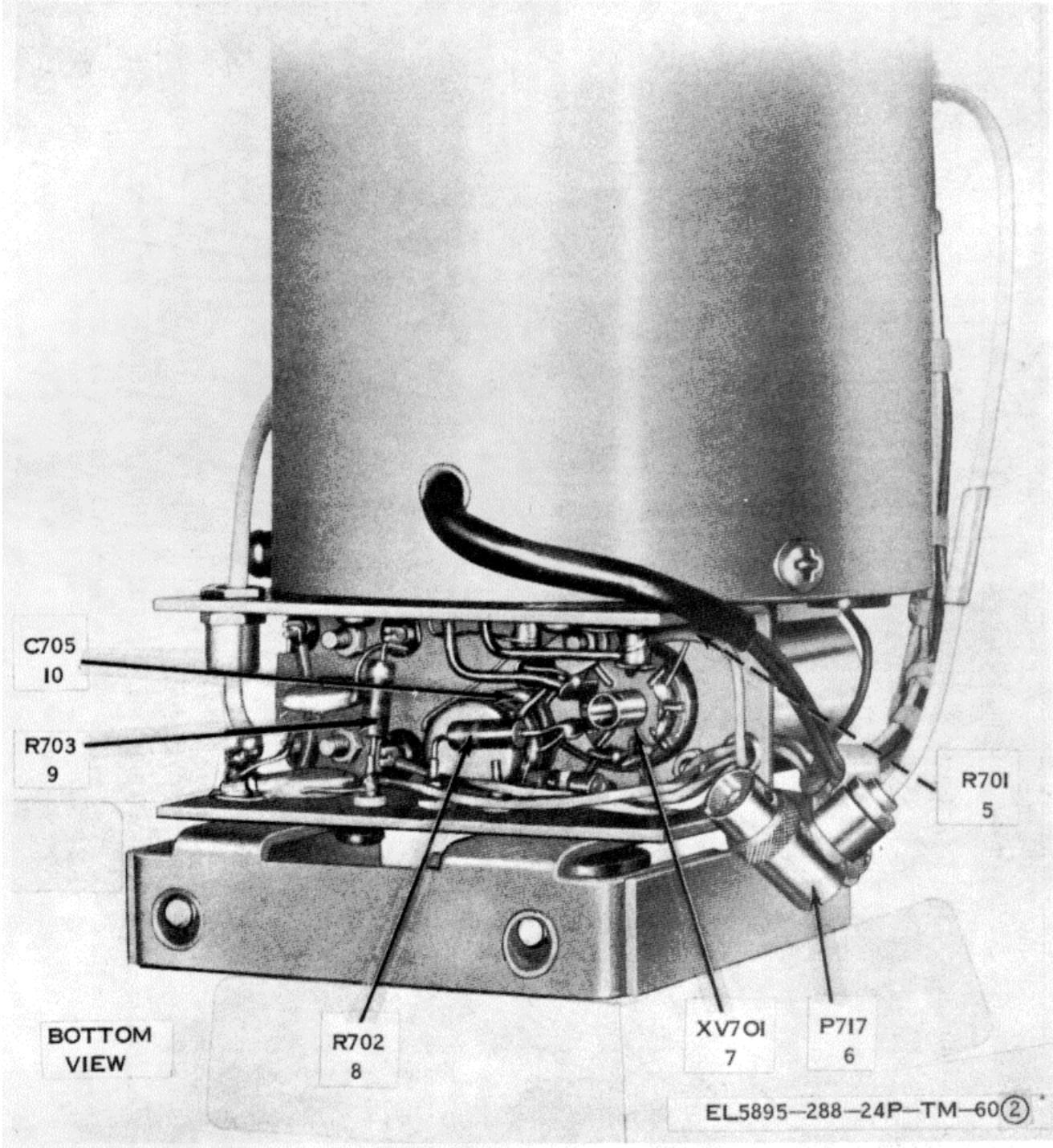

Figure 60. Radio Frequency Oscillator A1A6 (Sheet 2 of 2)

SECTION II. REPAIR PARTS LIST

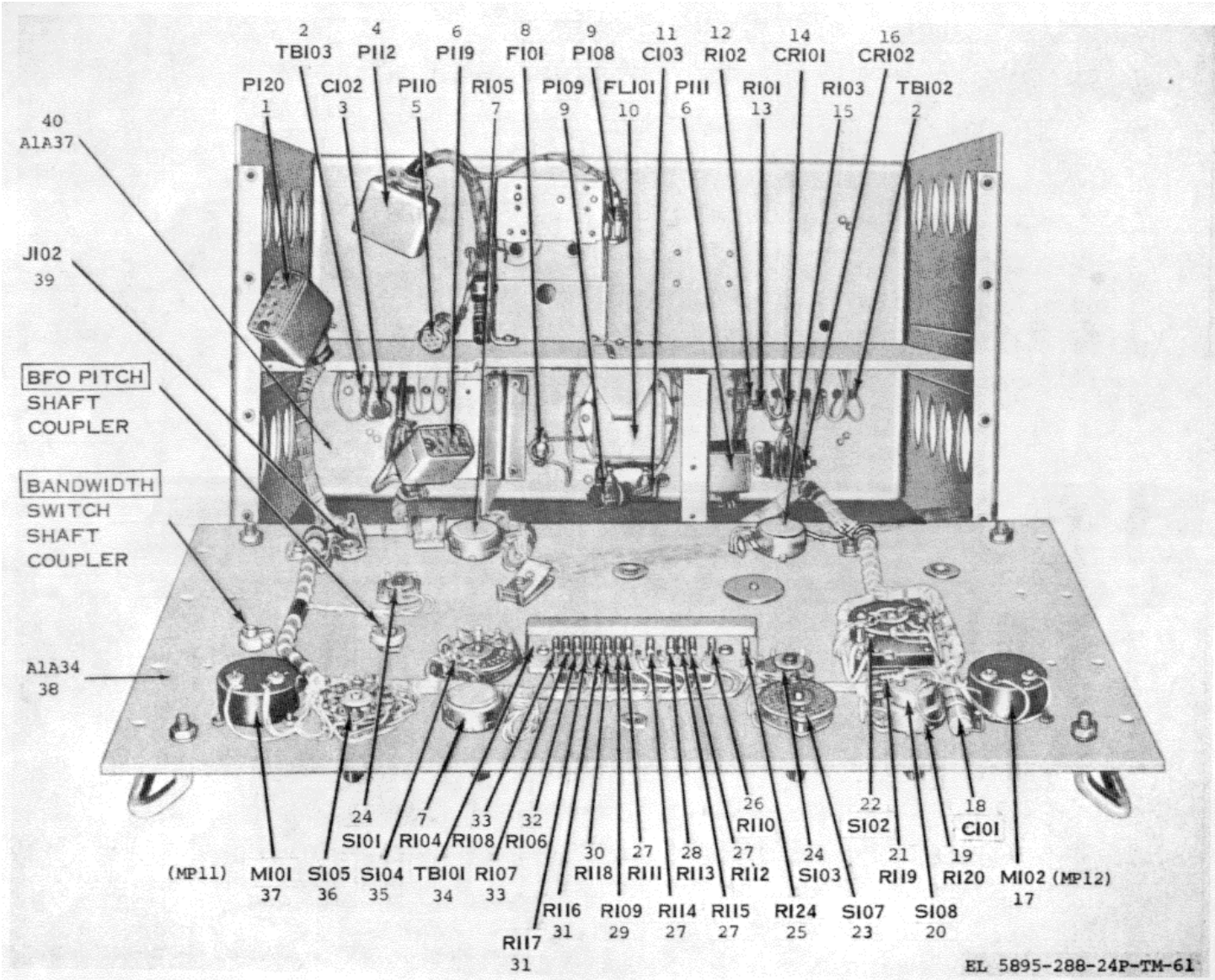

Figure 61. Front Panel Assembly A1A34 and Main Frame

SECTION II. REPAIR PARTS LIST

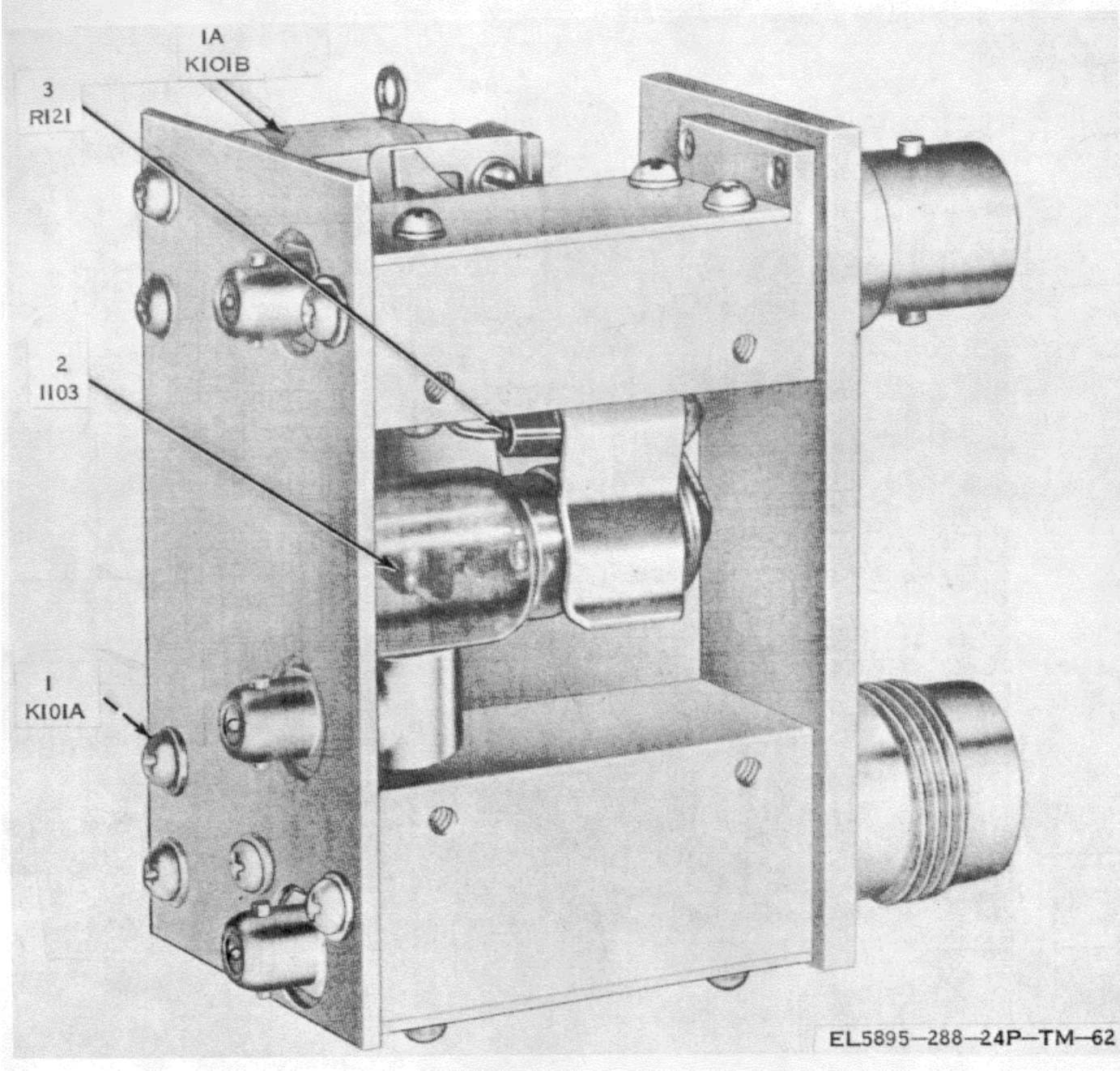

Figure 62. Antenna Relay Assembly

SECTION II. REPAIR PARTS LIST

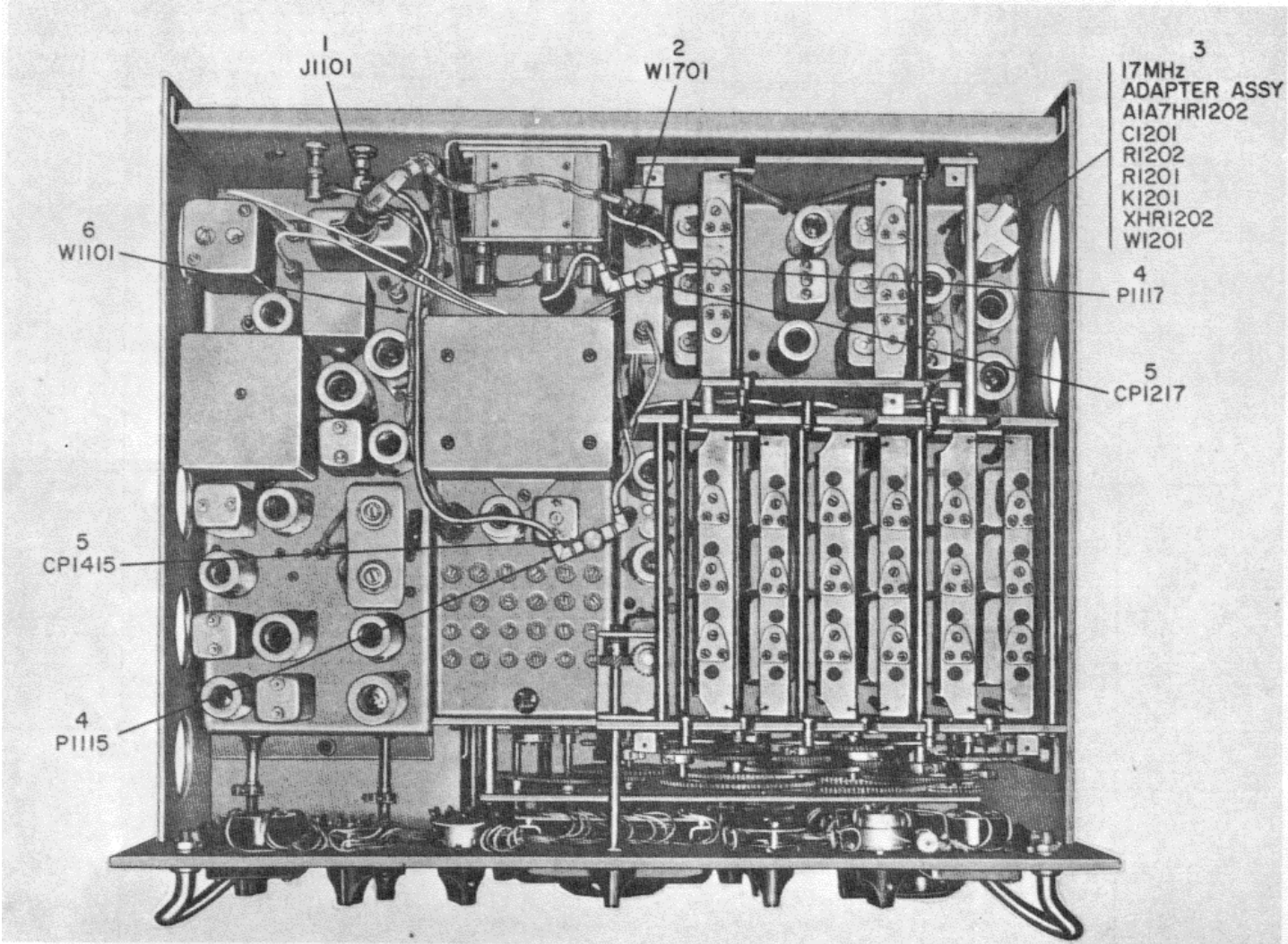
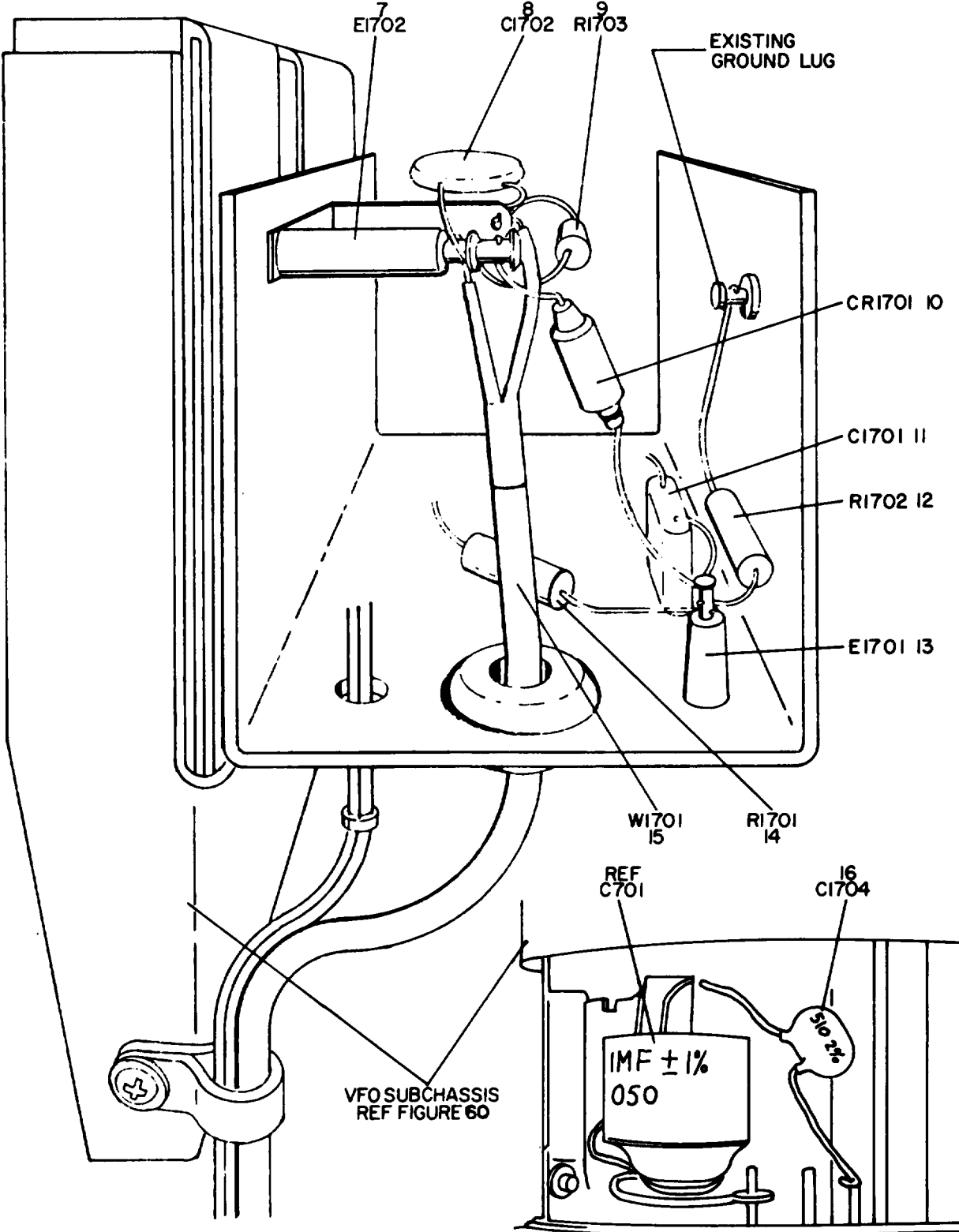

Figure 63. Radio Receiver Modification (Sheet 1 of 3)

SECTION II. REPAIR PARTS LIST



EL 5895-288-24P-TM-63 (2)

Figure 63. Radio Receiver Modification (Sheet 2 of 3)

SECTION II. REPAIR PARTS LIST

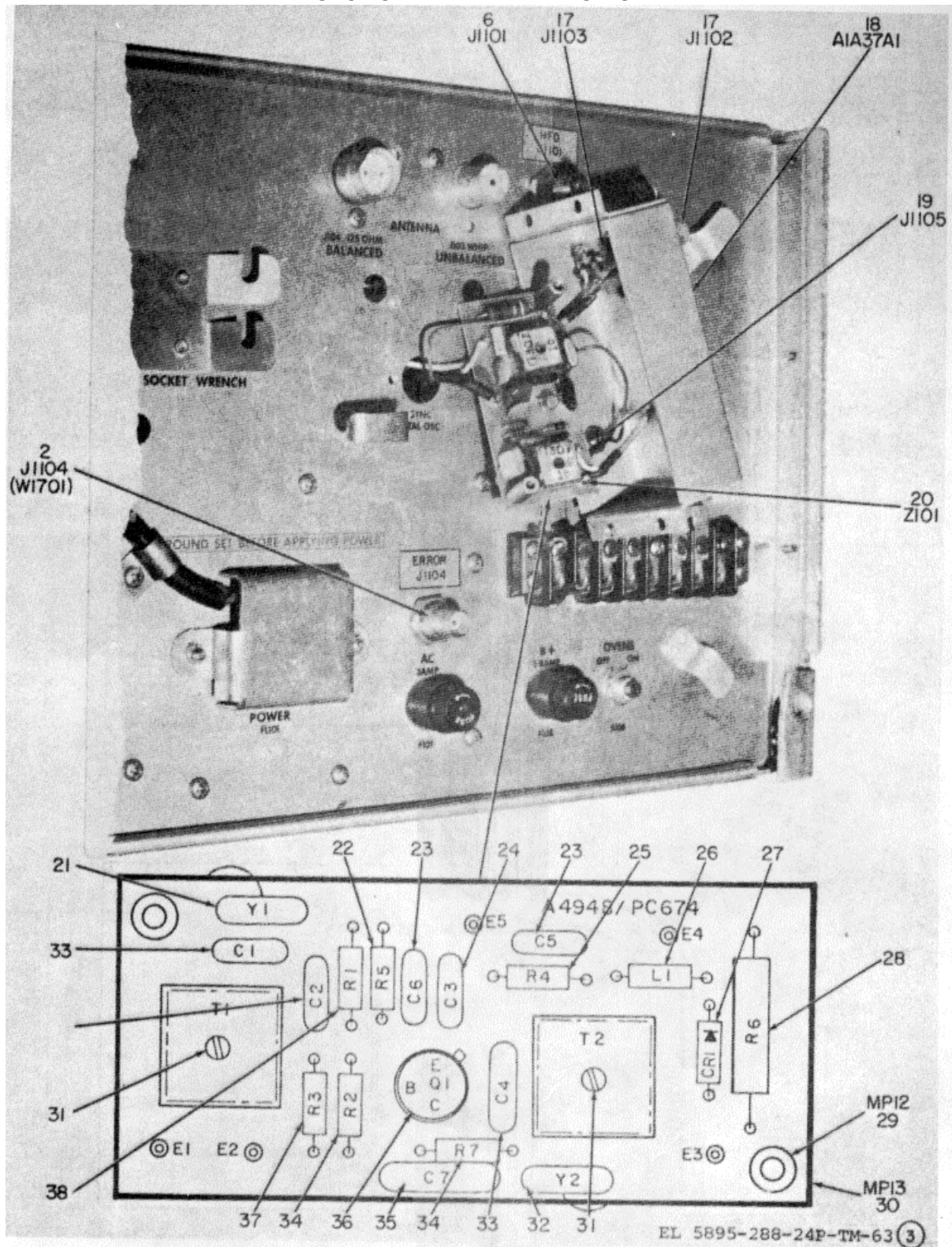
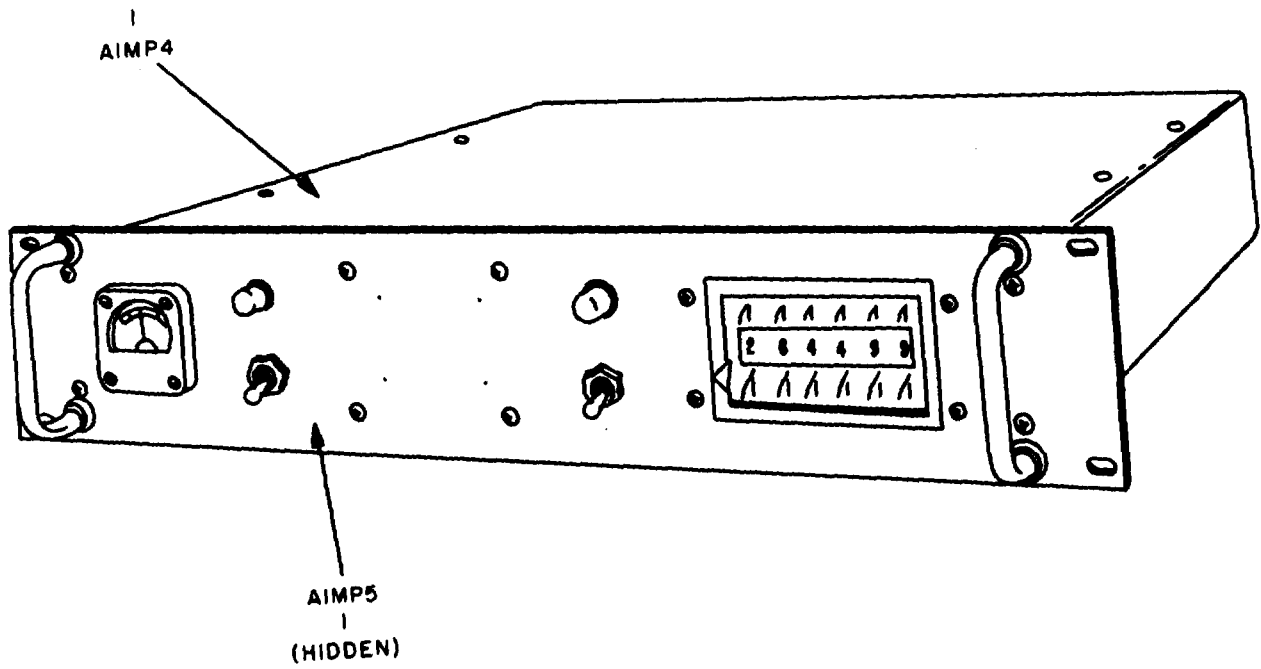

Figure 63. Radio Receiver Modification (Sheet 3 of 3)



EL 5895-288-24P-TM-1

Figure 64. Frequency compensator CN-1448/TSC-25

SECTION II. REPAIR PARTS LIST

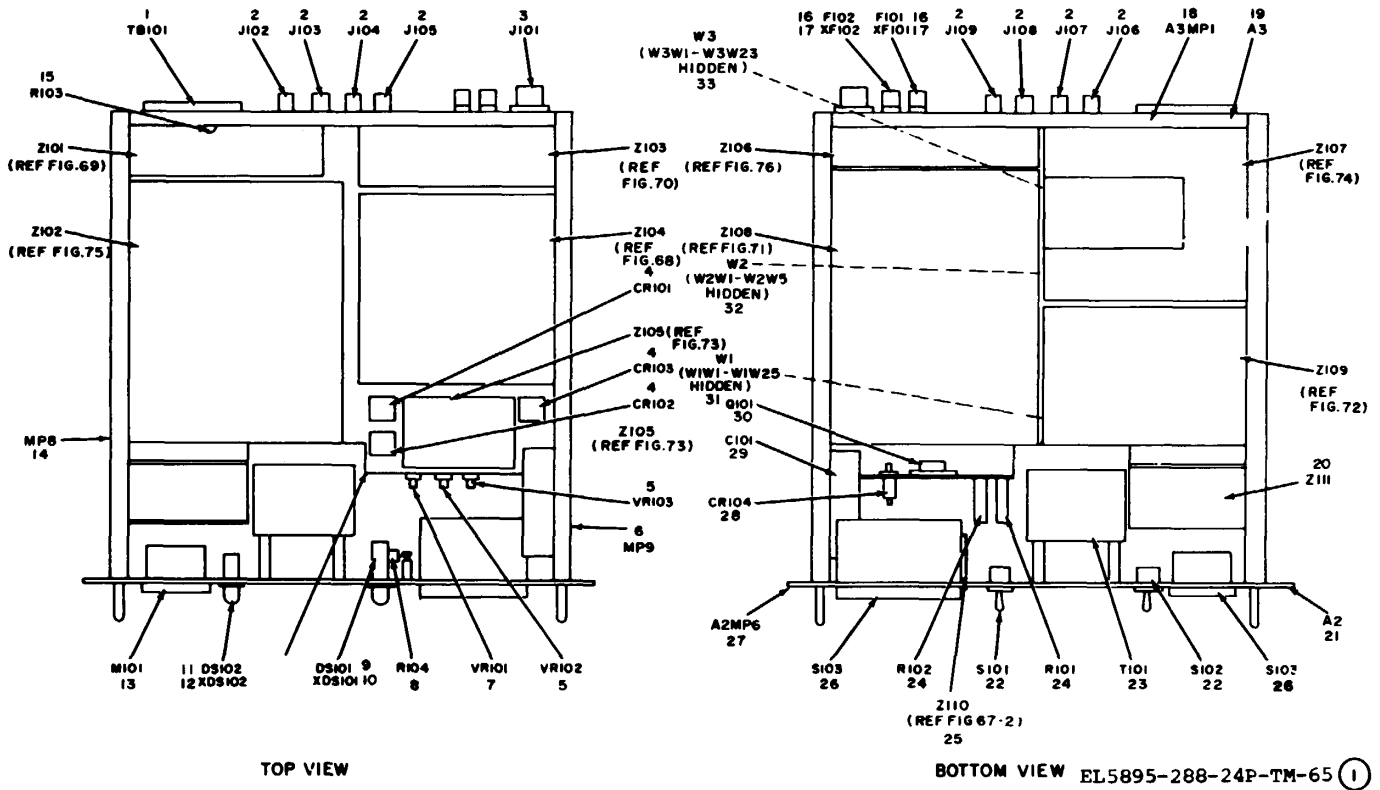
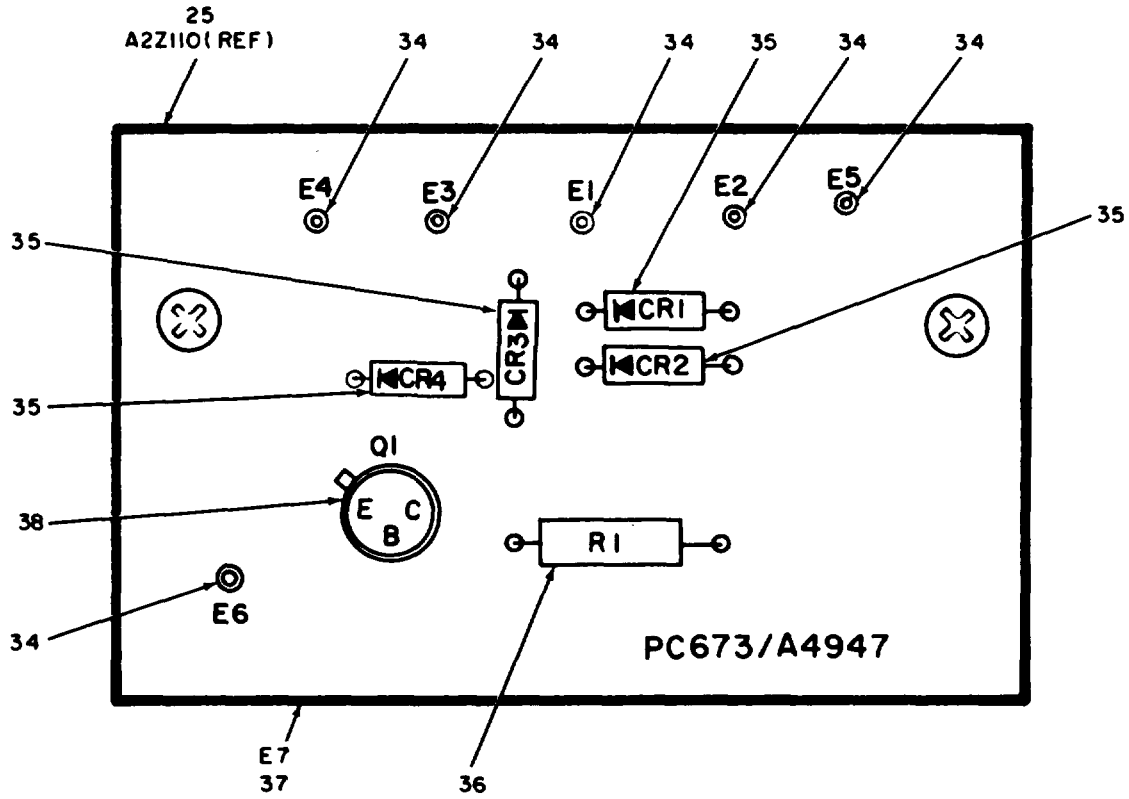

Figure 65. Main Chassis Assembly and Z110 (Sheet 1 of 2)

SECTION II. REPAIR PARTS LIST



EL 5895-288-24P-TM-65

Figure 65. Main Chassis Assembly and ZI10 (Sheet 2 of 2)

SECTION II. REPAIR PARTS LIST

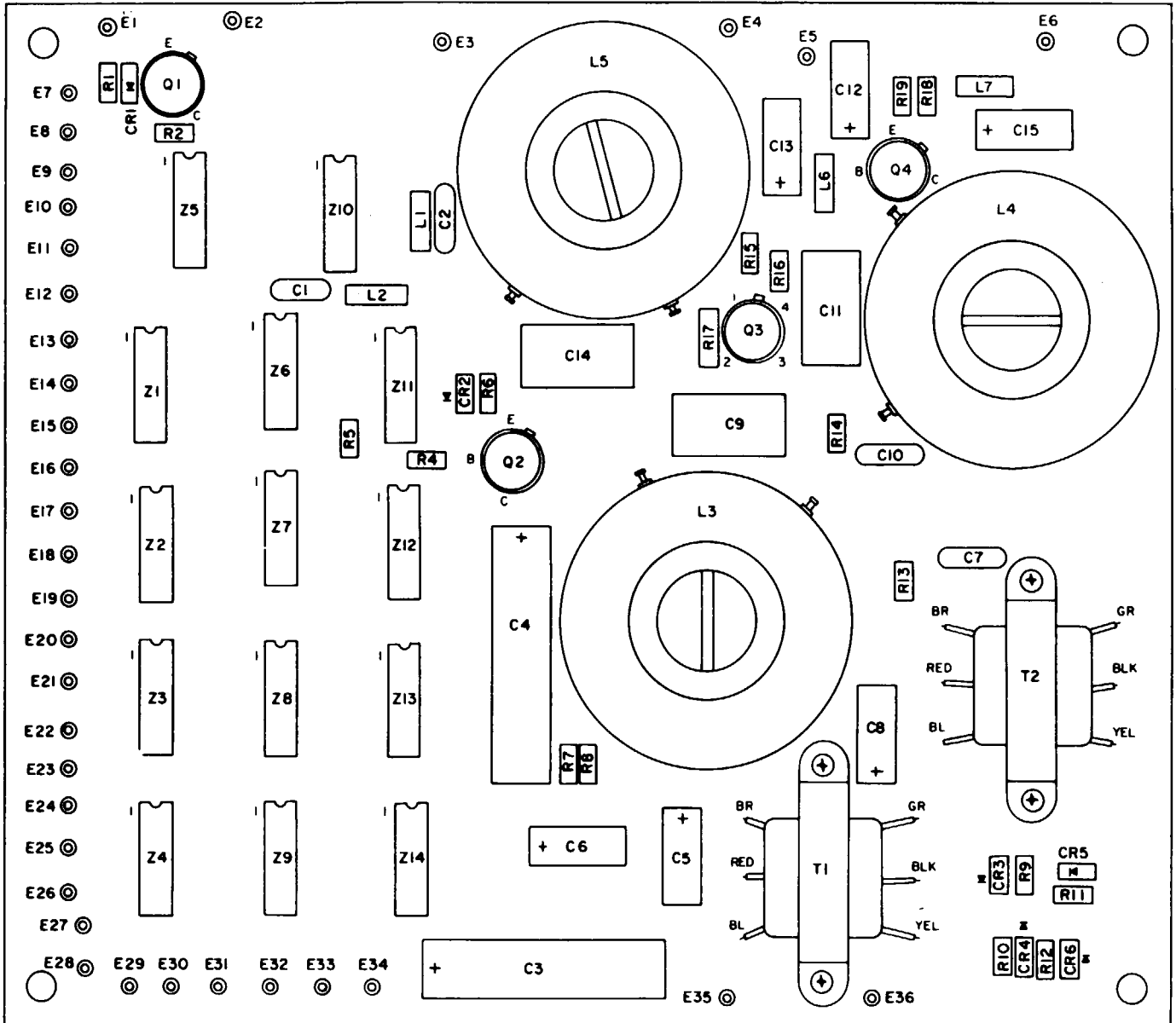

EL 5895-288-24P-TM-66

Figure 66. Programmable Divider Circuit Card Z104

SECTION II. REPAIR PARTS LIST

KEY to fig. 66

Index	Ref Des	Index	Ref Des	Index	Ref Des
1	R1,R2,R4				
2	CR1 thru CR6				
3	Q1,Q2,Q4				
4	Z5 thru Z9				
5	C1				
6	Z10,Z11,Z13,Z14				
7	L1,L2,L6,L7				
8	C2,C7				
9	R6				
10	L3,L4,L5				
11	MP1				
12	MP2				
13	MP3				
14	C9,C11,C14				
15	R14,R16,R17,R18				
16	R15				
17	C5,C6,C8,C12,C13, C15				
18	R19				
19	Q3				
20	C10				
21	R13				
22	T1,T2				
23	R9 thru R12				
24	R7,R8				
25	C3,C4				
26	Z1 thru Z4				
27	Z12				
28	R5				
29	PC1				
30	A4928				
31	MP4				
32	MP5				
33	MP6				

SECTION II. REPAIR PARTS LIST

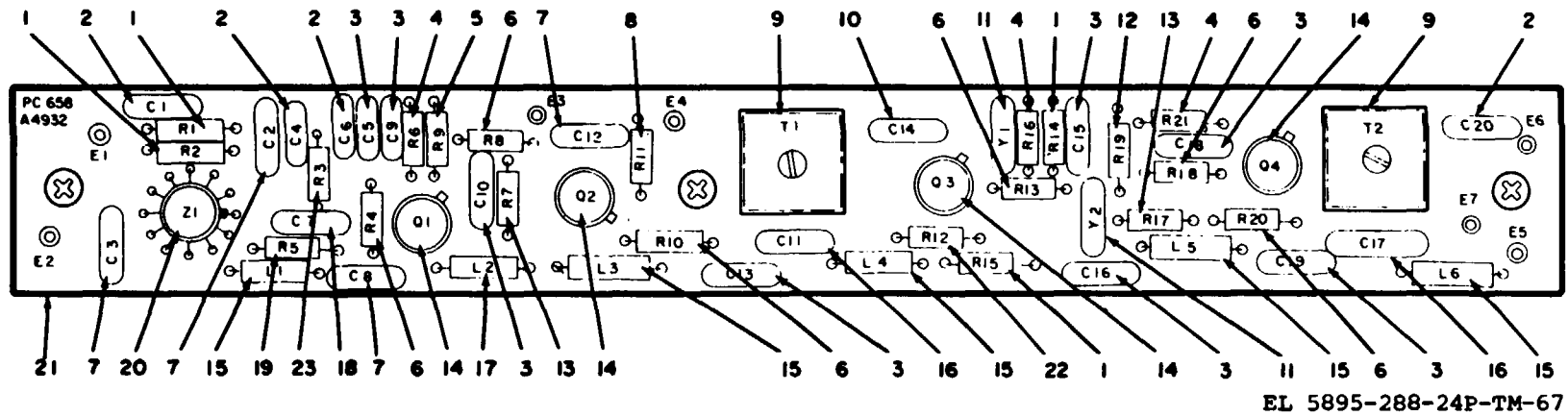
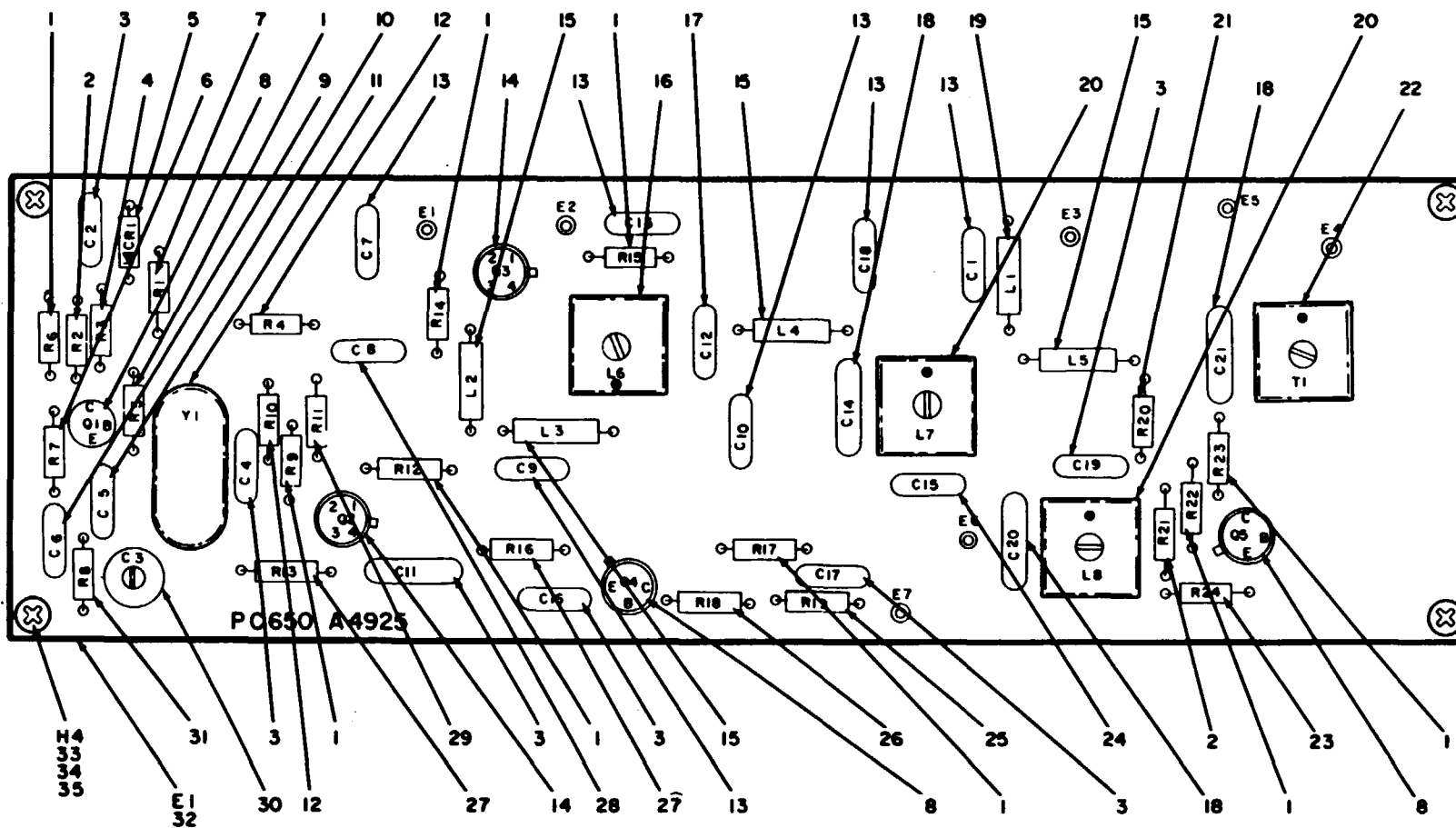

Figure 67. First Mixer Circuit Card Z101

SECTION II. REPAIR PARTS LIST



EL 5895-288-24P-TM-68

Figure 68. Fourth Mixer Circuit Card Z103

SECTION II. REPAIR PARTS LIST

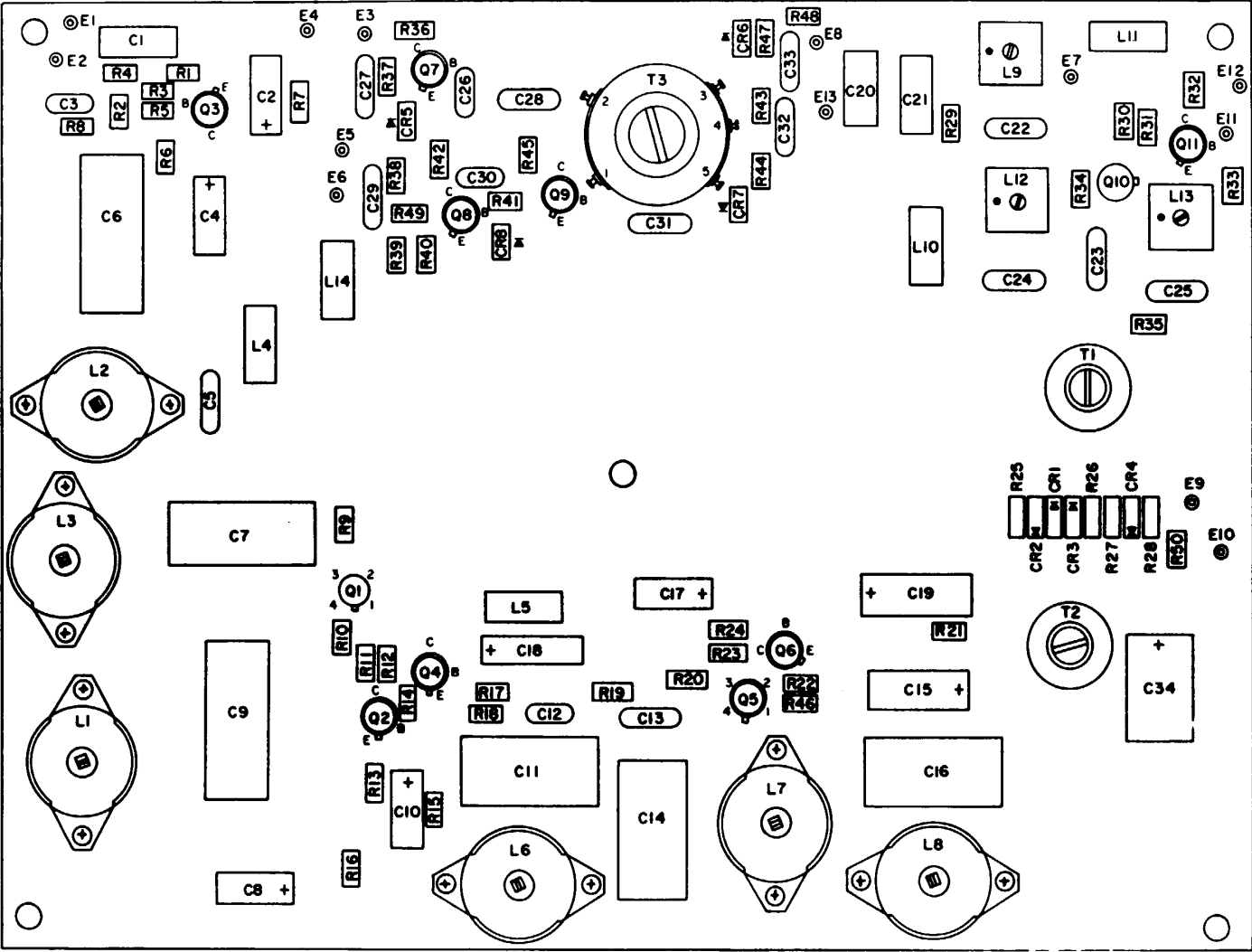

EL-5895-288-24P-TM-69

Figure 69. 10 and 100 kHz Multiplier Circuit Card Z108

SECTION II. REPAIR PARTS LIST

KEY to fig. 69

Index	Ref Des	Index	Ref Des	Index	Ref Des
1	E2 thru E13				
2	E1				
3	C1,C20,C21				
4	C4,C8,C18				
5	Q2,Q3,Q4,Q6,Q7, Q8,Q9,Q11				
6	C2,C15,C17				
7	T3				
8	L9,L12,L13				
9	L4,L5,L10,L11				
10	Q1 ,Q,Q10				
11	L14				
12	T1,T2				
13	C10,C19,C34				
14	L6 thru L8				
15	C11,C14,C16				
16	C6,C7,C9				
17	L1,L2,L3				
18	C3,C12				
19	R4,R43,R44				
20	R3,R5,R9,RI0,RI1, R12,R14,R17,R20, R22,R23,R30,R31, R32,R34,R46,R49,R50				
21	R7				
22	C26,C27,C28,C29,C31, C32,C33				
23	R1,R18,R29,R36,R37, R41,R42, R45,R47				
24	CR5,CR8				
25	R38				
26	CR1,CR2,CR3,CR4, CR6, CR7				
27	R48				
28	C30				
29	R40				
30	R39				
31	R13,R24,R33				
32	R6,R8,RI9,R35				
33	C23				
34	C22,C24,C25				
35	R25 thru R28				
36	R16,R21				
37	C13				
38	R15				
39	C5				
40	R2				
41	MP1				
42	PC1				

SECTION II. REPAIR PARTS LIST

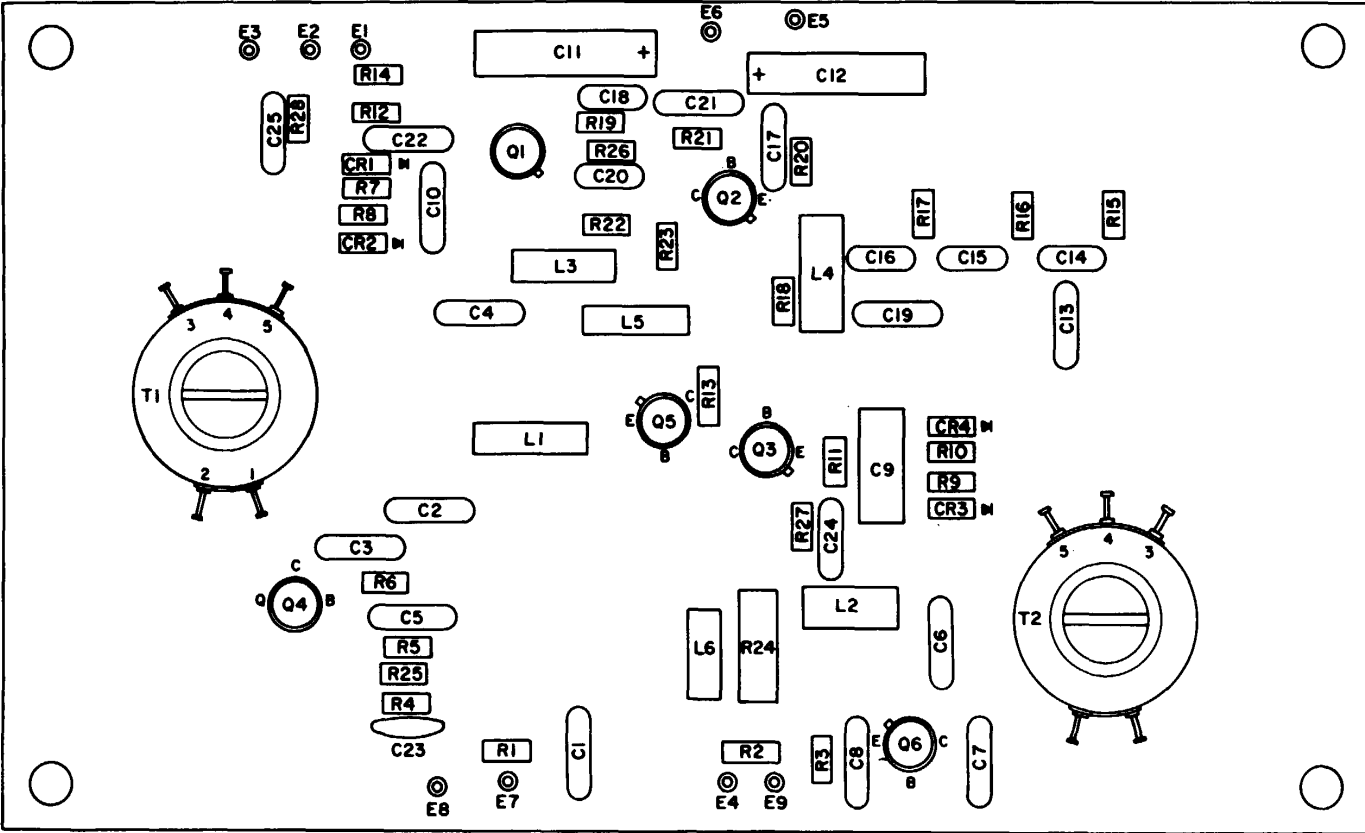

EL 5895-288-24P-TM-70

Figure 70. Phase Detector Circuit Card Z109

SECTION II. REPAIR PARTS LIST

KEY to fig. 70

Index	Ref Des	Index	Ref Des	Index	Ref Des
1	T1,T2				
2	CR1 thru CR4				
3	R6,R7,R8,R9,R10, R23				
4	C25				
5	R28				
6	R12				
7	R14				
8	C1,C2,C4,C5,C6,C8, C10,C13,C19,C21, C22,C24				
9	C11,C12				
10	Q1,Q2,Q4,Q6				
11	C17,C18,C20,C23				
12	R2,R21,R25,R26				
13	R4,R22				
14	R3,R5,R19,R20				
15	L1 thru L6				
16	R13,R15,R16,R17				
17	C16				
18	R18				
19	C14,C15				
20	C9				
21	R11				
22	Q3				
23	R27				
24	C3,C7				
25	QS				
26	R24				
27	R1				
28	E1				
29	H1				
30	H1				
31	H1				
32	H1				
33	H1				
34	H1				

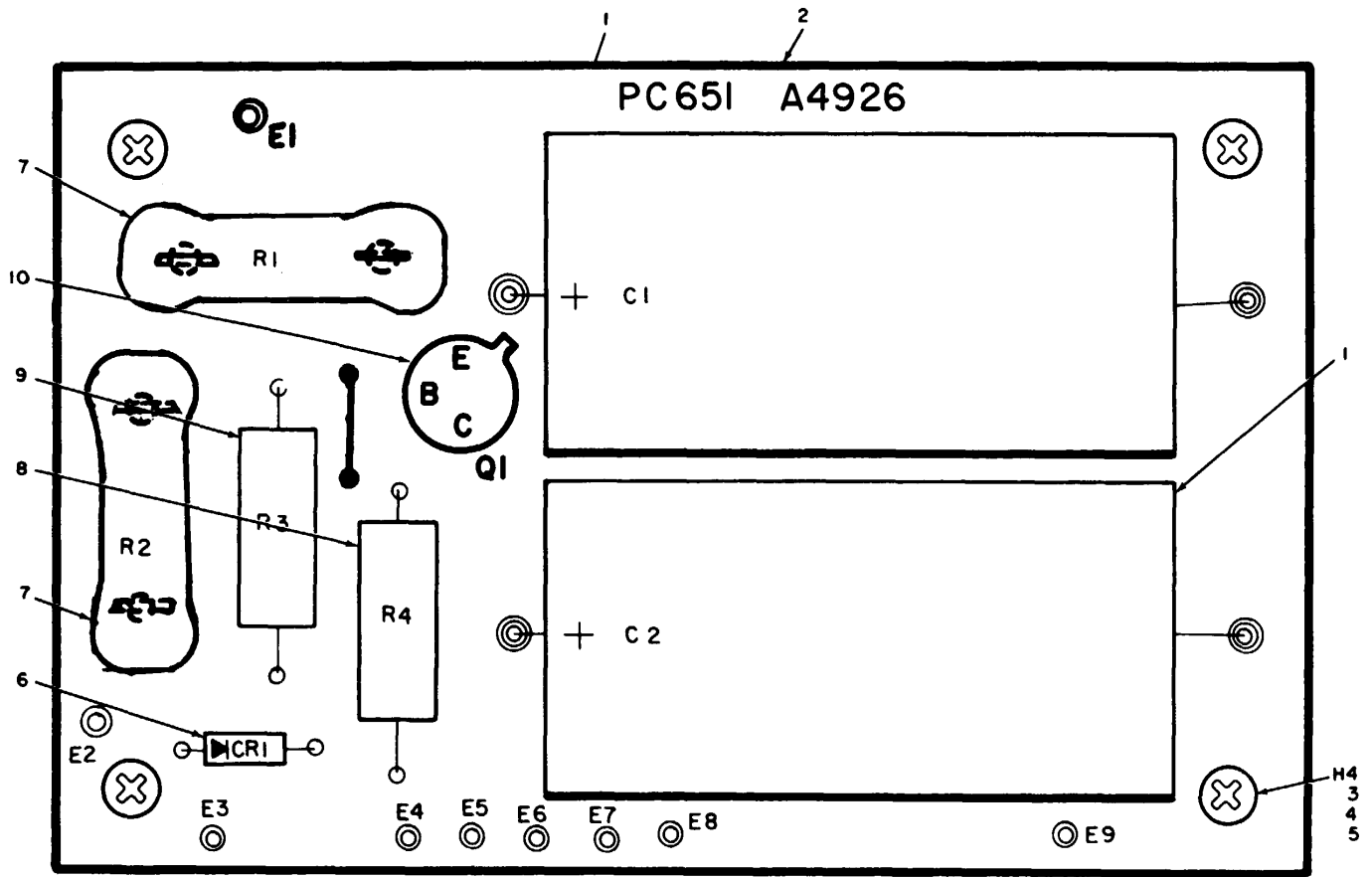

EL 5895-288-24P-TM-71

Figure 71. Power Supply Circuit Card Z105

SECTION II. REPAIR PARTS LIST

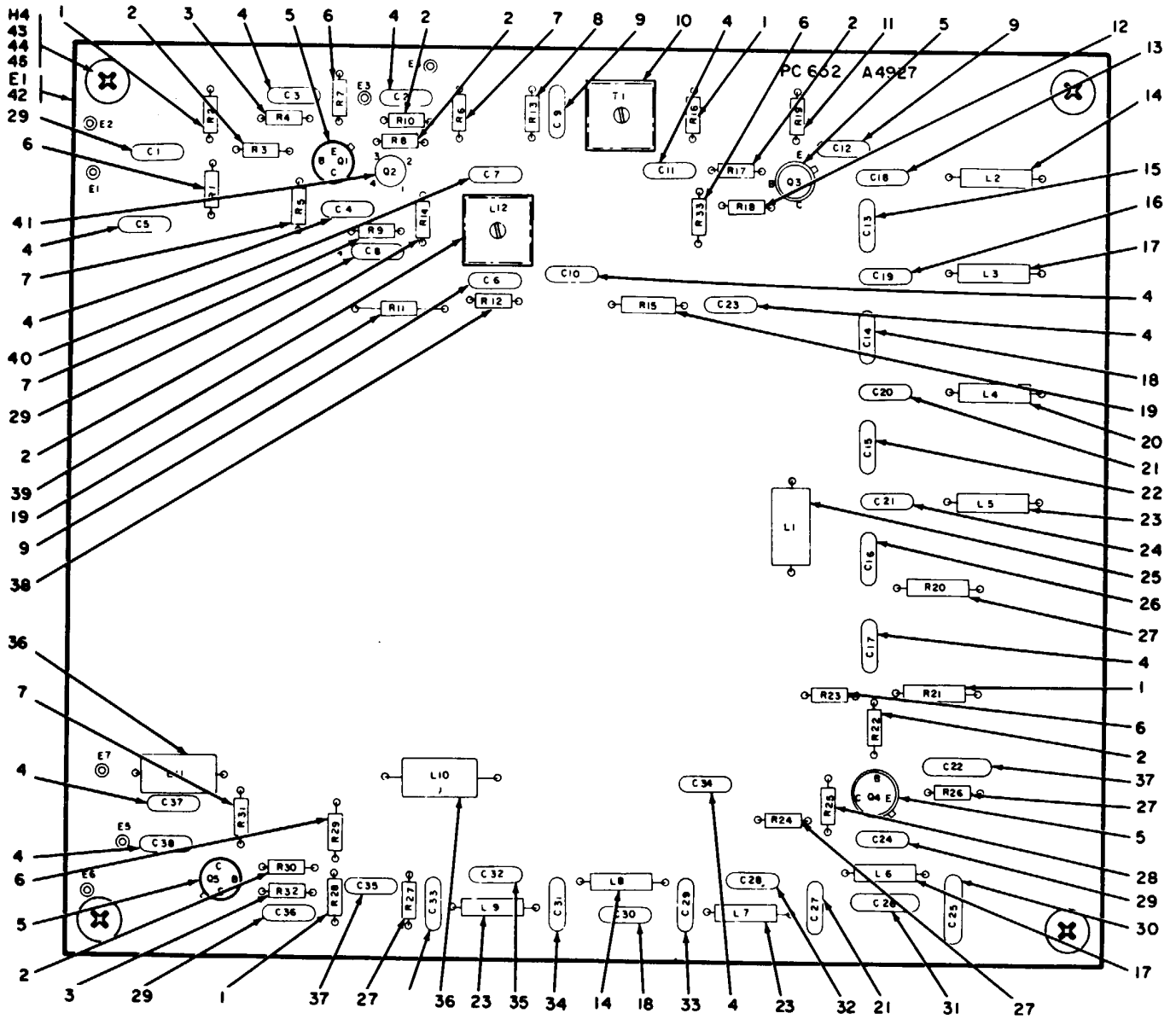

EL 5895-288-24P-TM-72

Figure 72. Second Mixer Circuit Card Z107

SECTION II. REPAIR PARTS LIST

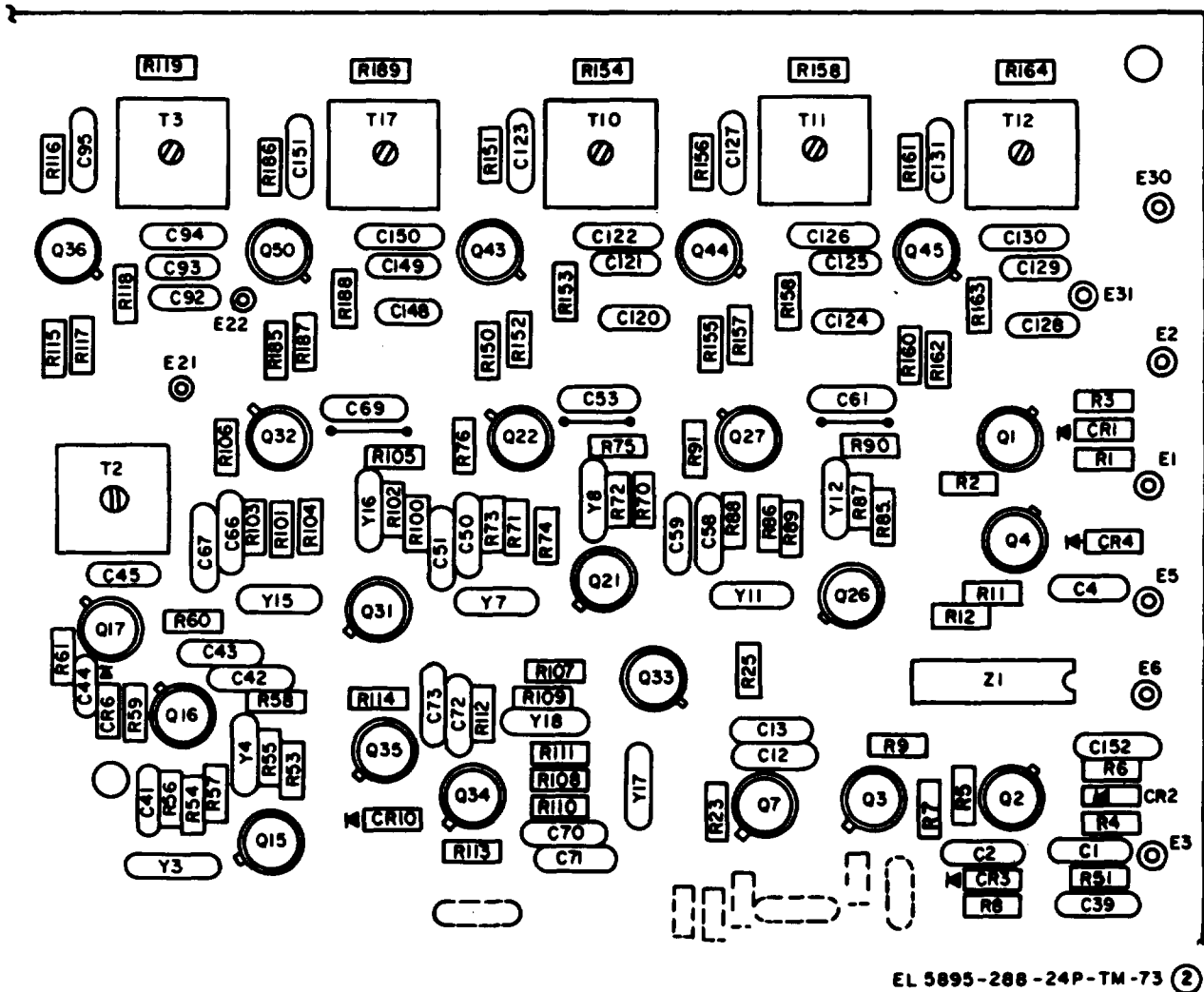
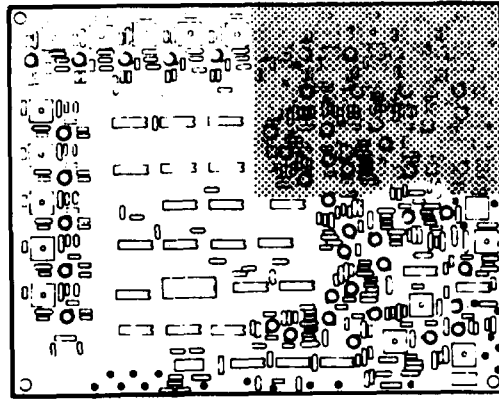

EL 5895-288-24P-TM-73 (2)

Figure 73. Spectrum Generator Circuit Card Z102 (Sheet 2 of 4)

SECTION II. REPAIR PARTS LIST

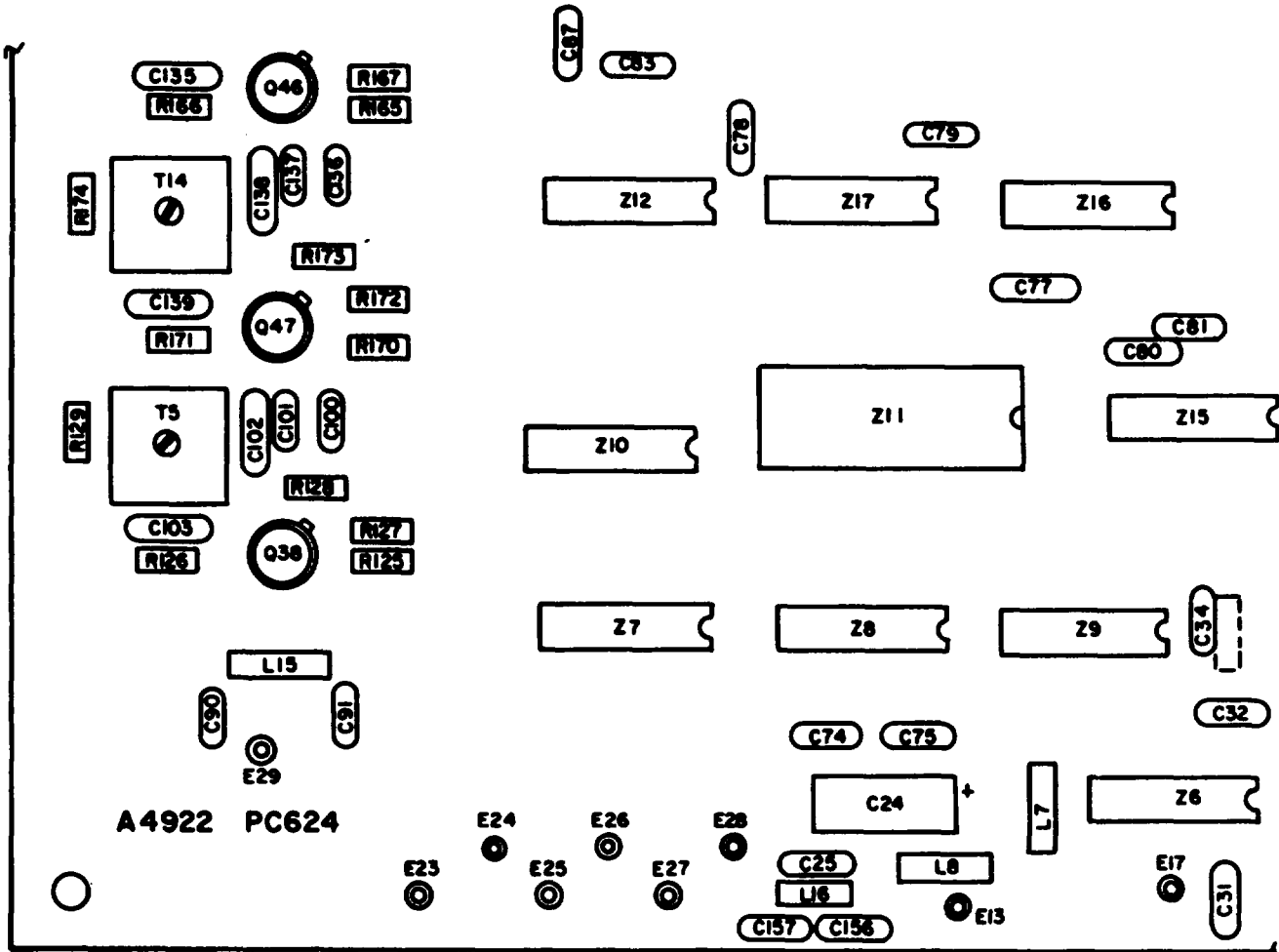
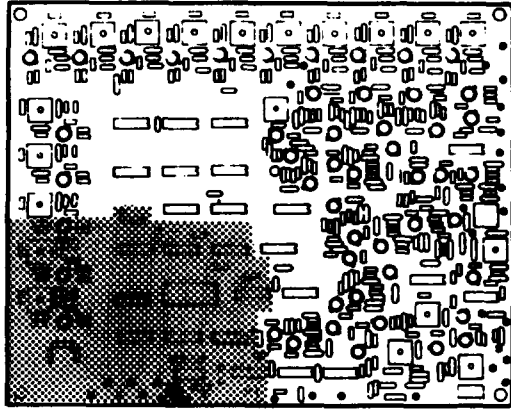

EL-5895-288-24P-TM-73 ⑧

Figure 73. Spectrum Generator Circuit Card Z102 (Sheet 3 of 4)

SECTION II. REPAIR PARTS LIST

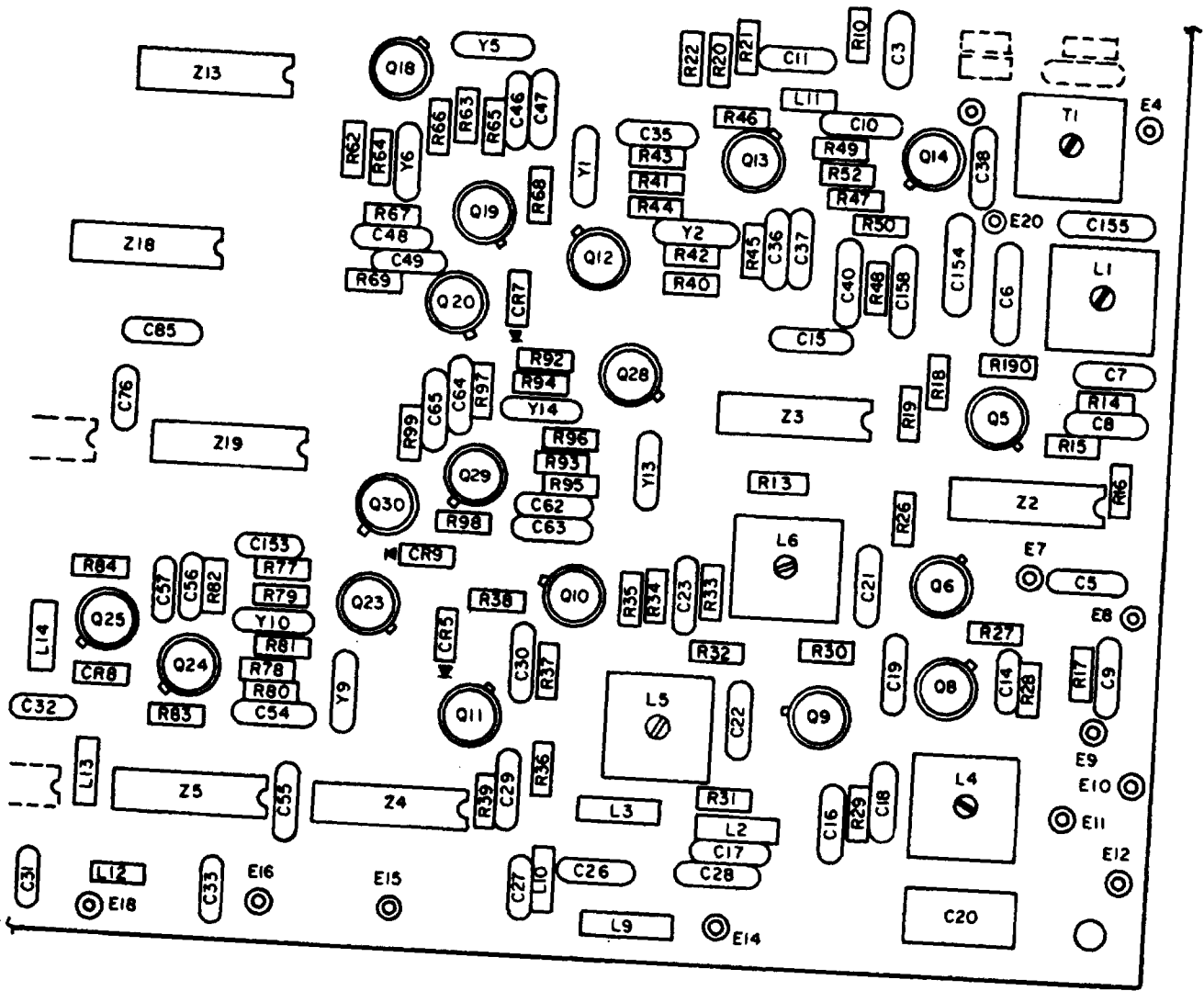
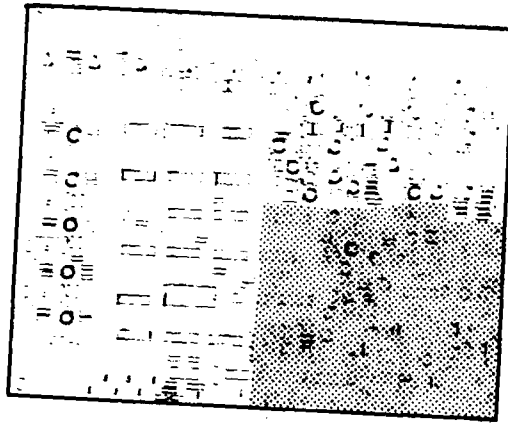

Figure 73. Spectrum Generator Circuit Card Z102 (Sheet 4 of 4)

SECTION II. REPAIR PARTS LIST

KEY to fig. 73

Index	Ref Des	Index	Ref Des	Index	Ref Des
1	R11,R119,R124,R129, R134,R139,R144,R149, R154,R159,R164,R169, R174,R179,R184,R189	30	CR6 thru CR10	44	R7
2	Q1 thru Q8,Q11 thru Q50	31	R14,R19,R23,R29,R52, R117,R122,R127,R132, R137,R142,R147,R152, R157,R162,R167,R172, R177,R182,R187	45	R4,R6,R31,R33, R36,R38 R8,R46,R47 R48
3	T3,T4,T7,T9,T11,T12	32	R3,R6,R10	46	R28
4	T5,T8,T10,T13	33	R15,R21,R30,R32,R35, R34	47	R27
5	T2 R37,R49,R51,R115,	51	R116,R120,R121,R125, R126,R130,R131,R135, R136,R140,R141,R145, R146,R150,R151,R155, R156,R160,R161,R165, R166,R170,R171,R175, R176,R180,R181,R185, R186,R190	48	
6	T17		L7,L8,L11,L12,L13, L16	49	R61
7	T1		R22,R26,R39	50	C11,C12,C14,C23, C30,C35,C36,C37, C41,C42,C43,C44, C46,C48,C49,C50, C53,C54,C56,C57, C58,C61,C62,C64, C66,C69,C70,C72, C73
8	L1		Y1,Y2	52	C13
9	L4,L5,L6		Y13,Y14	53	C6,C154,C158
10	Q9,Q10		CR1 thru CR5	54	C1,C3,C4,C7,C10, C28,C29,C38,C94, C98,C102,C106, C110,C114,C118, C122,C126,C130, C134,C138,C142, C146,C150,C155, C156,C157
11	Z3,Z4,Z5,Z6		Y9,Y10	55	C8
12	Z1,Z9,Z13,Z16,Z17, Z21,Z22		C2,C5,C9,C15,C16,C17, C25,C26,C27,C31,C32, C33,C34,C40,C47,C51, C55,C59,C63,C67,C71, C74,C75,C76,C77,C78, C79,C80,C81,C82,C83, C84,C85,C86,C87,C88, C90,C91,C92,C93,C96, C97,C100,C101,C104, C105,C108,C109,C112, C113,C116,C117,C120, C121,C124,C125,C128, C129,C132,C133,C136, C137,C140,C141,C144, C145,C148,C149,C152, C153	56	C20 C18,C21,C22 Z12 C111 C39,C99 C115 C119 C95 C151 C123 C127 C131 C45 C19 C103 C139 C135 C107 C147
13	C24	34		57	
14	Z2,Z8,Z15		R13,R50,R118,R123, R128,R133,R138,R143, R148,R153,R158,R163, R168,R173,R178,R183, R188	58	
15	Z11	35		59	
16	Z18,Z19,Z20,Z23,Z24	36		60	
17	Z7	37		61	
18	Z10	38		62	
19	Z14,Z25,Z26	39		63	
20	L2,L3,L9,LO1,L14,L15	40		64	
21	T16			65	
22	R20,R40,R53,R62,R70, R77,R85,R92,R100, R107			66	
23	RI,R2,R5,R9,R12,R18, R41,R42,R43,F44,F45, R54,R55,R56,R58,R60 R63,R64,R65,R67,R69, R71,R72,R73,R75,R78, R79,R80,R82,R84,R86, R87,R88,R90,R93,R94, R95,R97,R99,R101, R102,R103,R105,R108, R110,R112,R114	41		67	
24	R46,R57,R59,R66,R68, R74,R76,R81,R83,R91, R96,R98,R104,R111, R113	42		68	
25	Y16,Y15	43		69	
26	Y7,Y8			70	
27	YI,Y11			71	
28	Y18,Y17			72	
29	R25			73	
				74	
				75	
				76	
				78	T6,T15,T14

SECTION II. REPAIR PARTS LIST

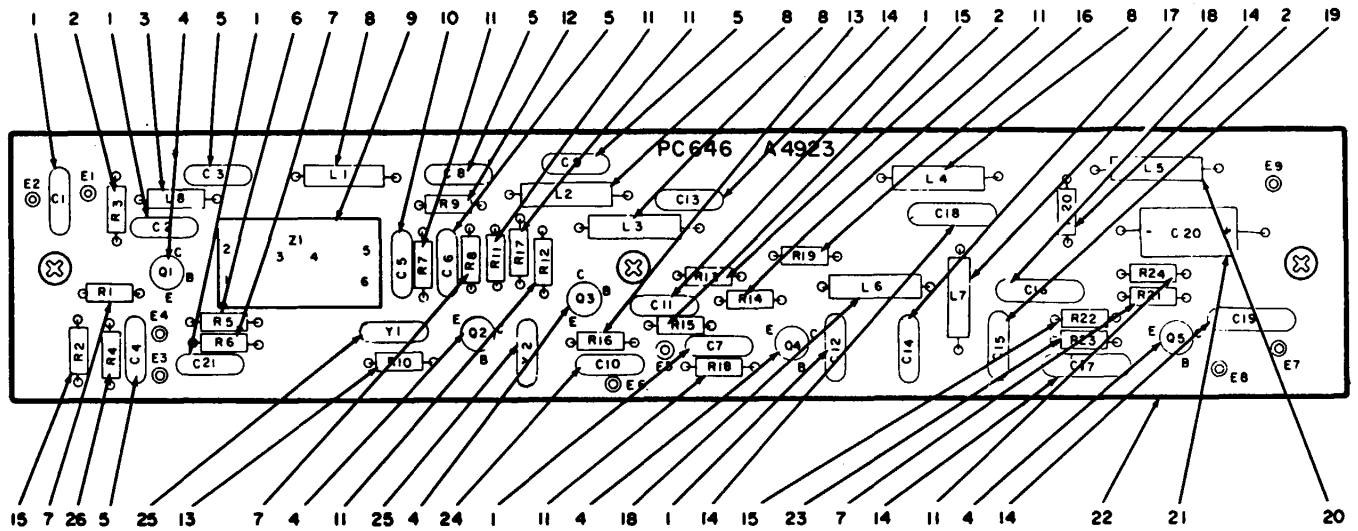

EL 5895-288-24P-TM-74

Figure 74. Third Mixer Circuit Card Z106

SECTION II. REPAIR PARTS LIST

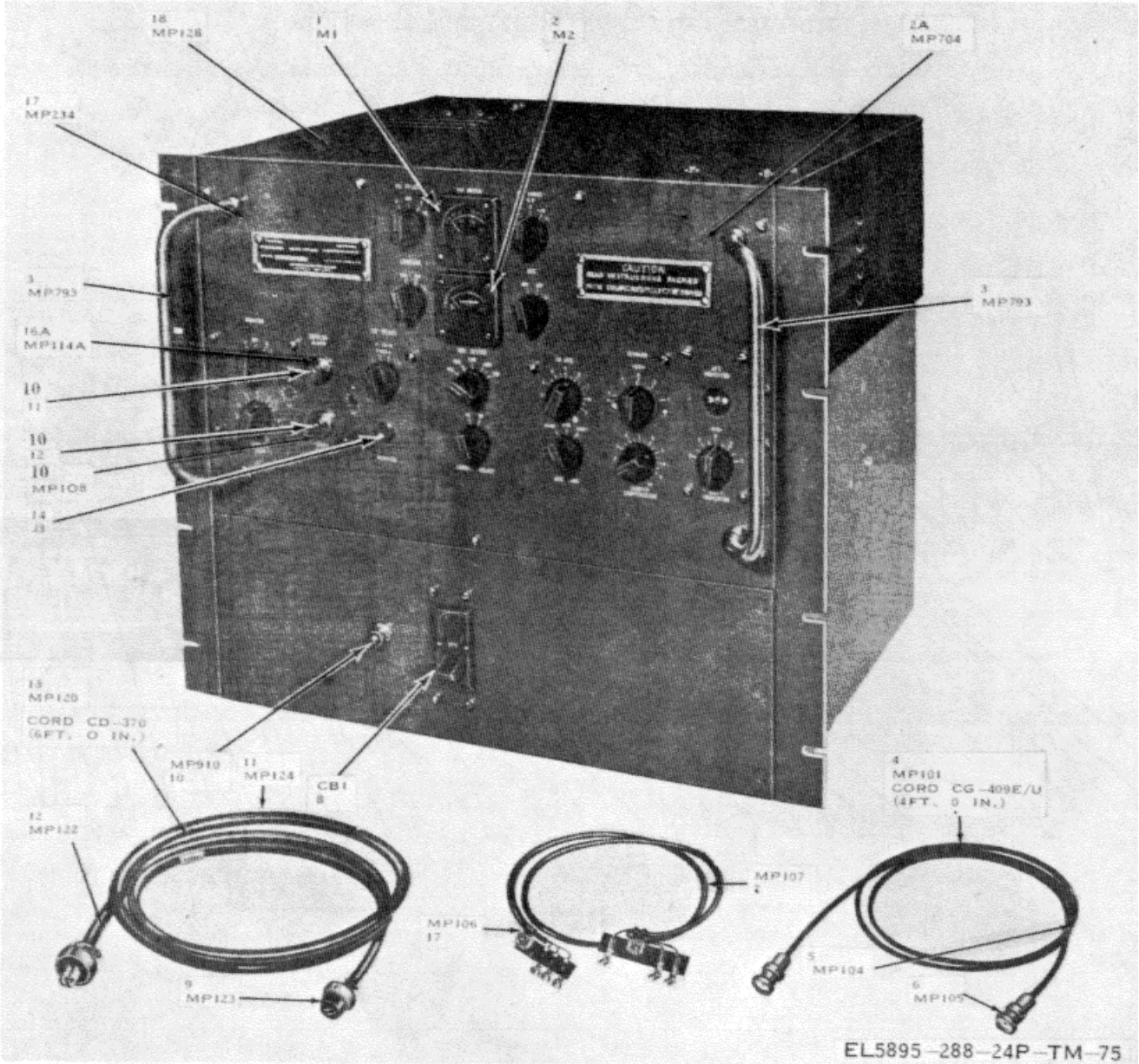
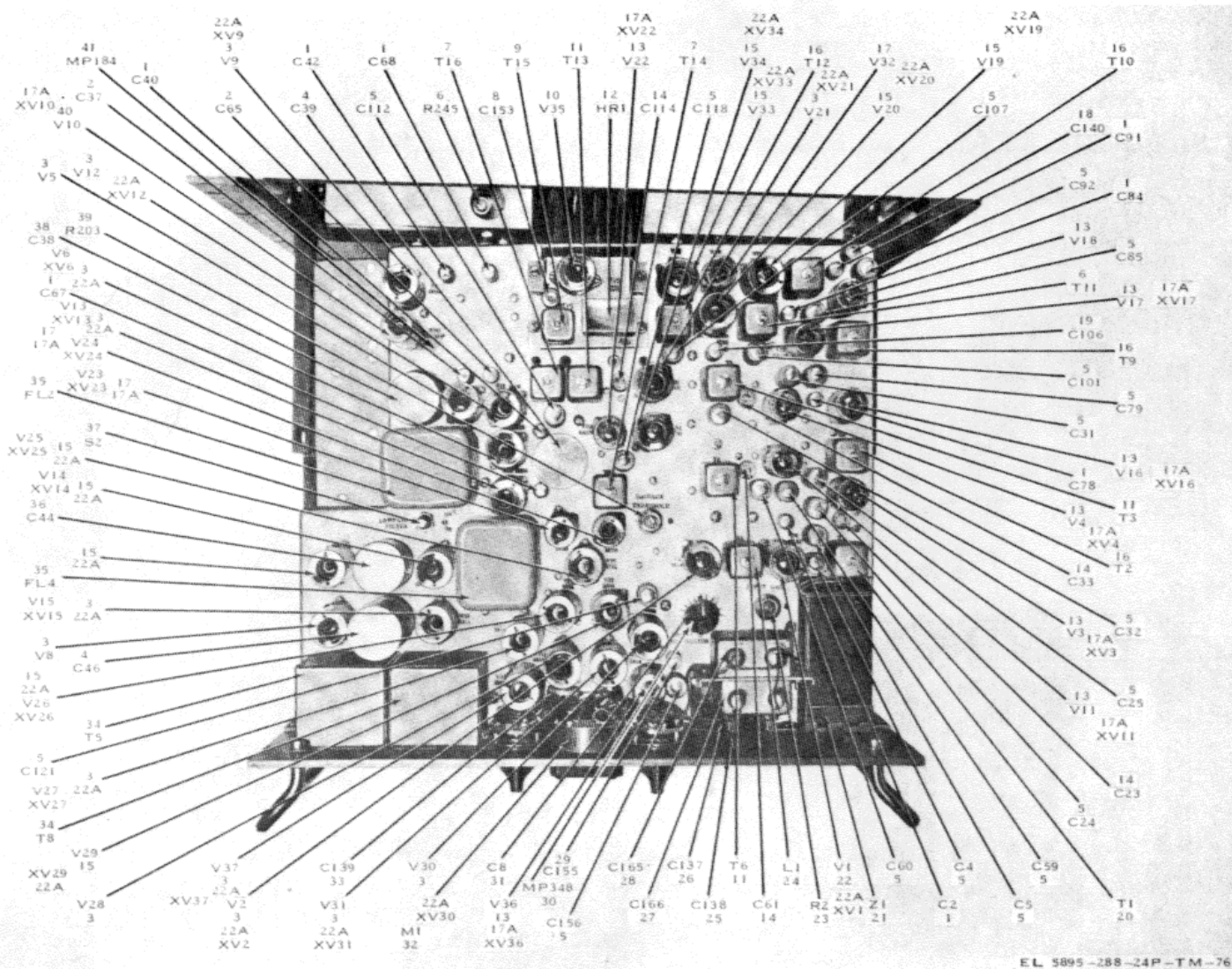

Figure 75. Single-Double Sideband Converter CV-3300/TSC-25, and Operating Components

SECTION II. REPAIR PARTS LIST



EL 5895-288-24P-TM-76

Figure 76. Converter Drawer Assembly, Top View

SECTION II. REPAIR PARTS LIST

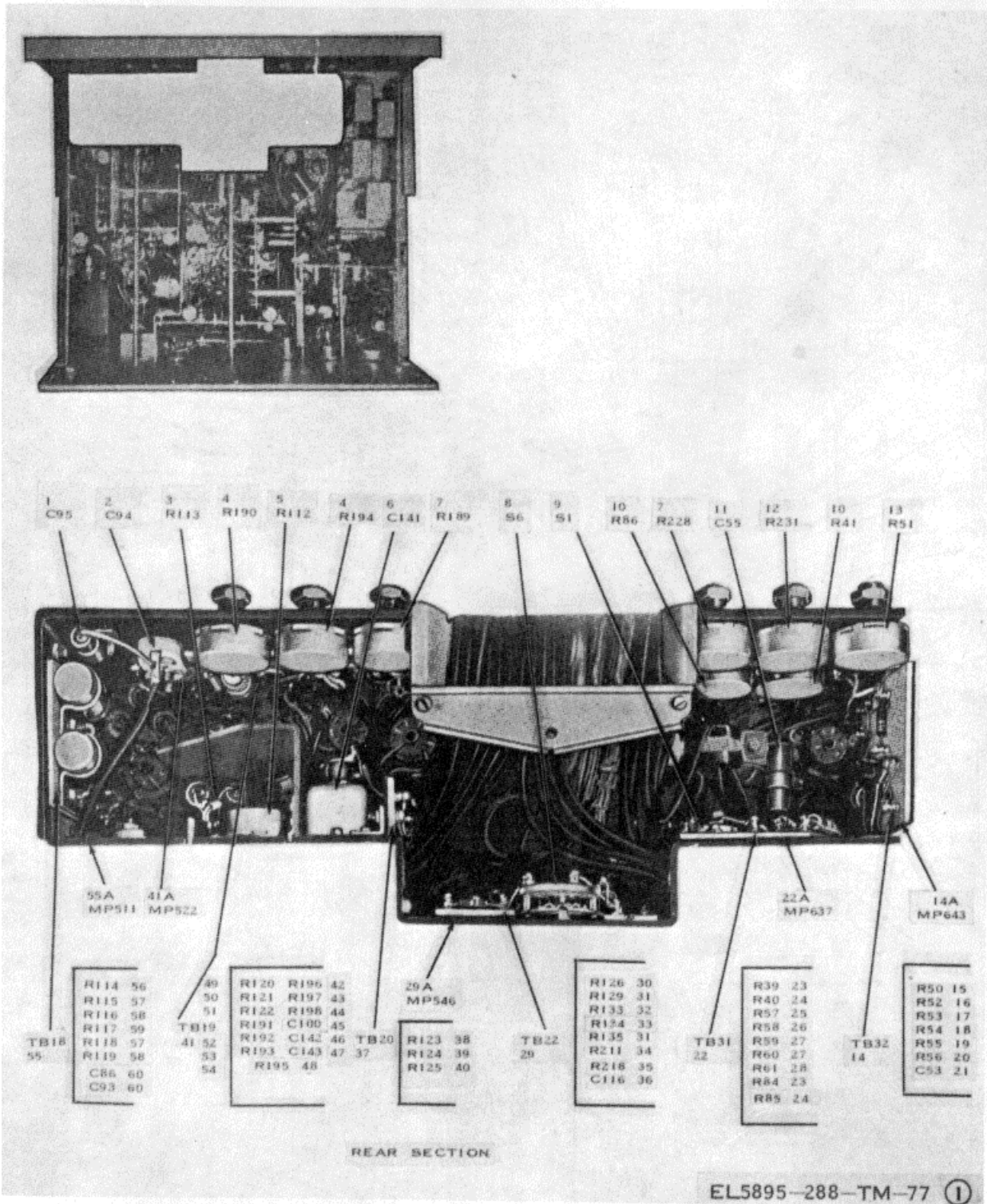

Figure 77. Converter Drawer Assembly, Bottom View (Sheet 1 of 4)

SECTION II. REPAIR PARTS LIST

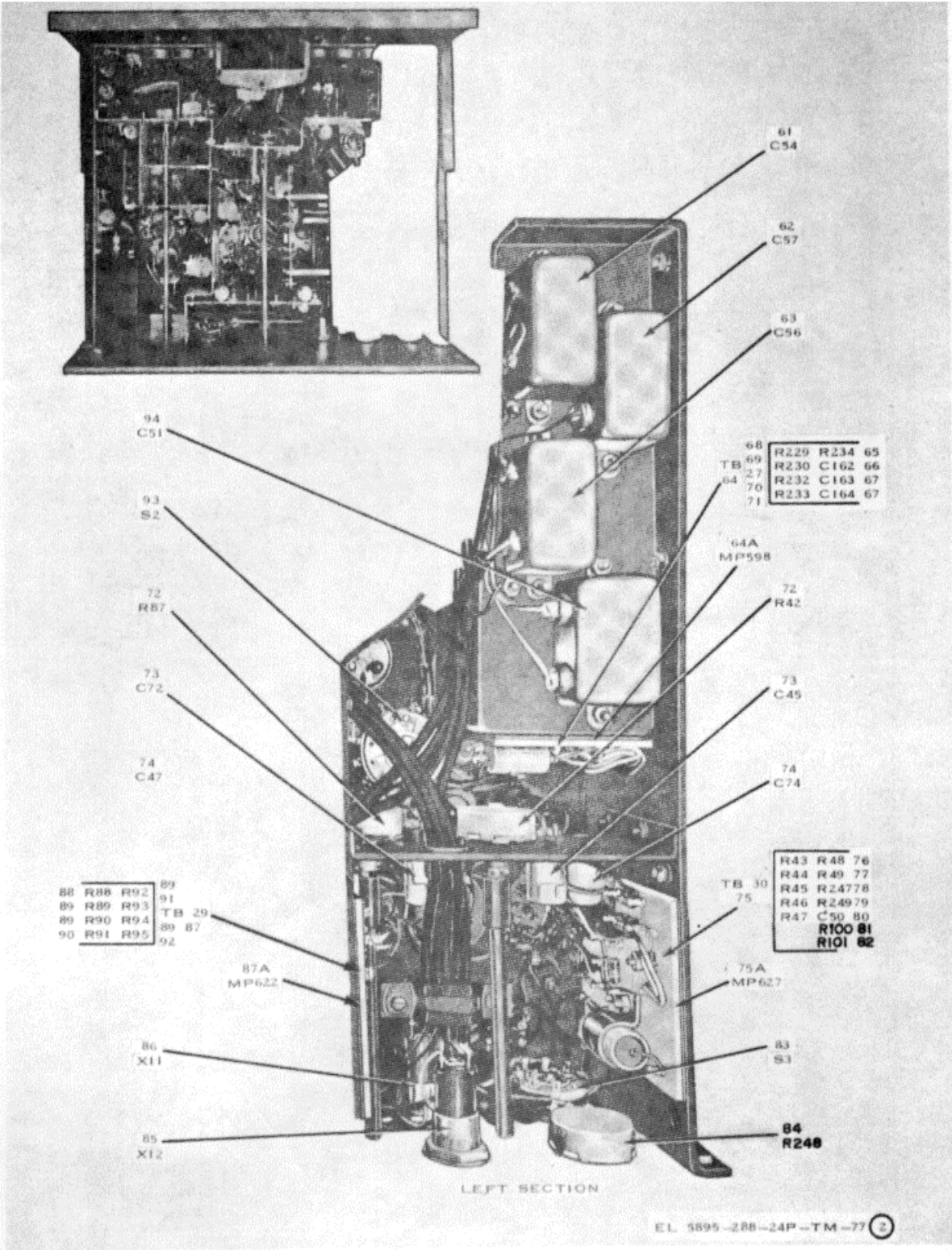

Figure 77. Converter Drawer Assembly, Bottom View (Sheet 2 of 4)

SECTION II. REPAIR PARTS LIST

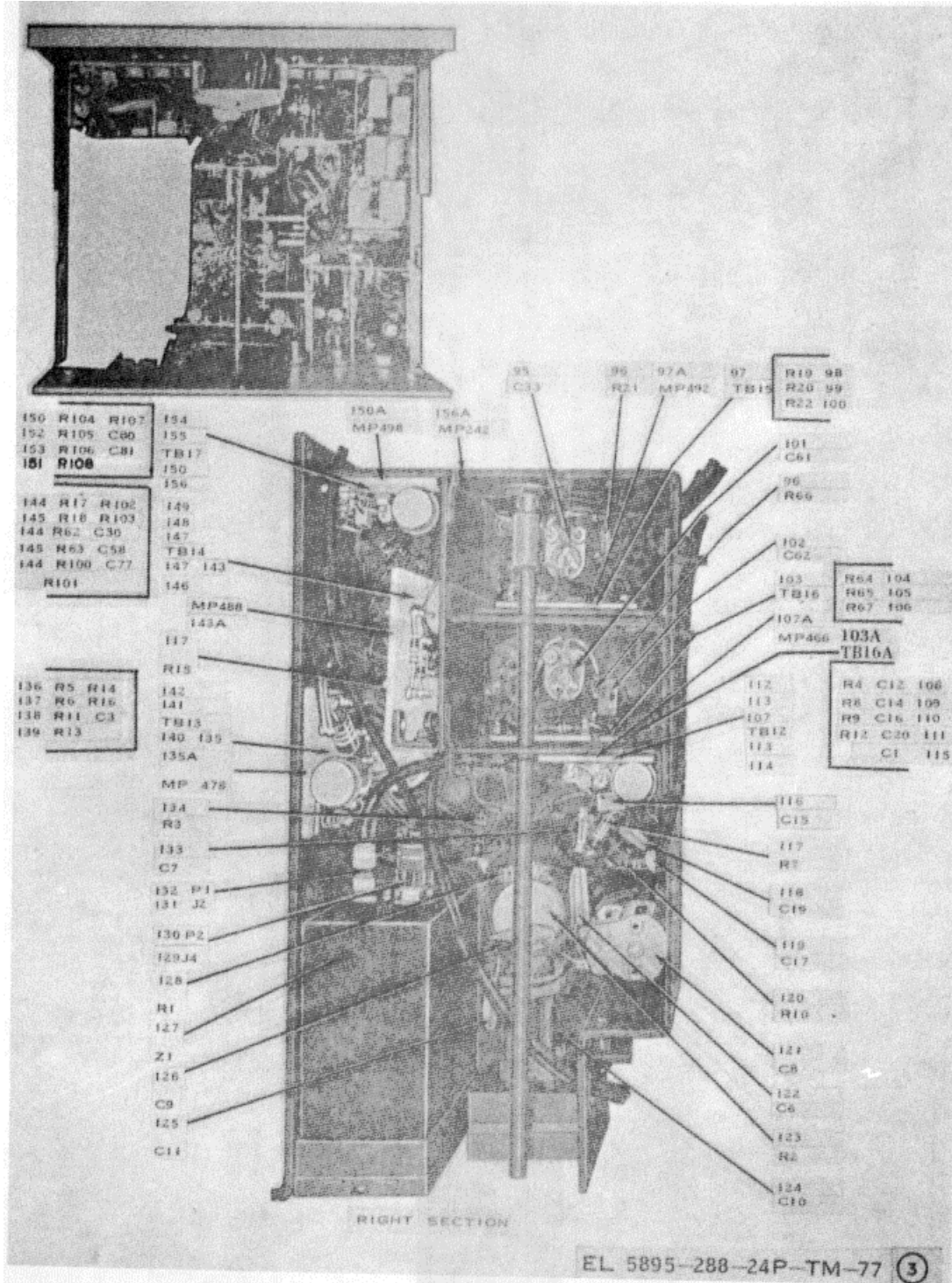

Figure 77. Converter Drawer Assembly, Bottom View (Sheet 3 of 4)

SECTION II. REPAIR PARTS LIST

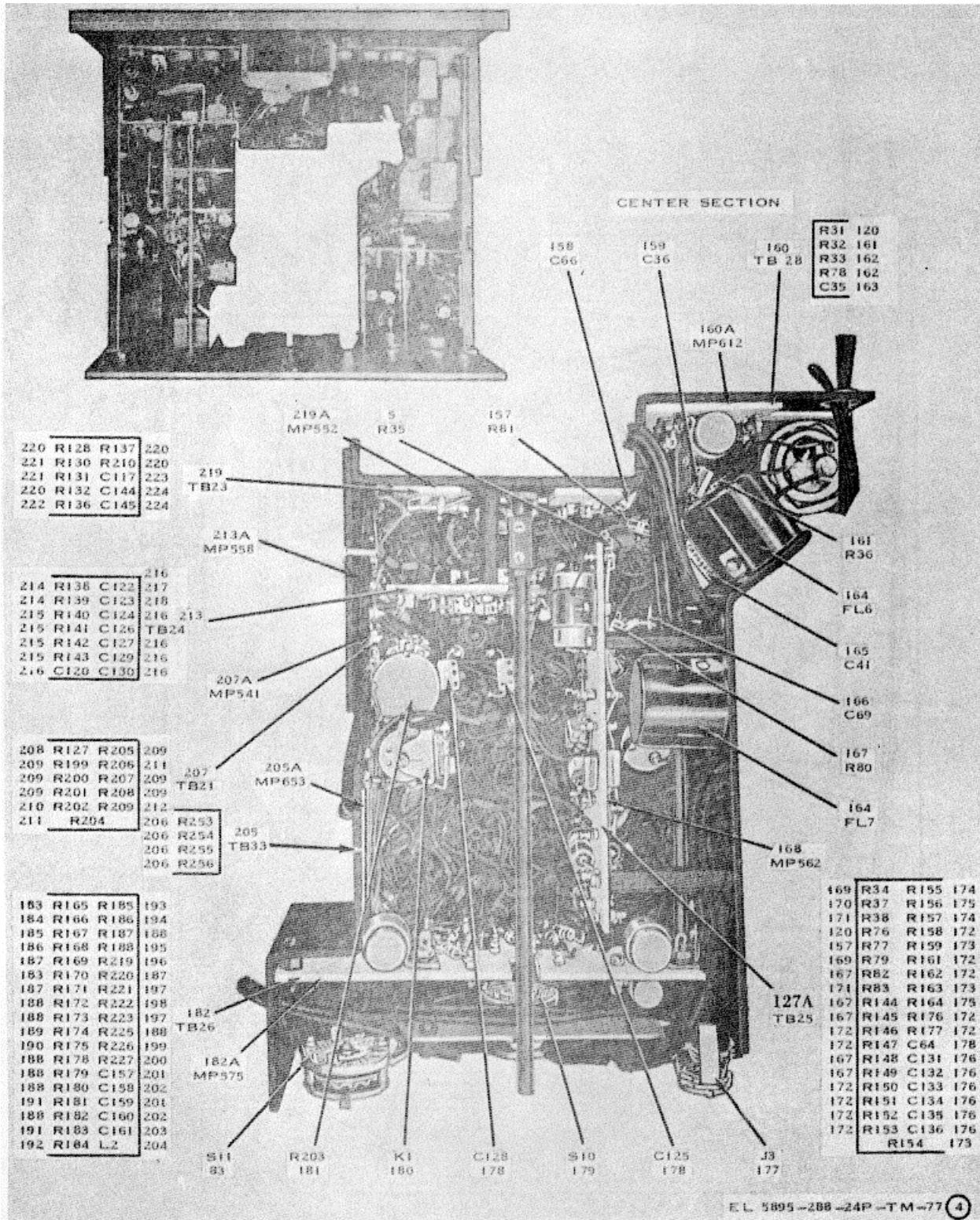
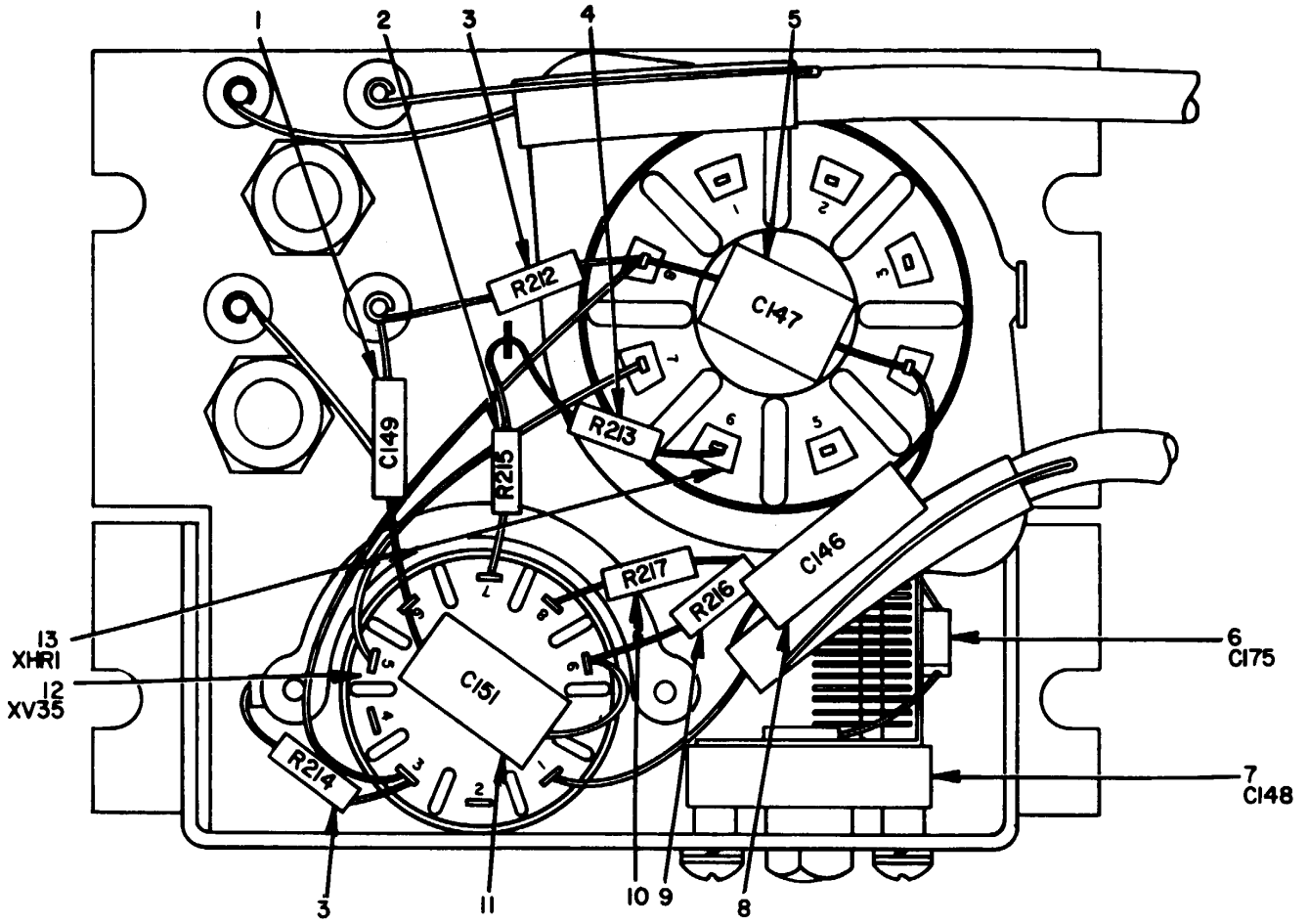

Figure 77. Converter Drawer Assembly, Bottom View (Sheet 4 of 4)

SECTION II. REPAIR PARTS LIST



EL5895-288-24P-TM-78

Figure 78. Oscillator Section, Bottom view

SECTION II. REPAIR PARTS LIST

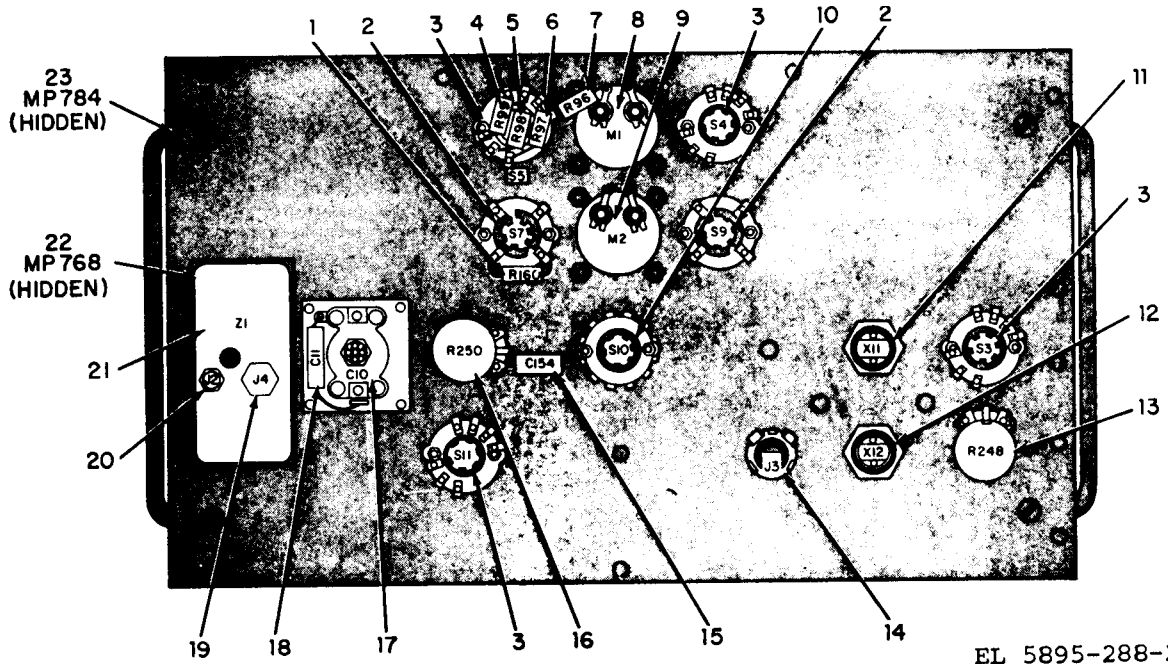

EL 5895-288-24P-TM-79

Figure 79. Control Panel, Rear View

SECTION II. REPAIR PARTS LIST

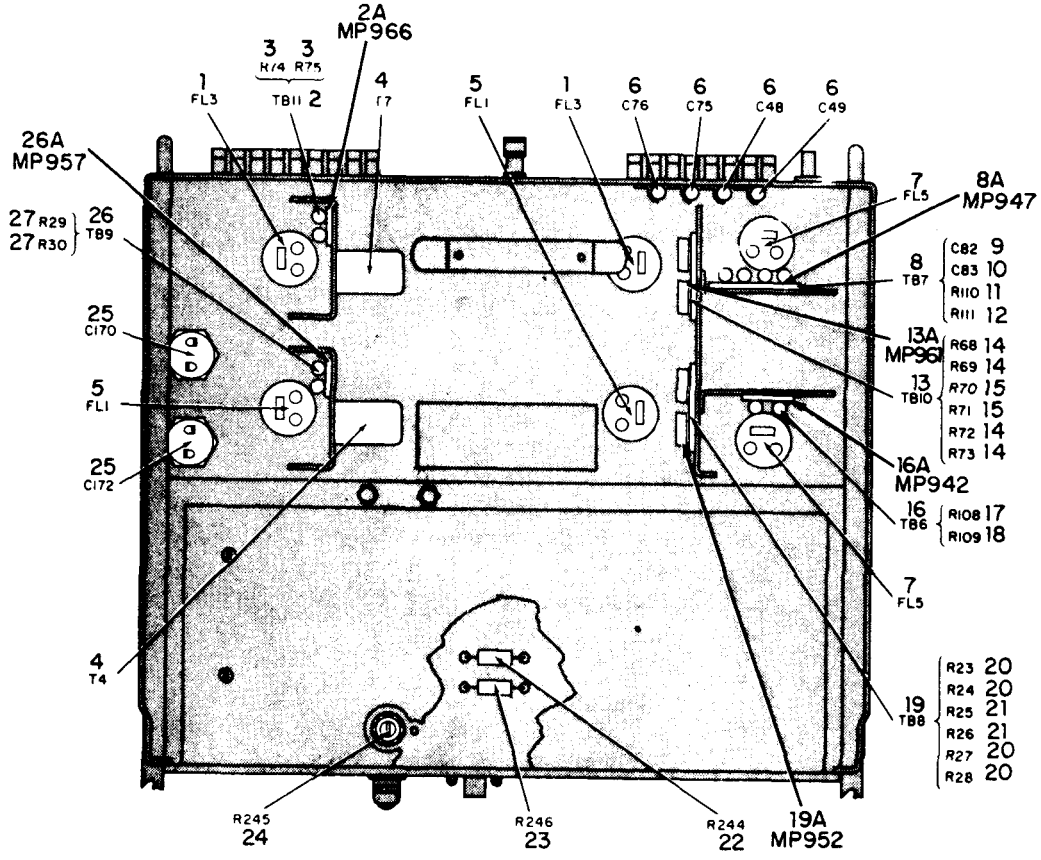

EL 5895-288-24P-TM-80

Figure 80. Converter Base Assembly, Top View

SECTION II. REPAIR PARTS LIST

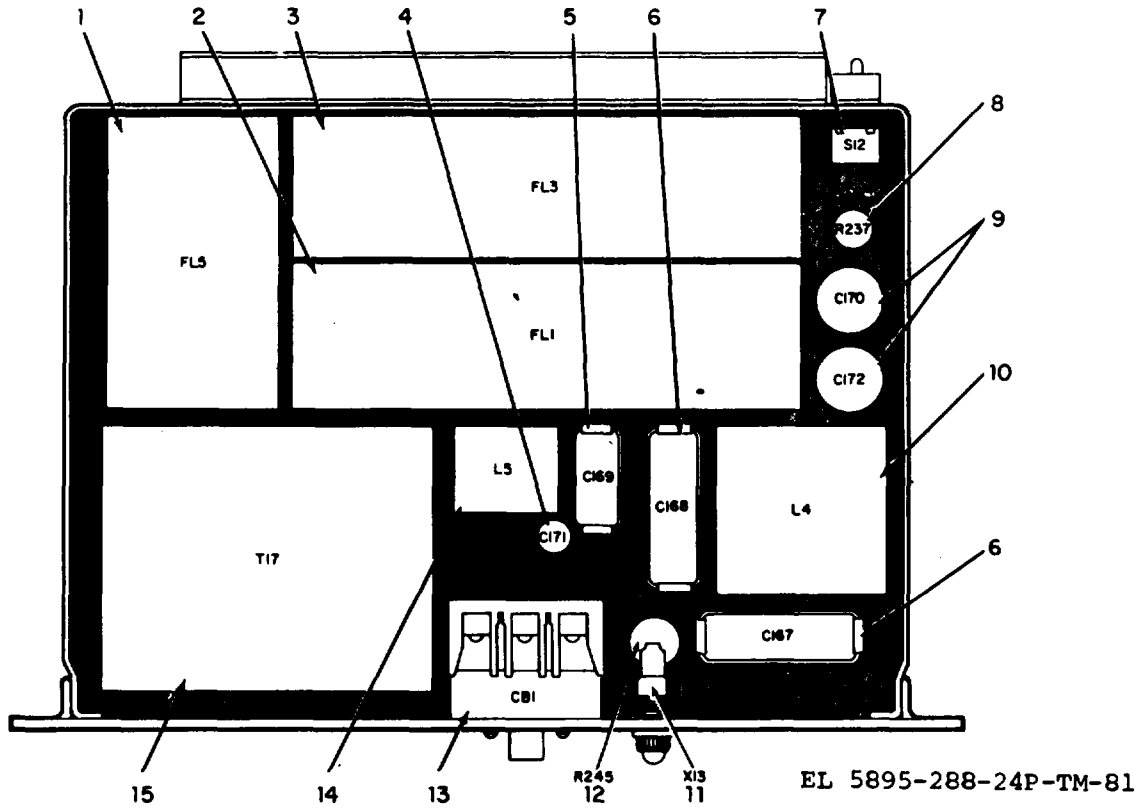
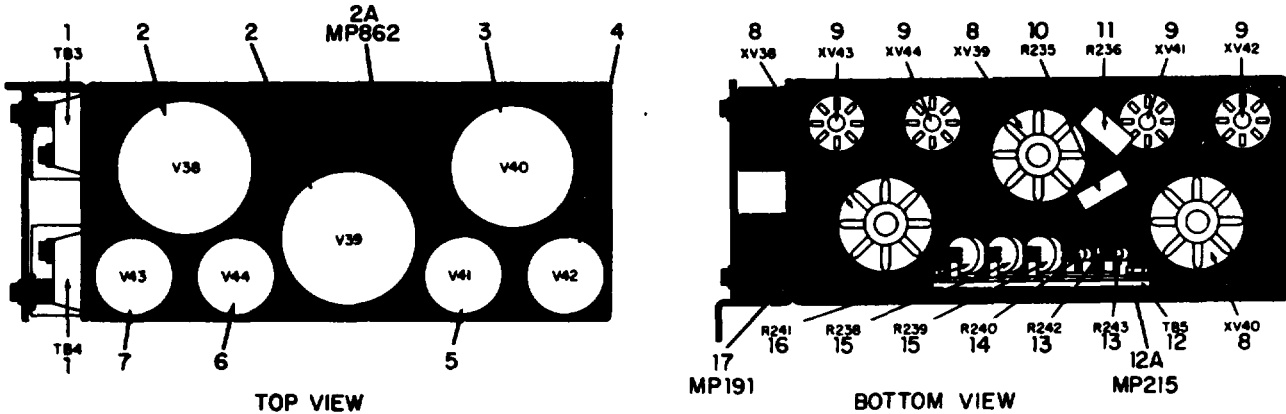

Figure 81. Converter Base Assembly, Bottom View

SECTION II. REPAIR PARTS LIST



EL 5895-288-24P-TM-82

Figure 82. Power Supply Tube Chassis

SECTION II. REPAIR PARTS LIST

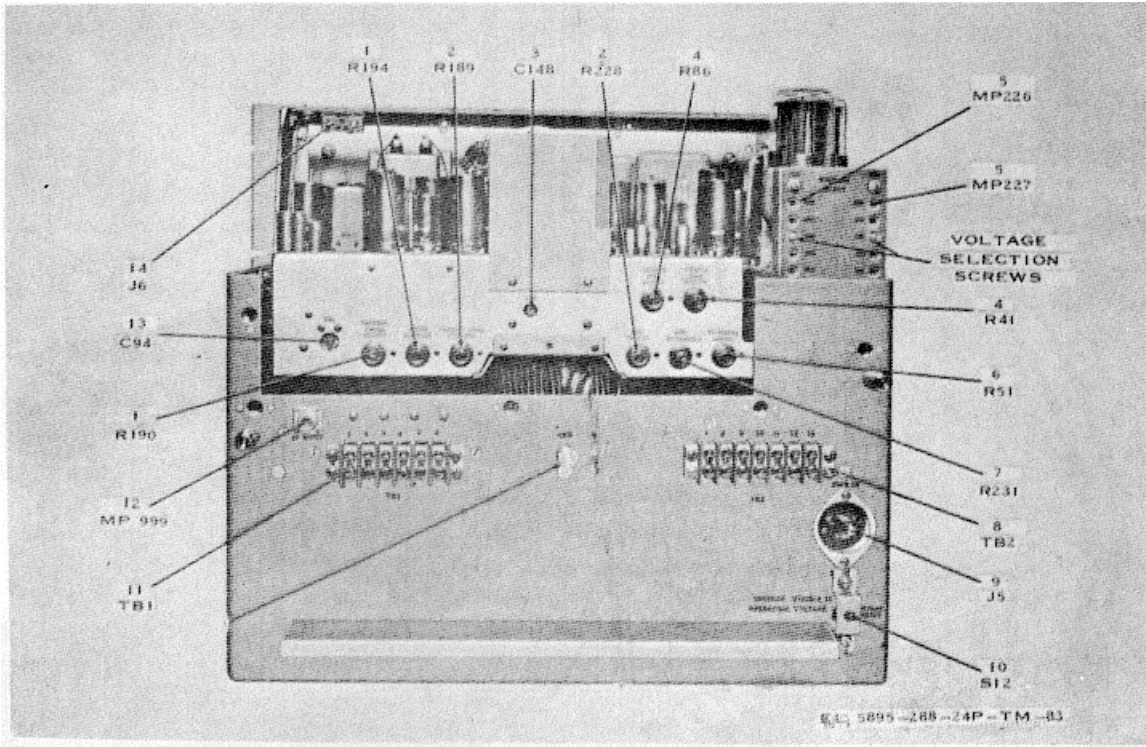

Figure 83. Converter, Rear View, Dust Cover Removed

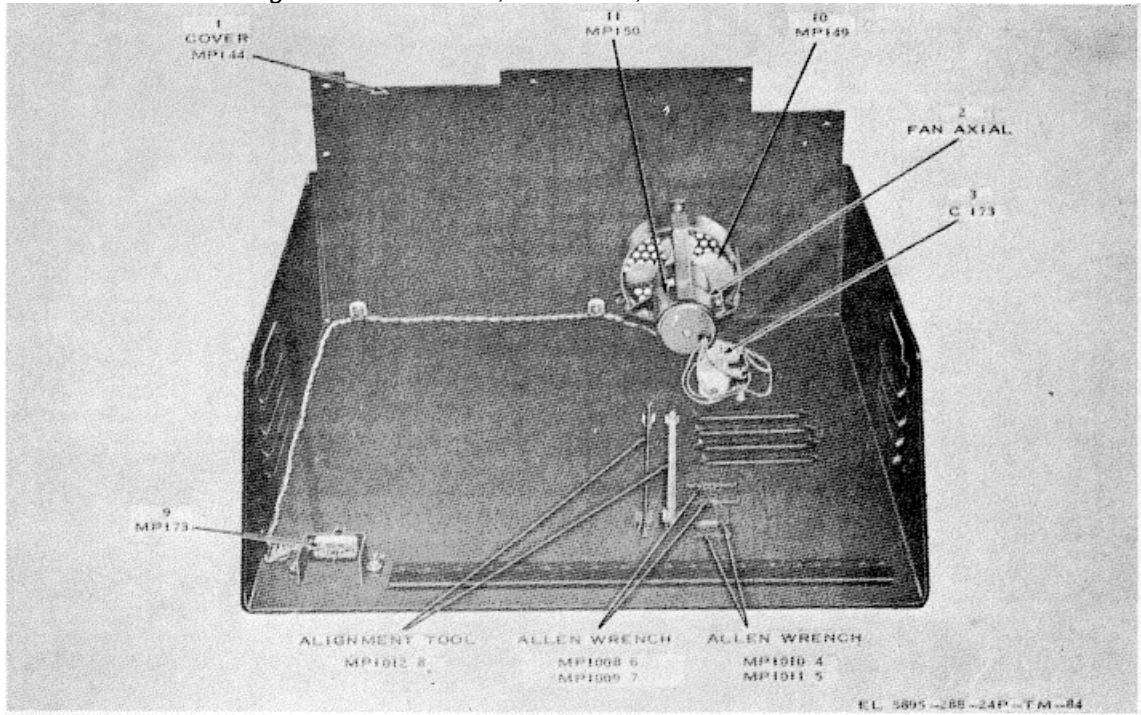
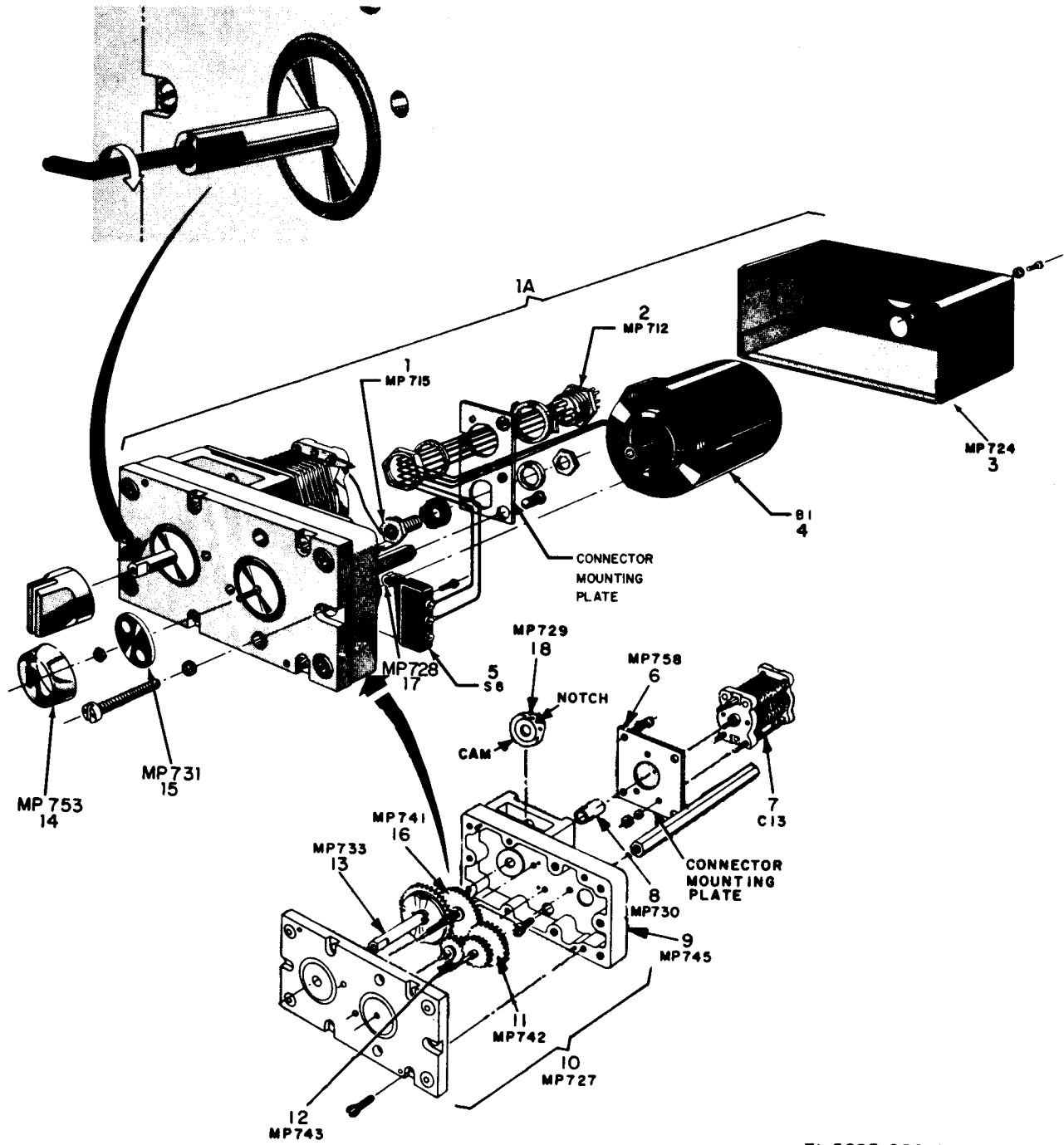

Figure 84. Interior of Converter Dust Cover

SECTION II. REPAIR PARTS LIST



EL 5895-288-24P-TM-85

Figure 85. AFC Unit, Exploded View

SECTION II. REPAIR PARTS LIST

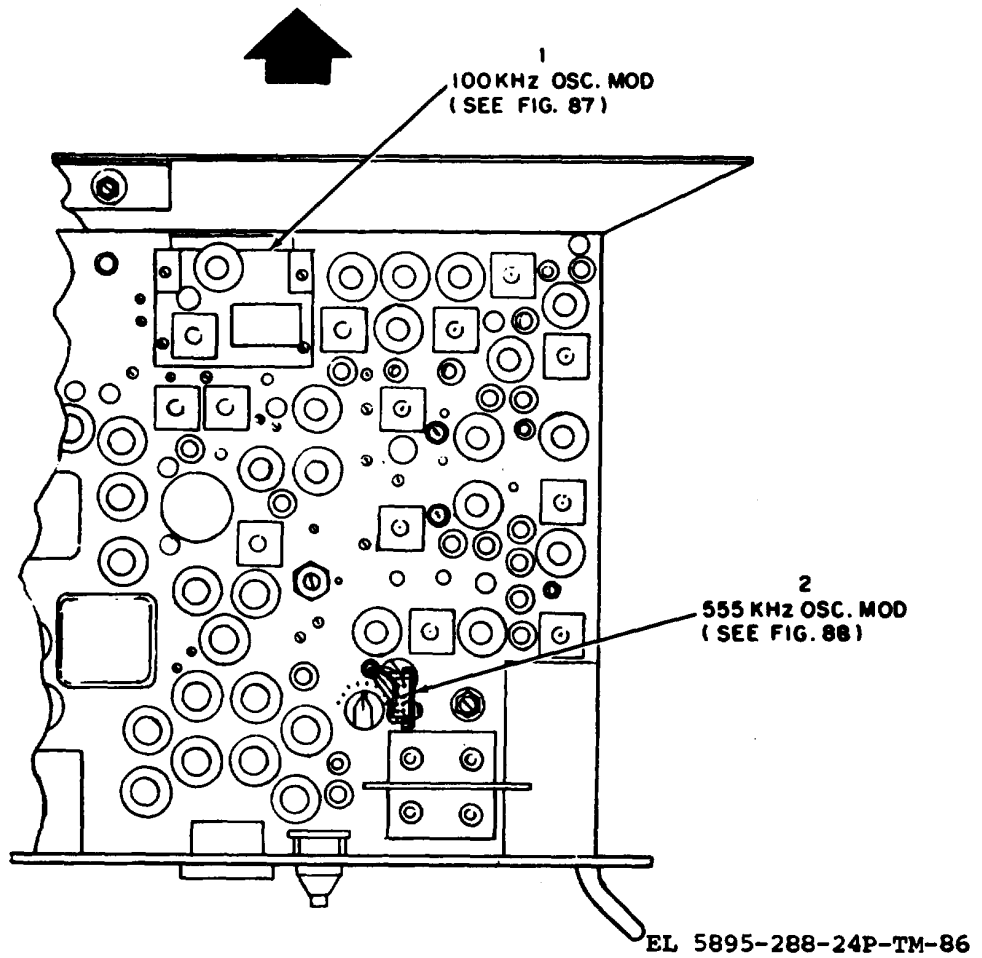
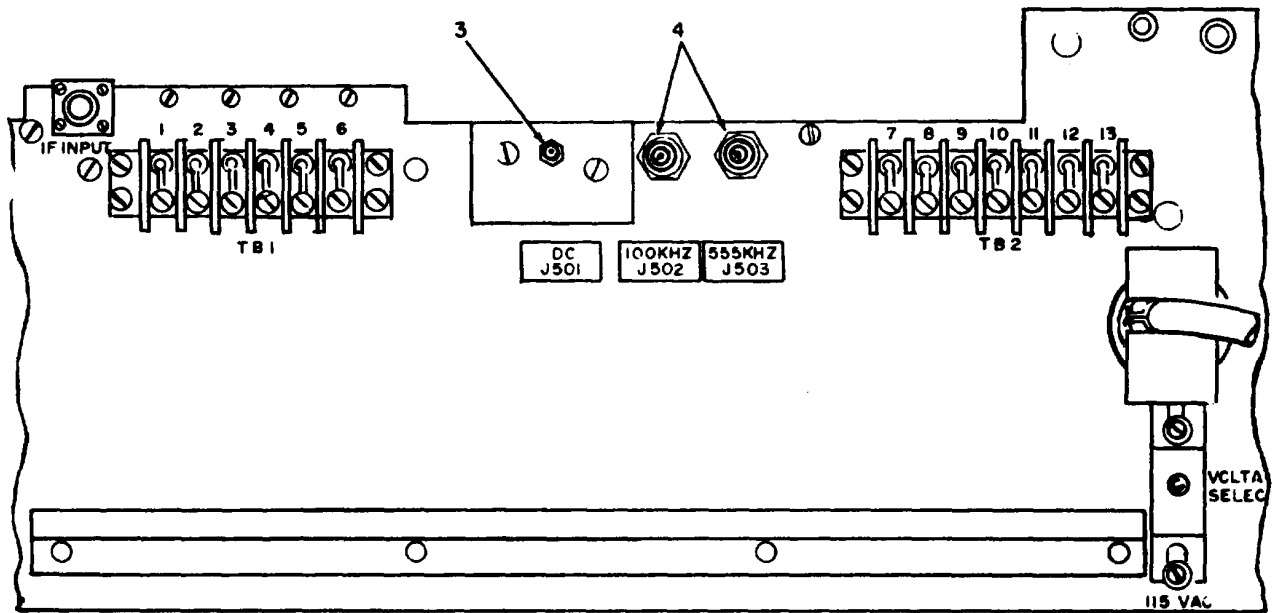
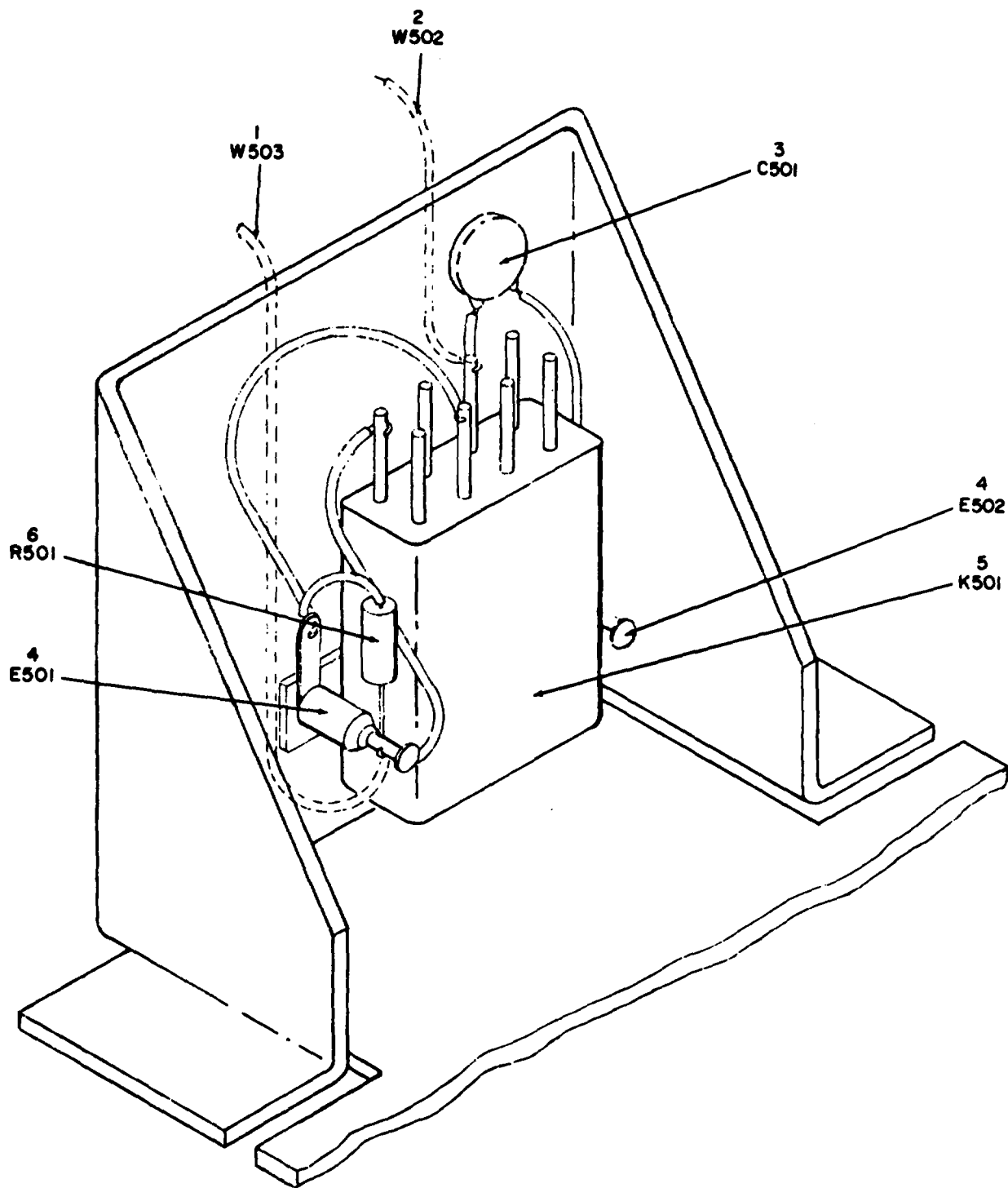

Figure 86. Converter Top and Rear View, Modification



EL 5895-288-24P-TM-8

Figure 87. 100 XHz Oscillator Modification

SECTION II. REPAIR PARTS LIST

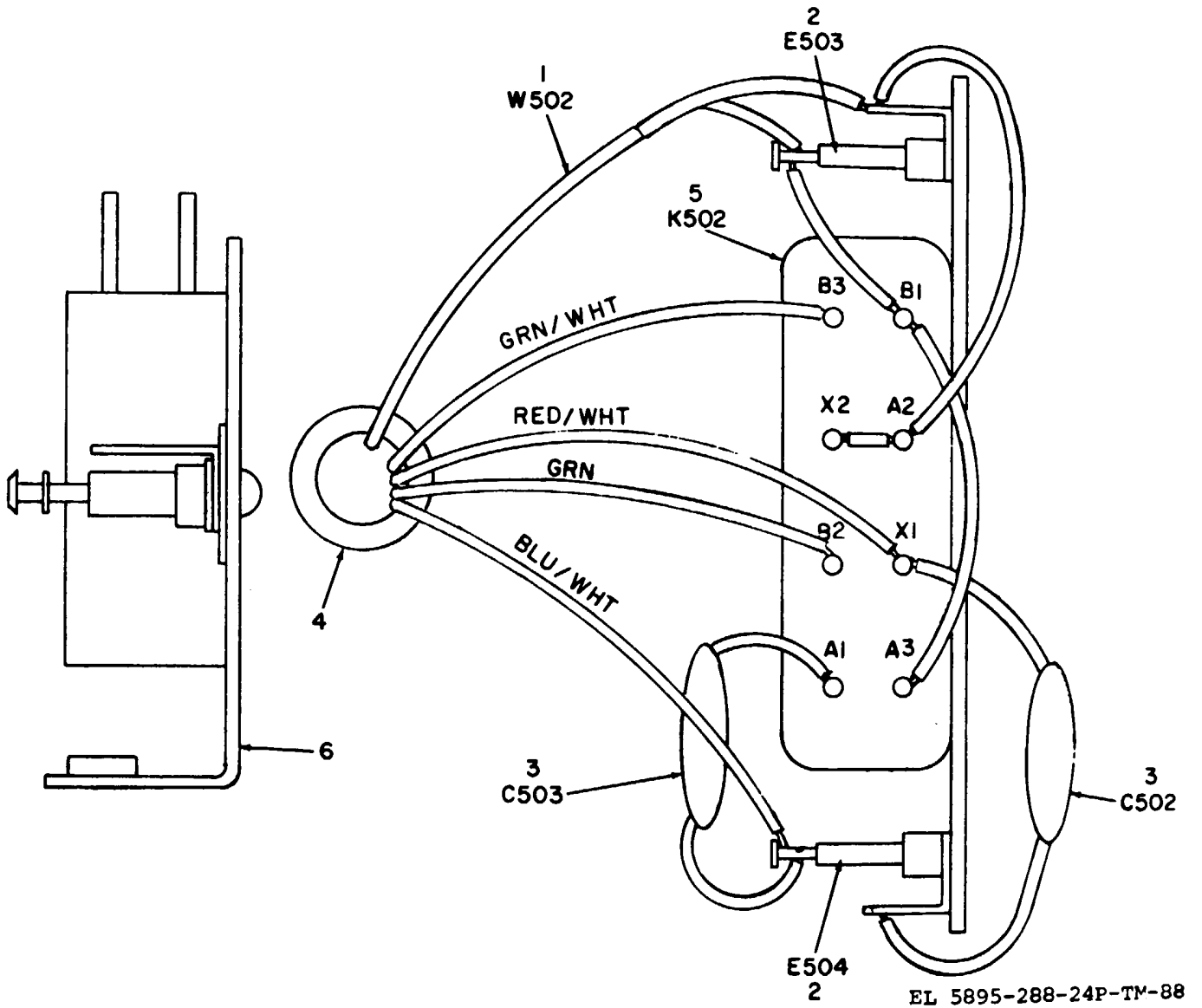
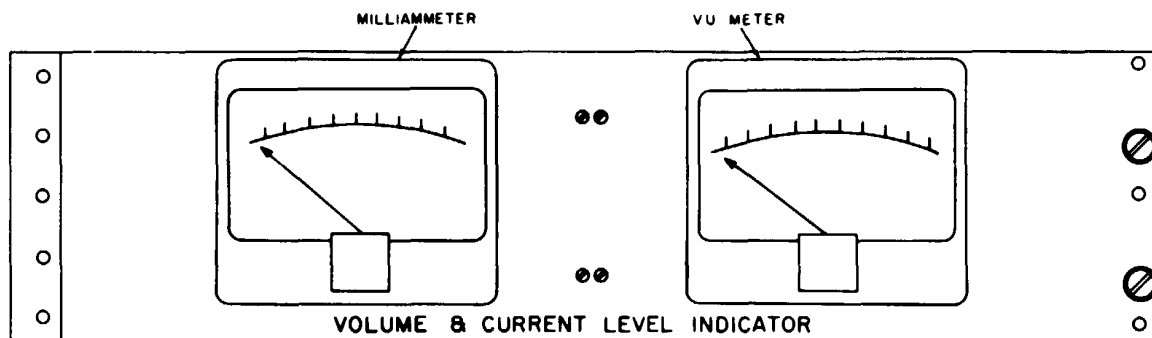
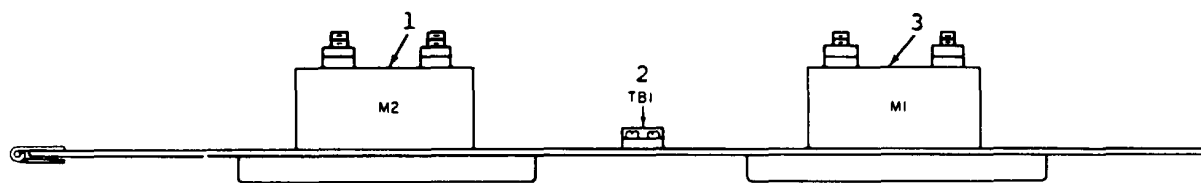

Figure 88. 555 KHz Oscillator Modification

SECTION II. REPAIR PARTS LIST



EL 5895-288-24P-TM-89

Figure 89. Volume and Current Level Indicator Panel
254

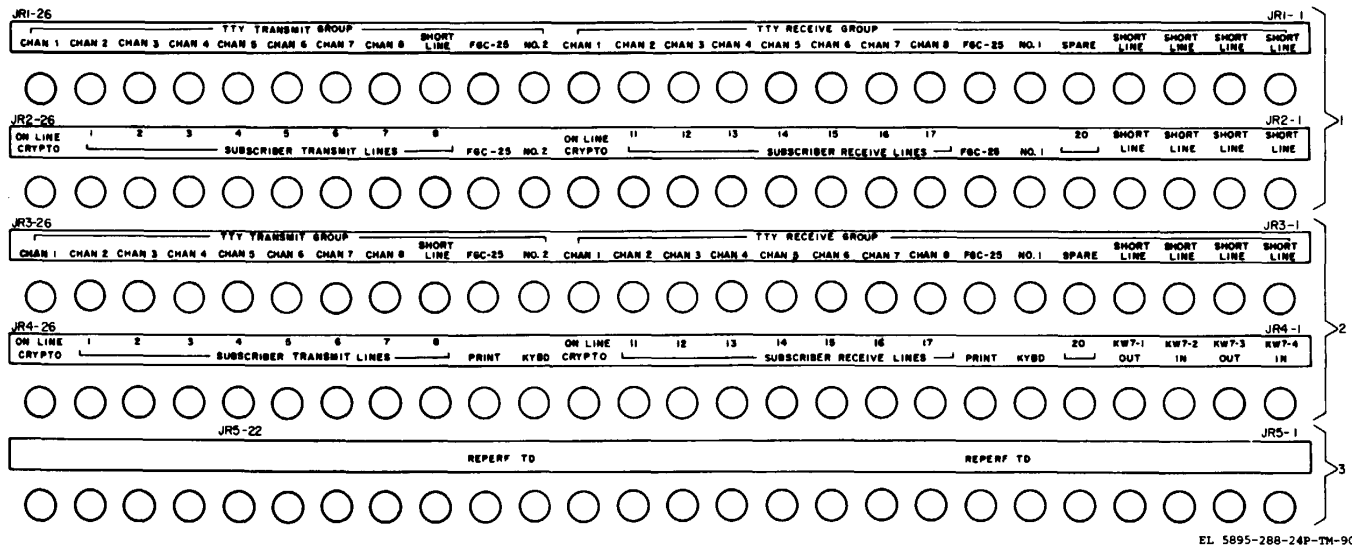

Figure 90. Black Patch Panel

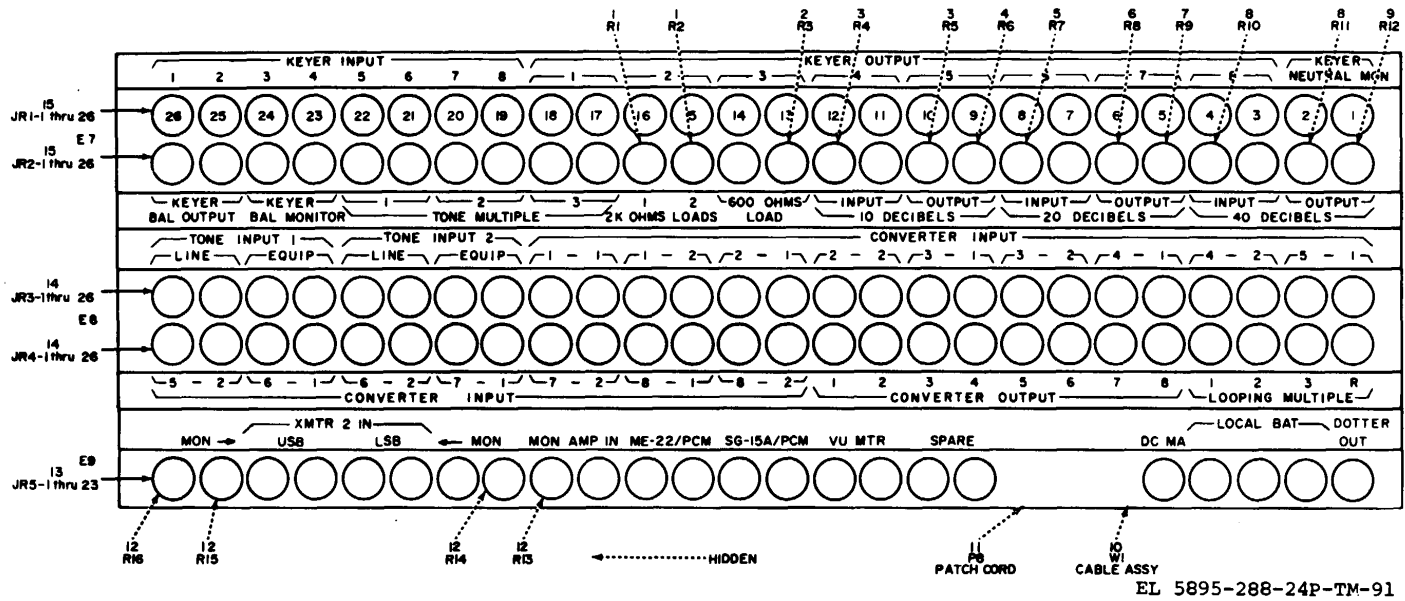

Figure 91. Audio-DC Patch Panel

SECTION II. REPAIR PARTS LIST

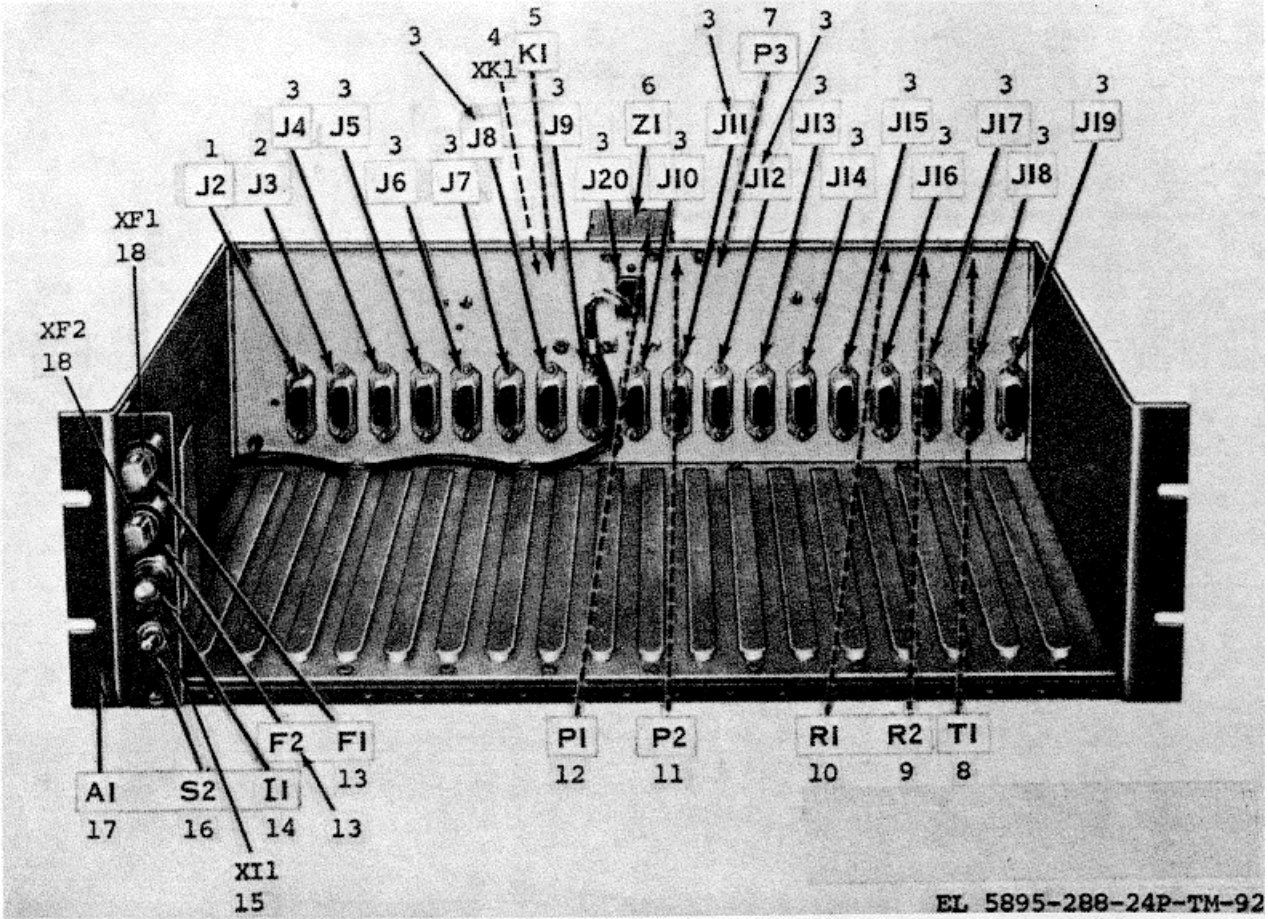

Figure 92. Tone Keyer Shelf, Type 221, Model 1

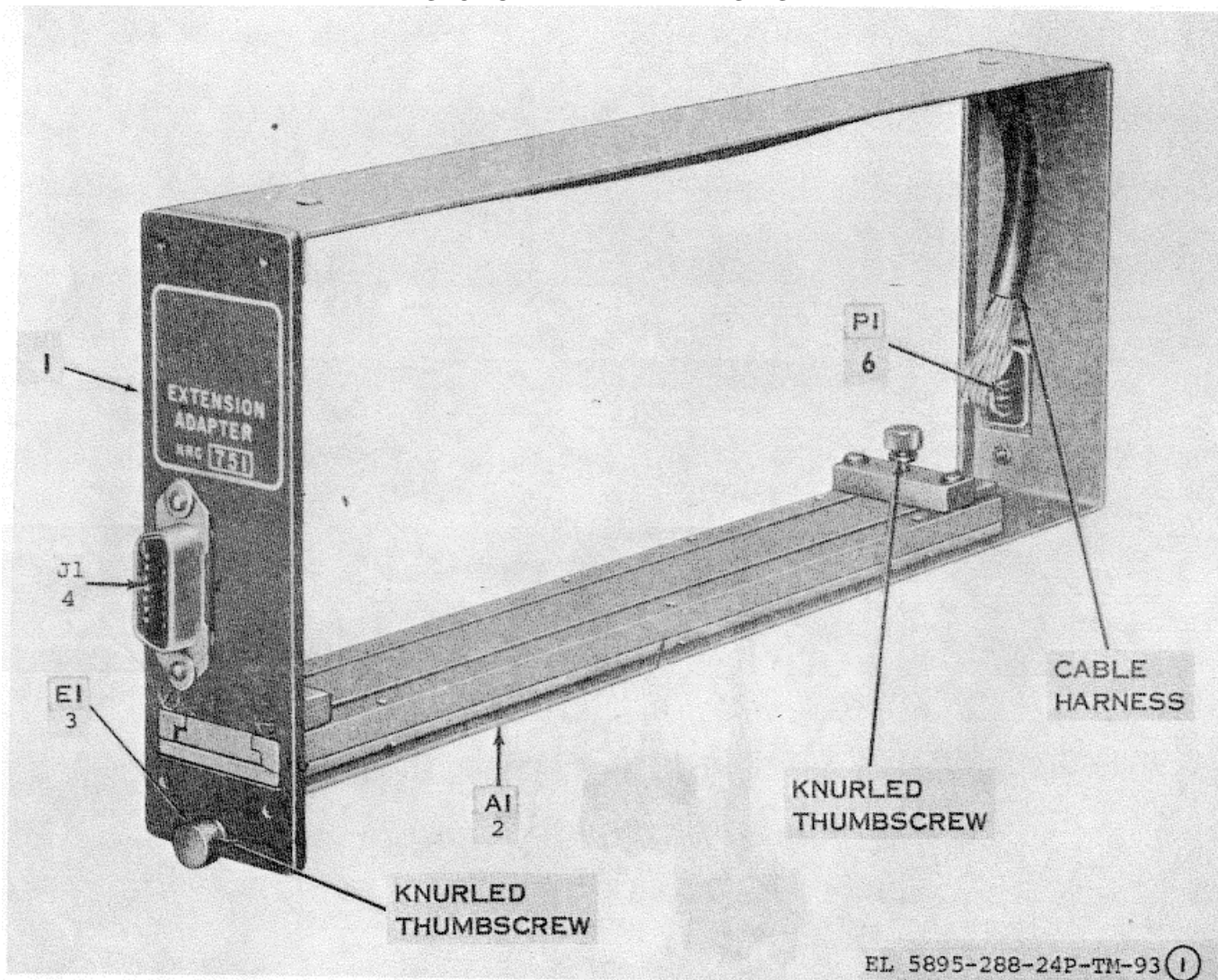

Figure 93. Extension Adapter AI, Models 750 and 751 (Sheet 1 of 2)

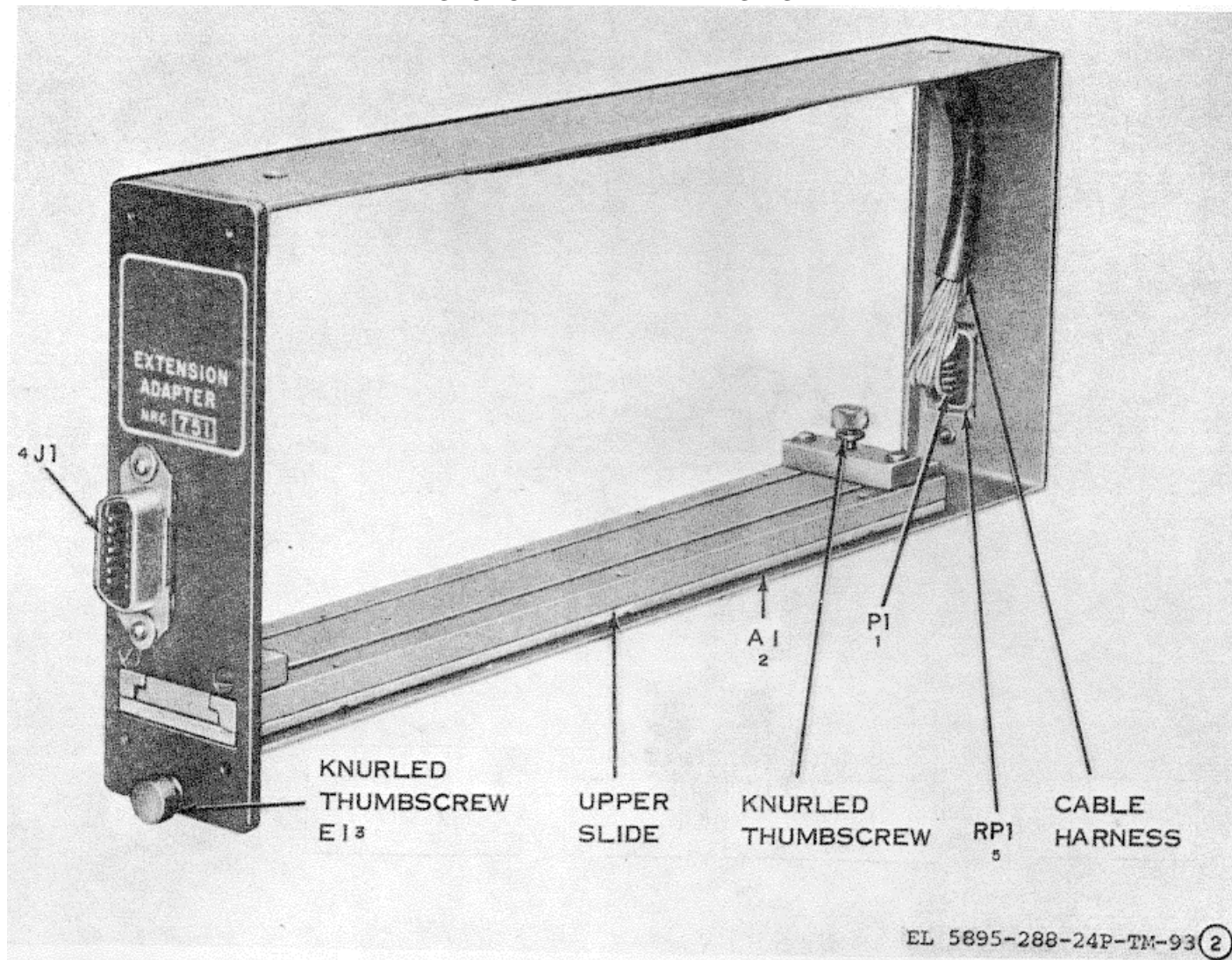

Figure 93. Extension Adapter A1, Models 750 and 751 (Sheet 2 of 2)

SECTION II. REPAIR PARTS LIST

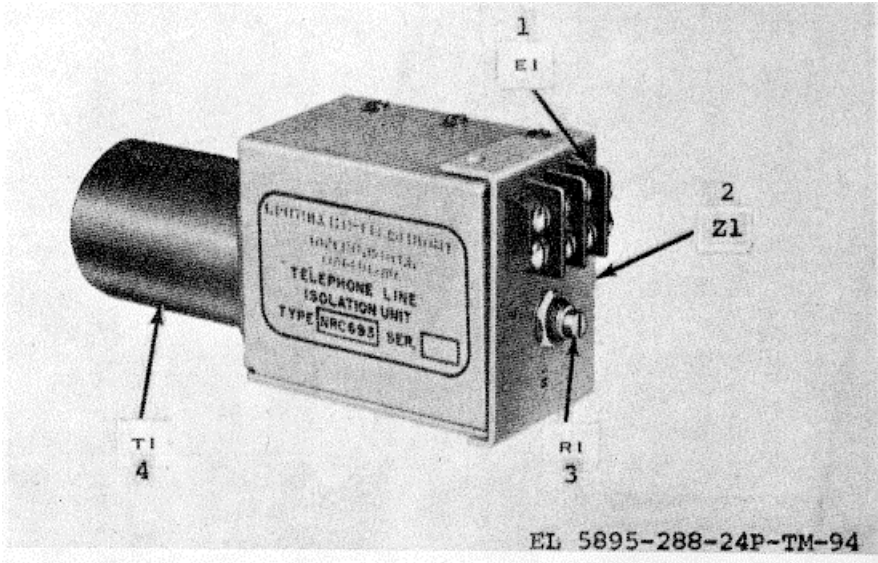

Figure 94. Telephone Line Isolation Unit Z1

SECTION II. REPAIR PARTS LIST

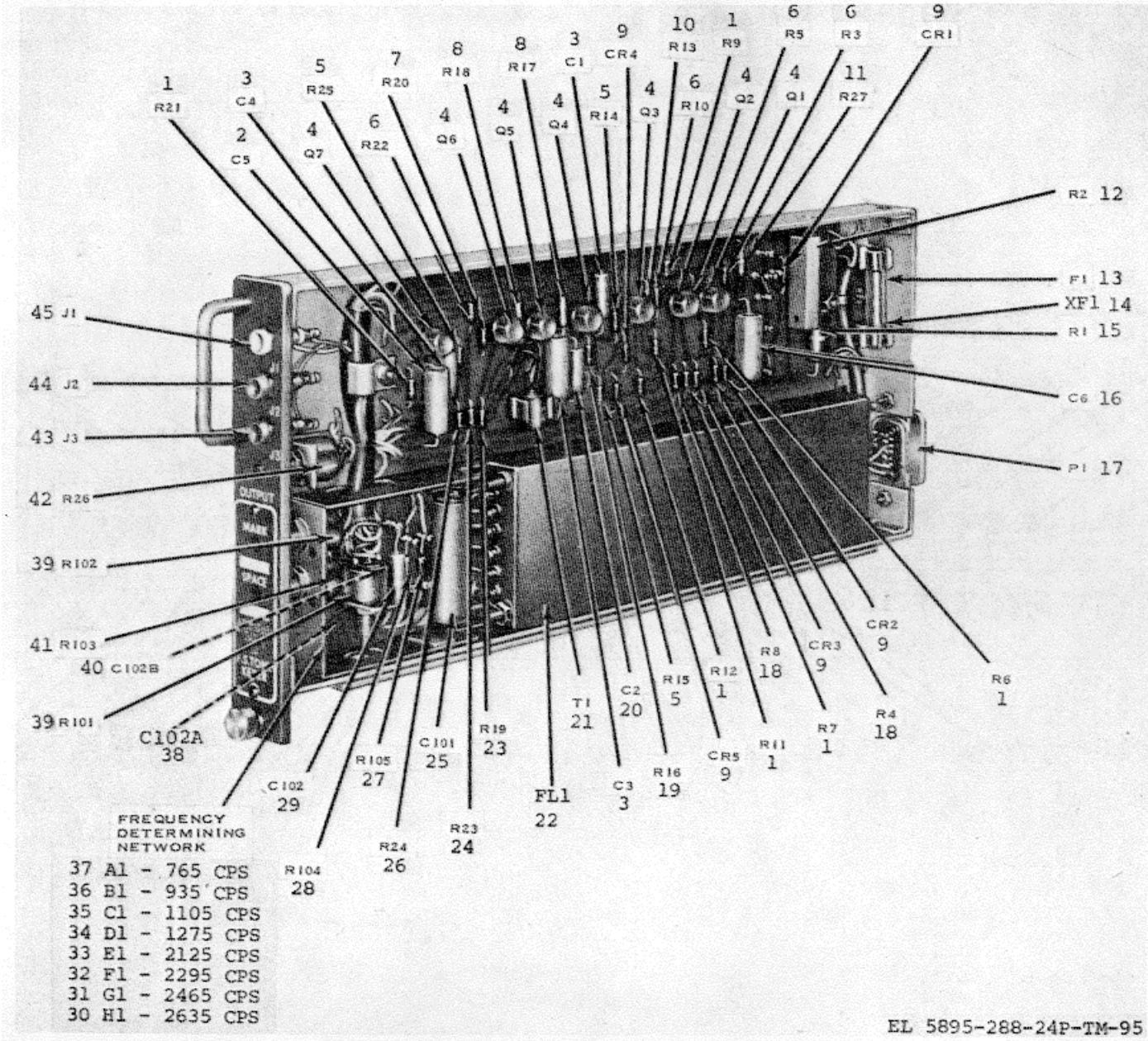
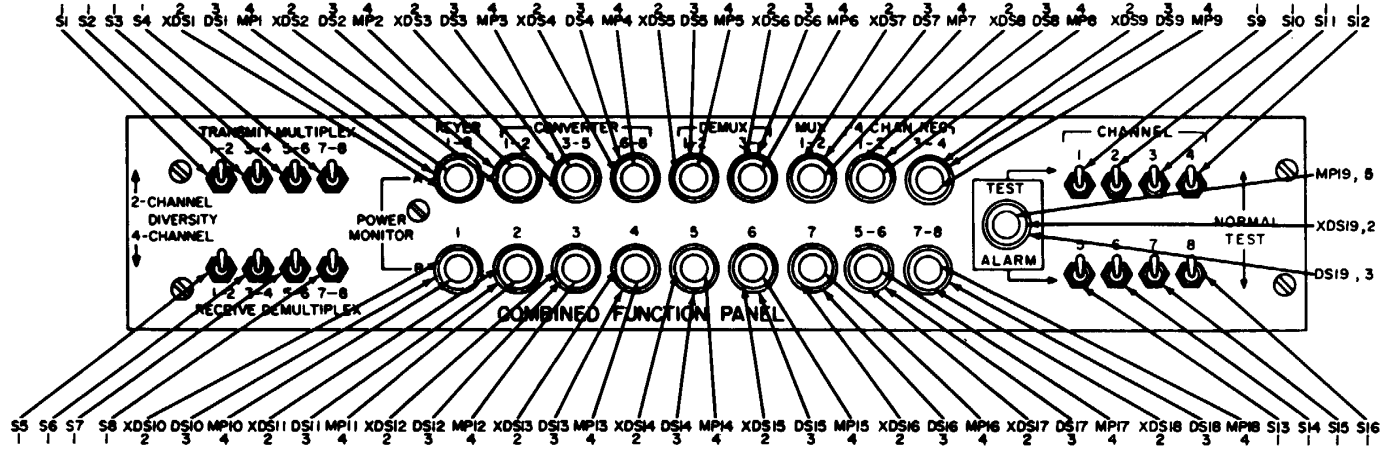

Figure 95. Frequency Shift Tone Keyer Type 211, Model 2



EL 5895-288-24P-TM-96 (1)

Figure 96. Combined Function Panel (Sheet 1 of 3)

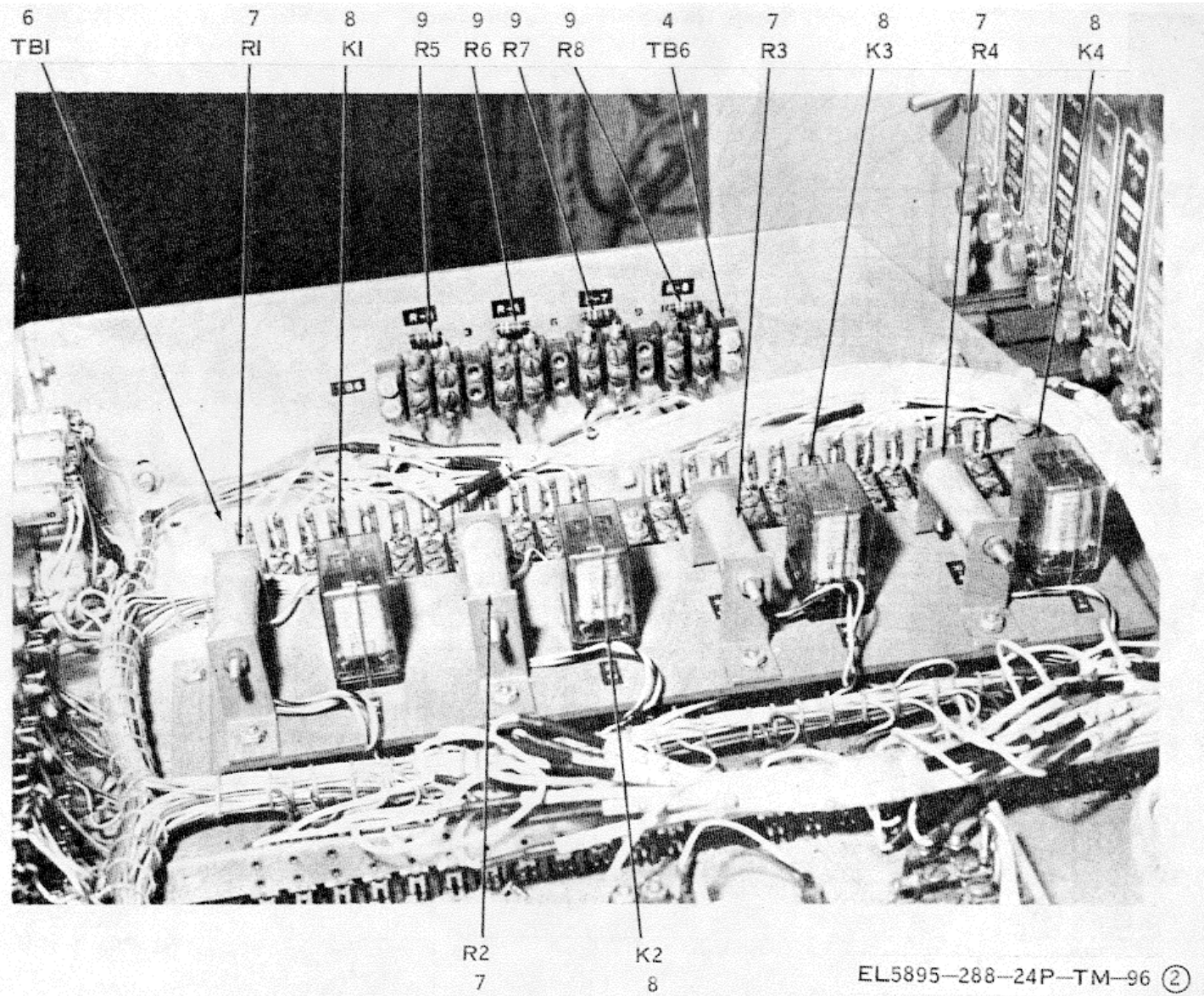

Figure 96. Combined Function Panel (Sheet 2 of 3)

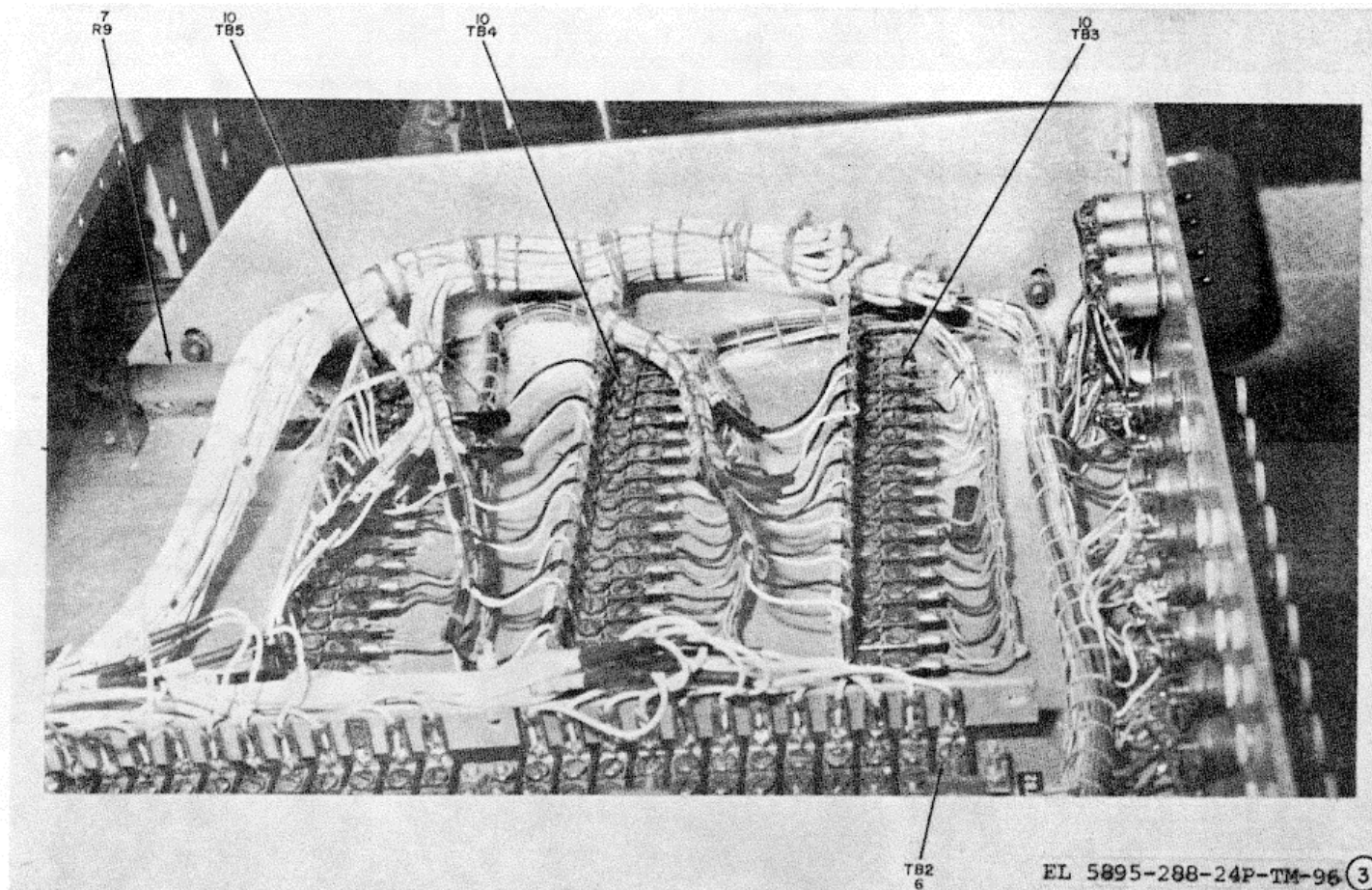
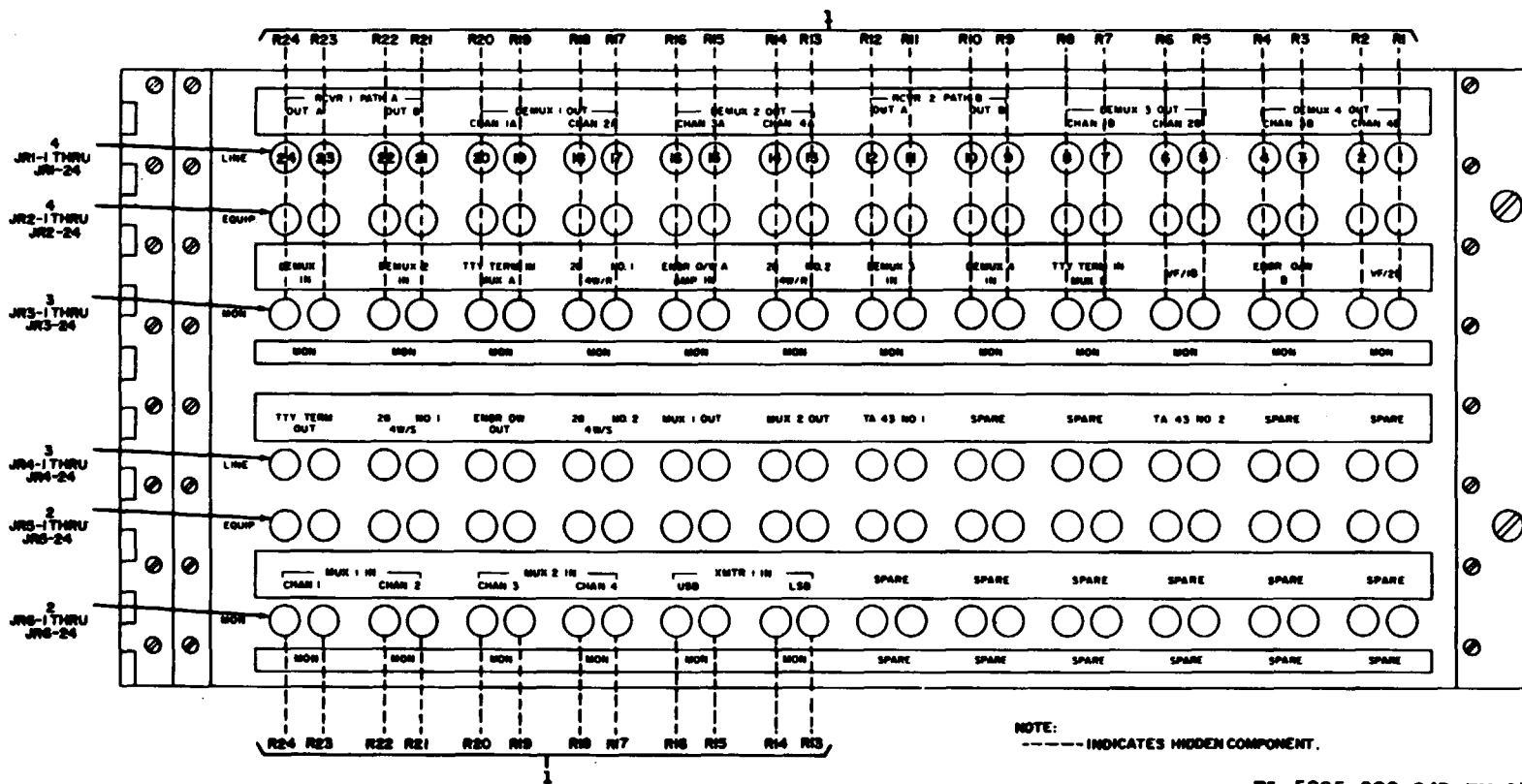

Figure 96. Combined Function Panel (Sheet 3 of 3)

Section II. REPAIR PARTS LIST



EL 5895-288-24P-TM-97

Figure 97. Audio Patch Panel

Section II REPAIR PARTS LIST

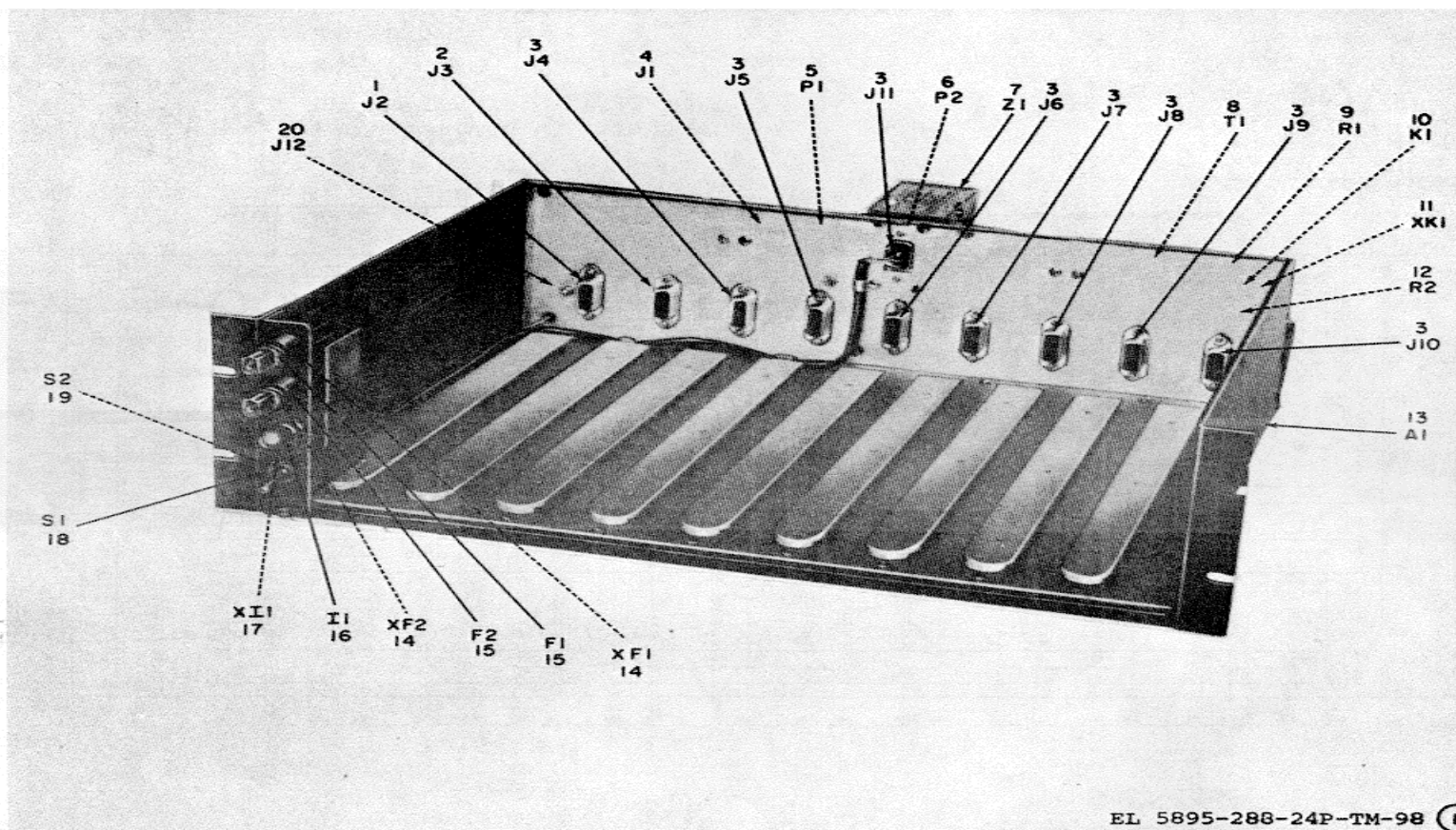

EL 5895-288-24P-TM-98 (1)

Figure 98. Tone Converter Shelf No. 1, Type 222, Model 5 (Sheet 1 of 2)

Section II REPAIR PARTS LIST

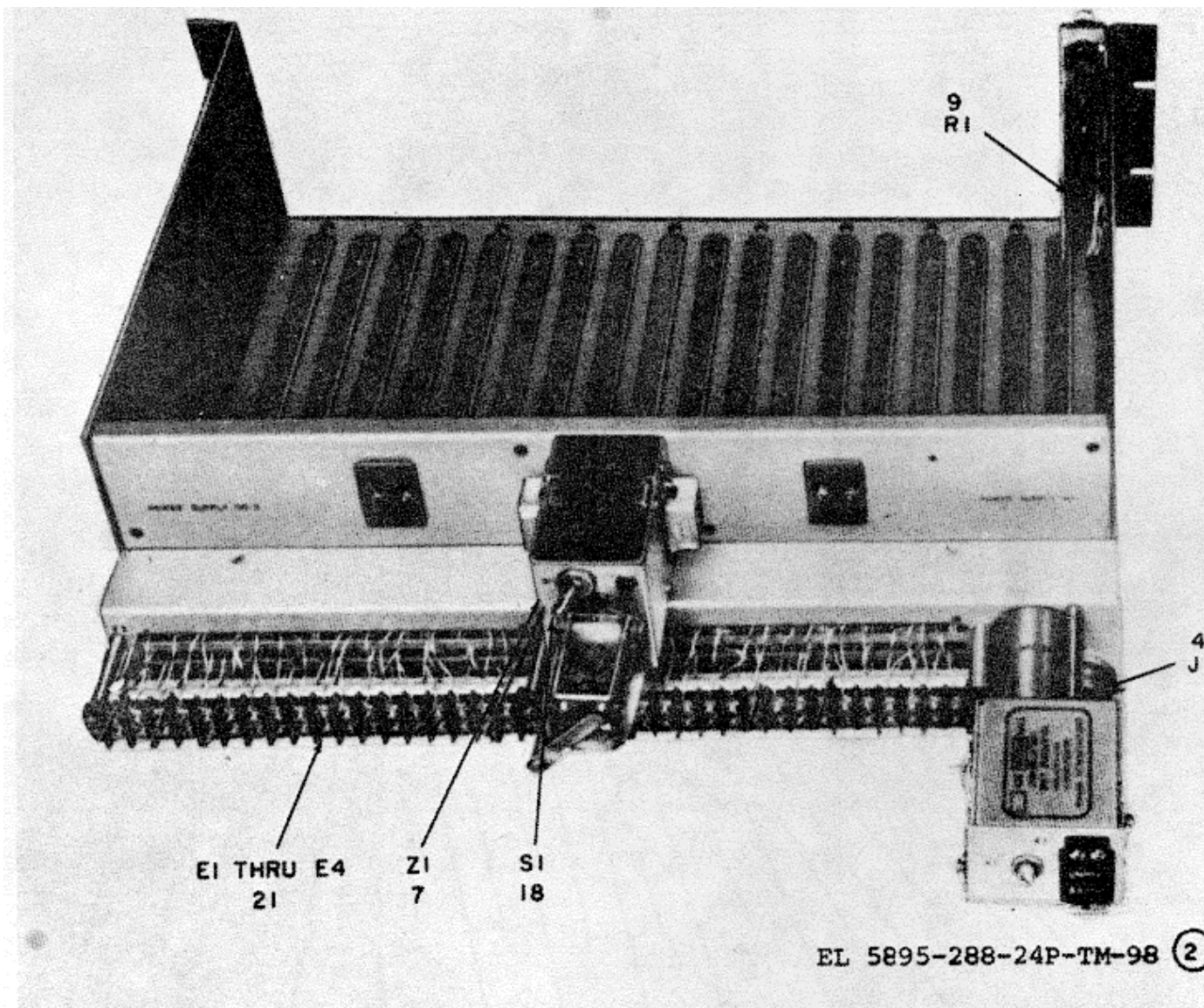
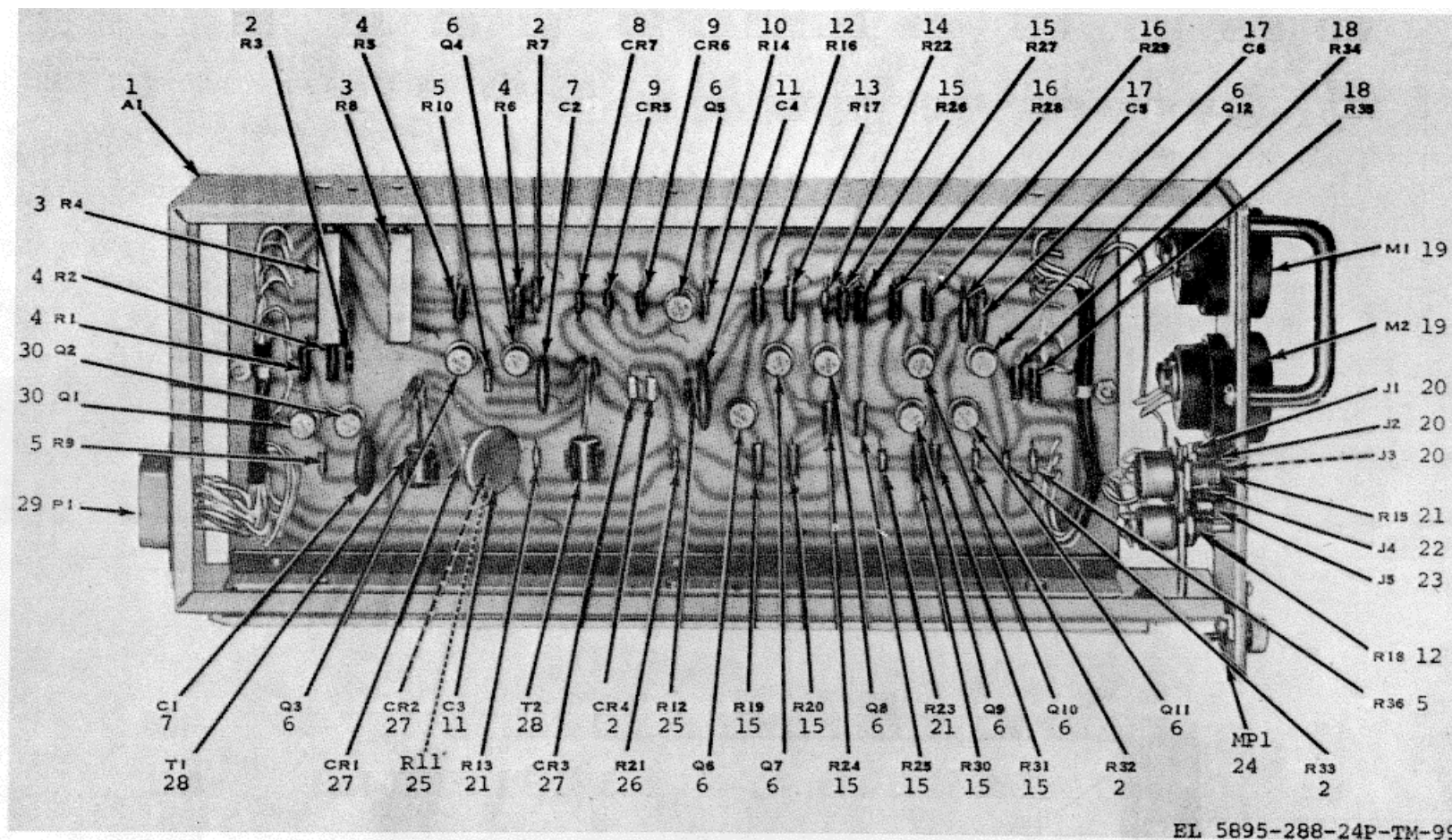

Figure 98. Tone Converter Shelf No. 1, Type 222, Model 5 (Sheet 2 of 2)
267

Section II REPAIR PARTS LIST



EL 5895-288-24P-TM-99

Figure 99. Diversity Combiner, Type 234, Model 2

Section II REPAIR PARTS LIST

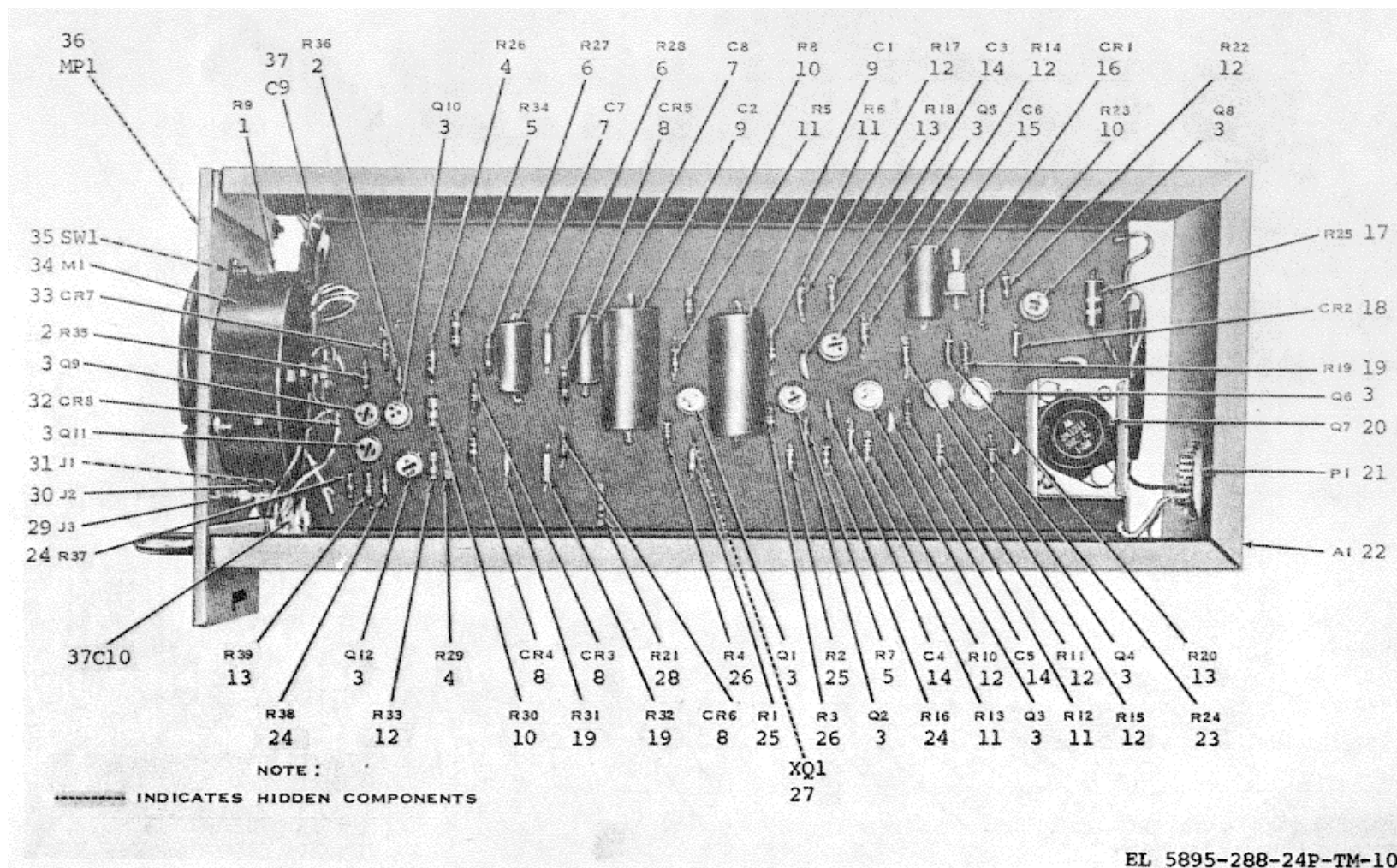

Figure 100. Dotter and Delay Indicator

Section II REPAIR PARTS LIST

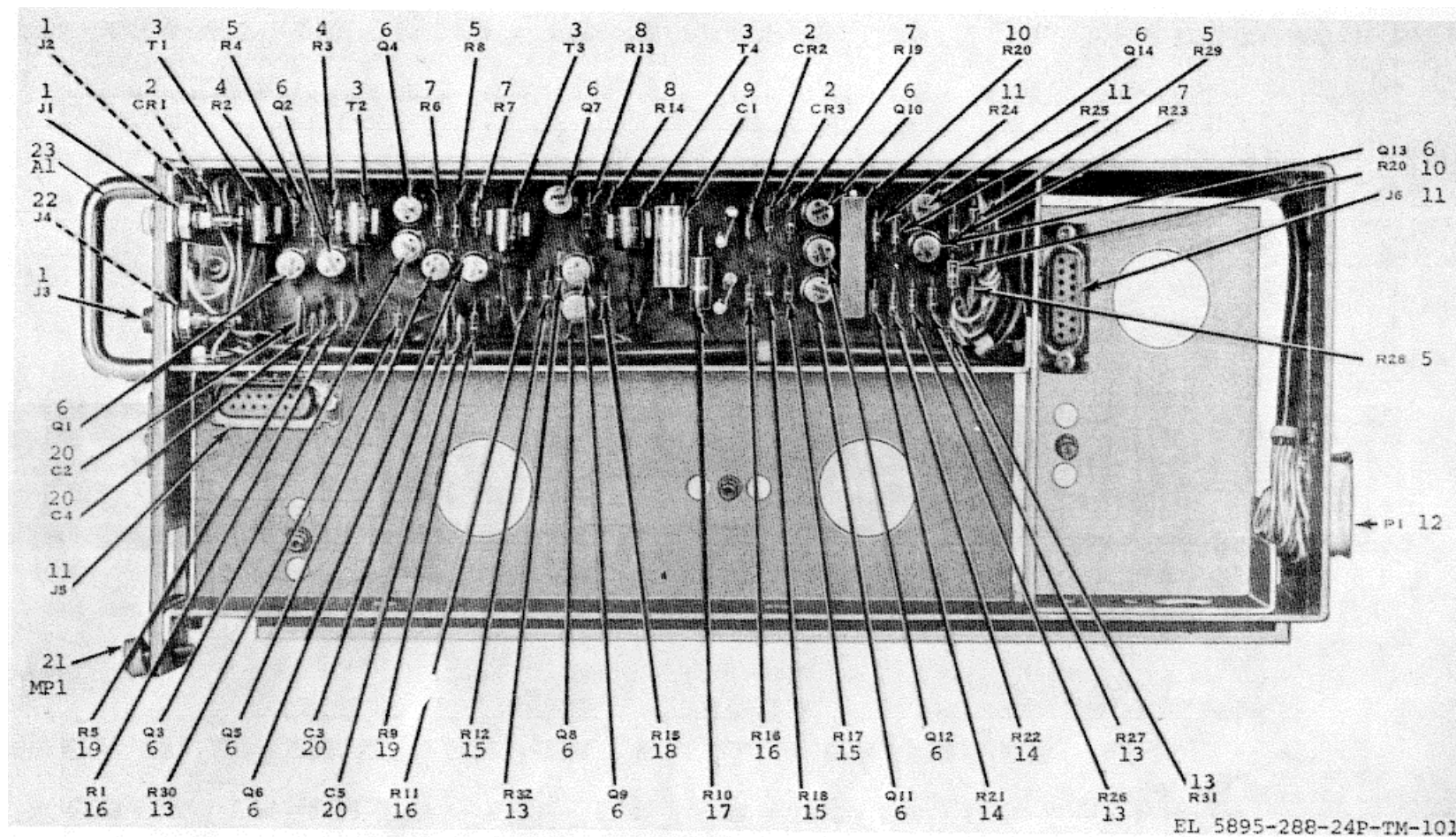

Figure 101. Frequency Shift Tone Converter, Type 212, Model 3

Section II REPAIR PARTS LIST

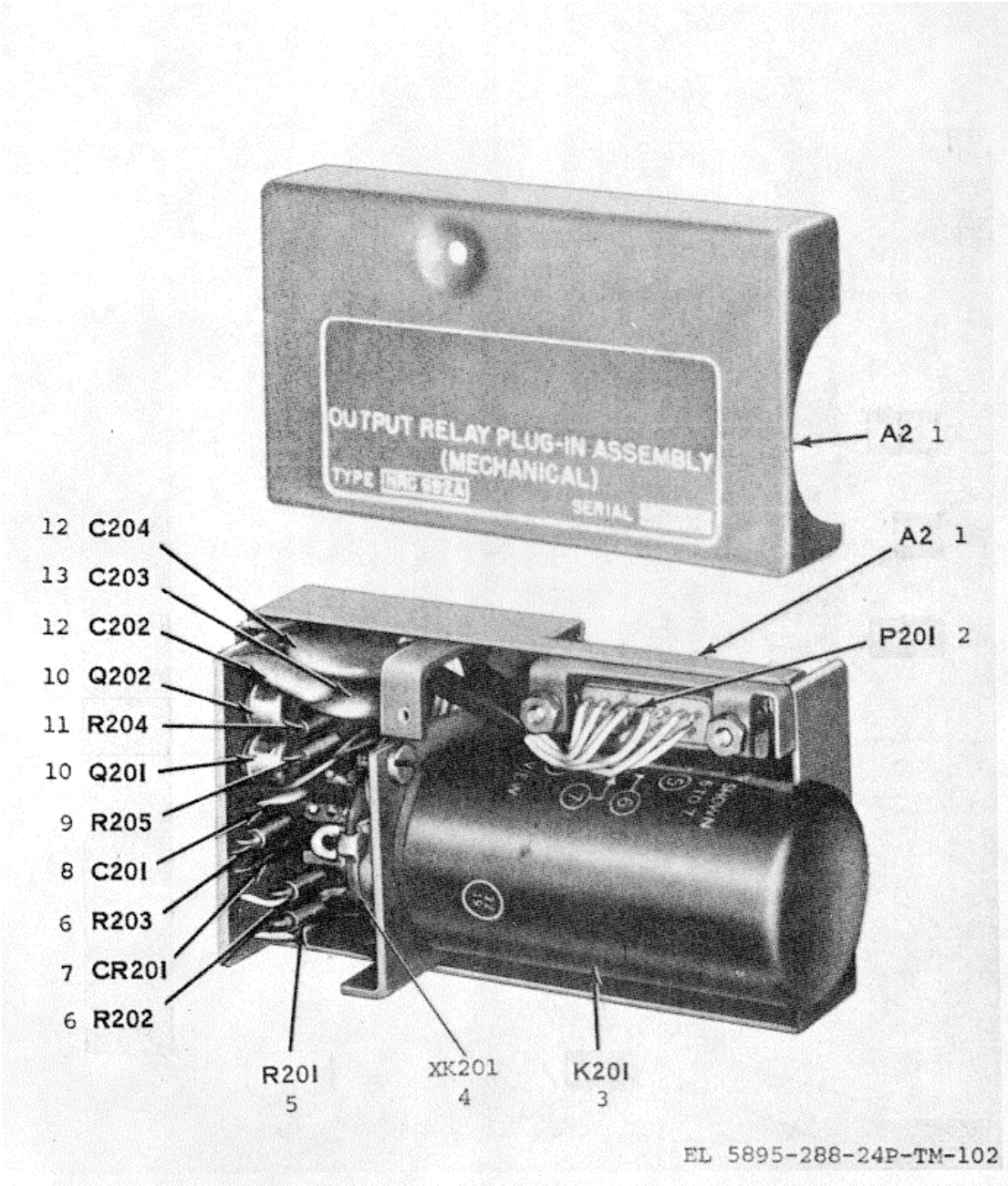

Figure 102. Relay Assembly, Type 692A

Section II REPAIR PARTS LIST

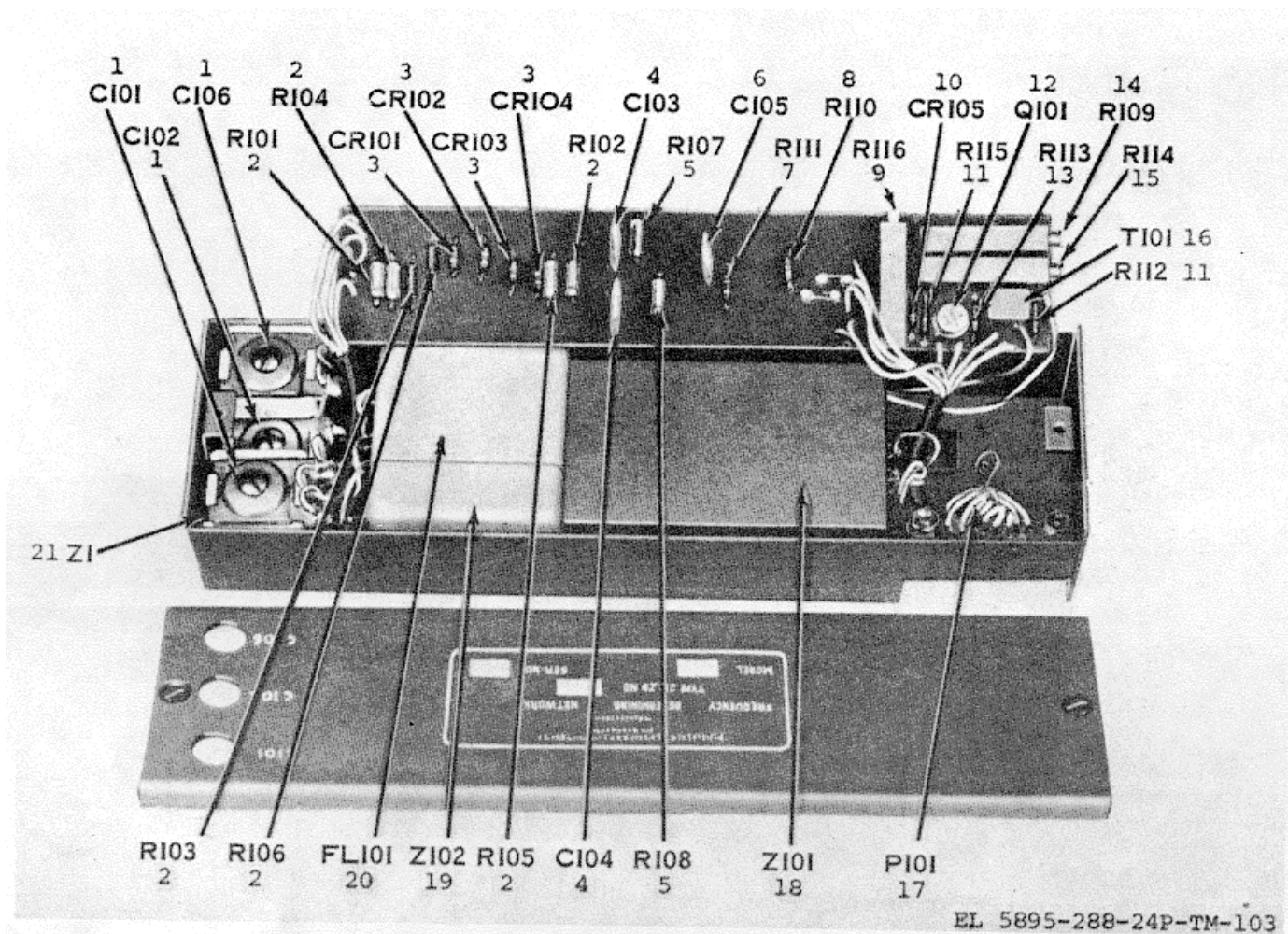

Figure 103. Frequency Determining and Delay Network, Type NRC 212-3ZD4, D12

Section II REPAIR PARTS LIST

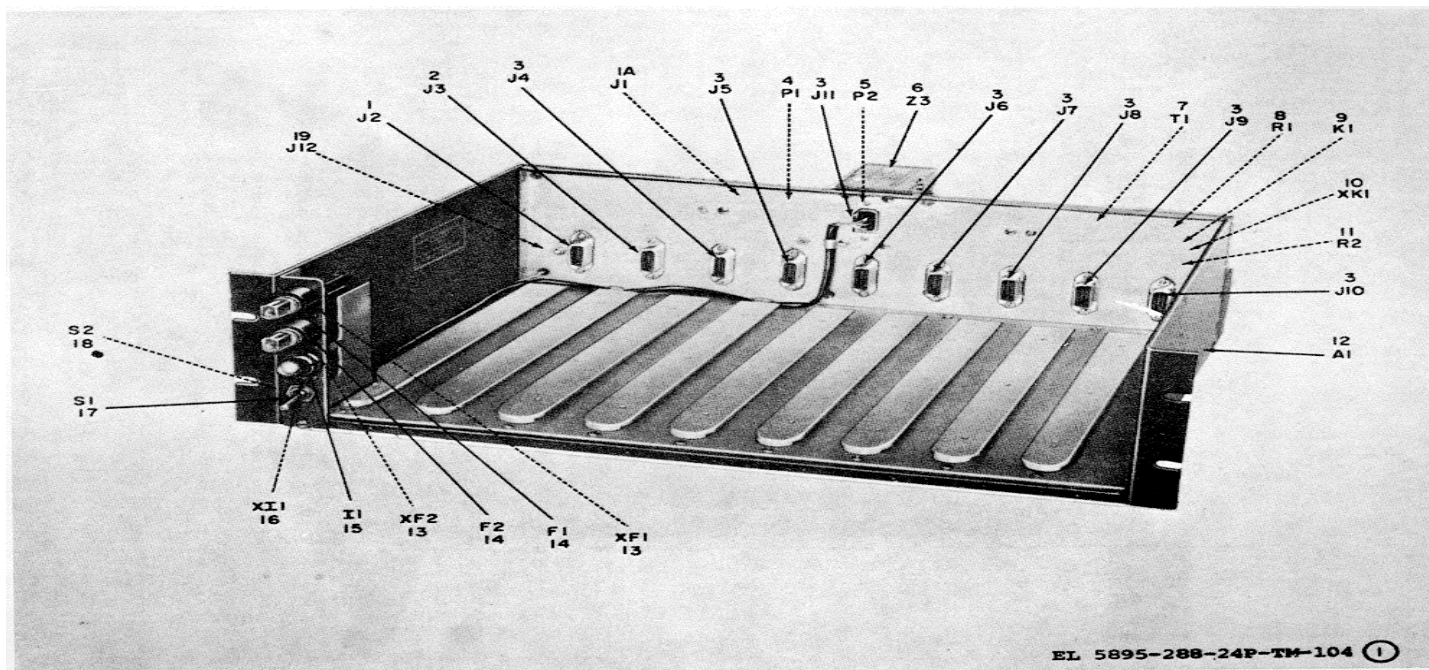

Figure 104. Tone Converter Shelves No. 1 and No. 3, Type 222, Model 4 (Sheet 1 of 2)

Section II REPAIR PARTS LIST

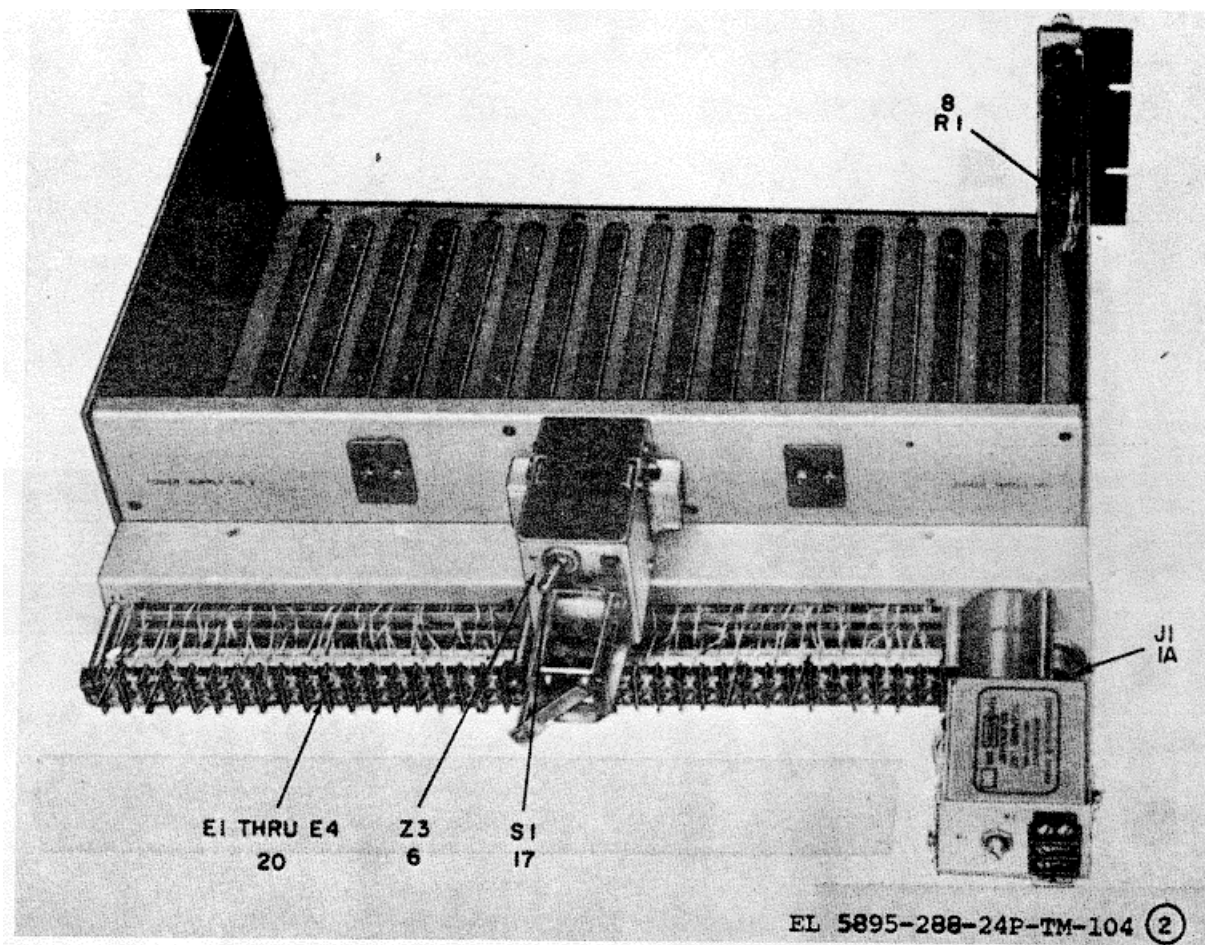
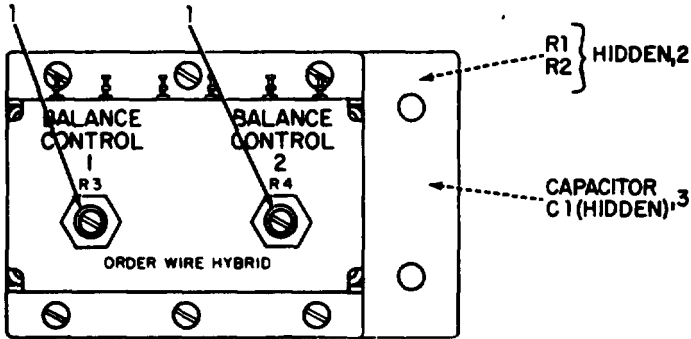

Figure 104. Tone Converter Shelves No. 1 and No. 3, Type 222, Model 4 (Sheet 2 of 2)

Section II REPAIR PARTS LIST



EL 5895-288-24P-TM-105

Figure 105. Order Wire Hybrid

Section II REPAIR PARTS LIST

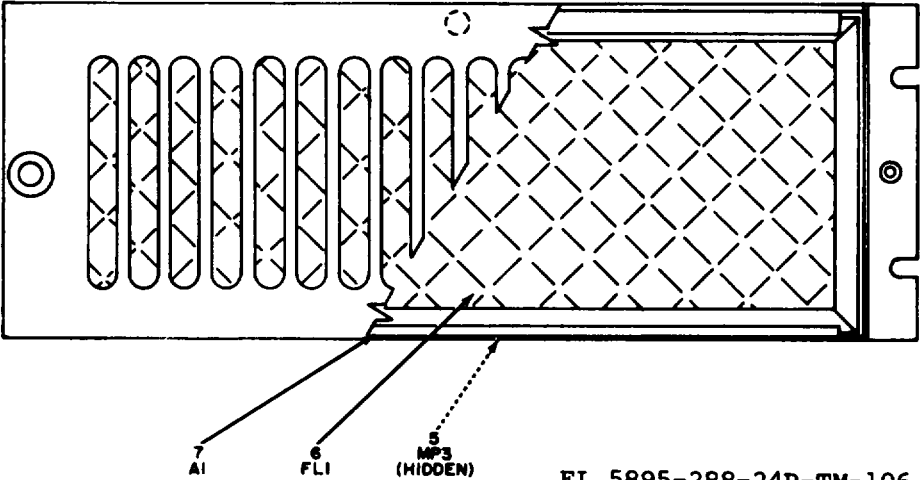
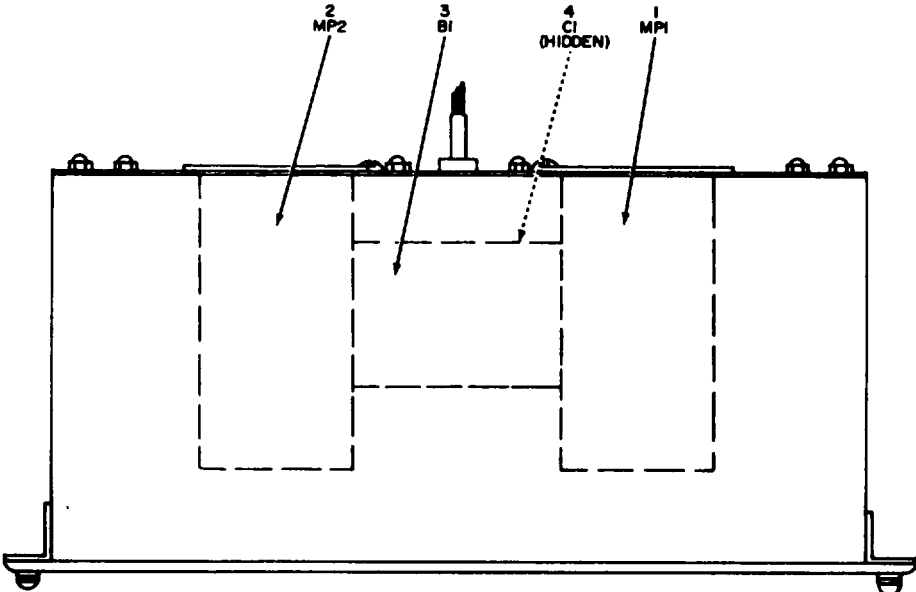
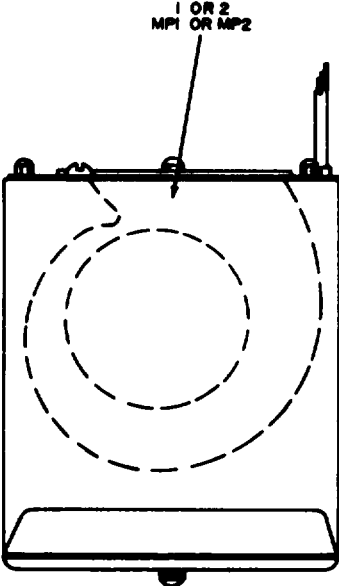

Figure 106. Cooling Fan

Section II REPAIR PARTS LIST

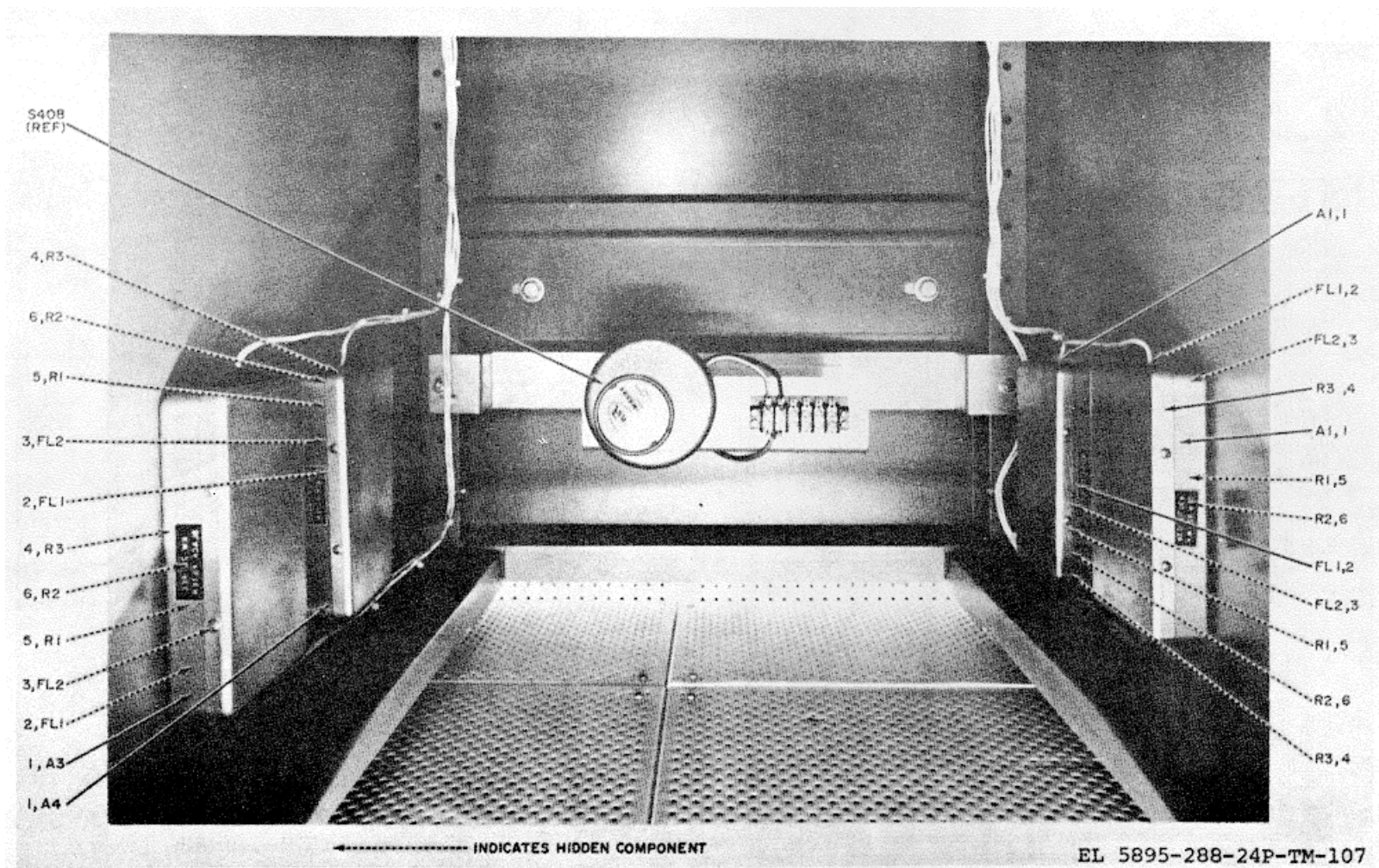

Figure 107. Installation Kit For TSEC/KW-26

Section II REPAIR PARTS LIST

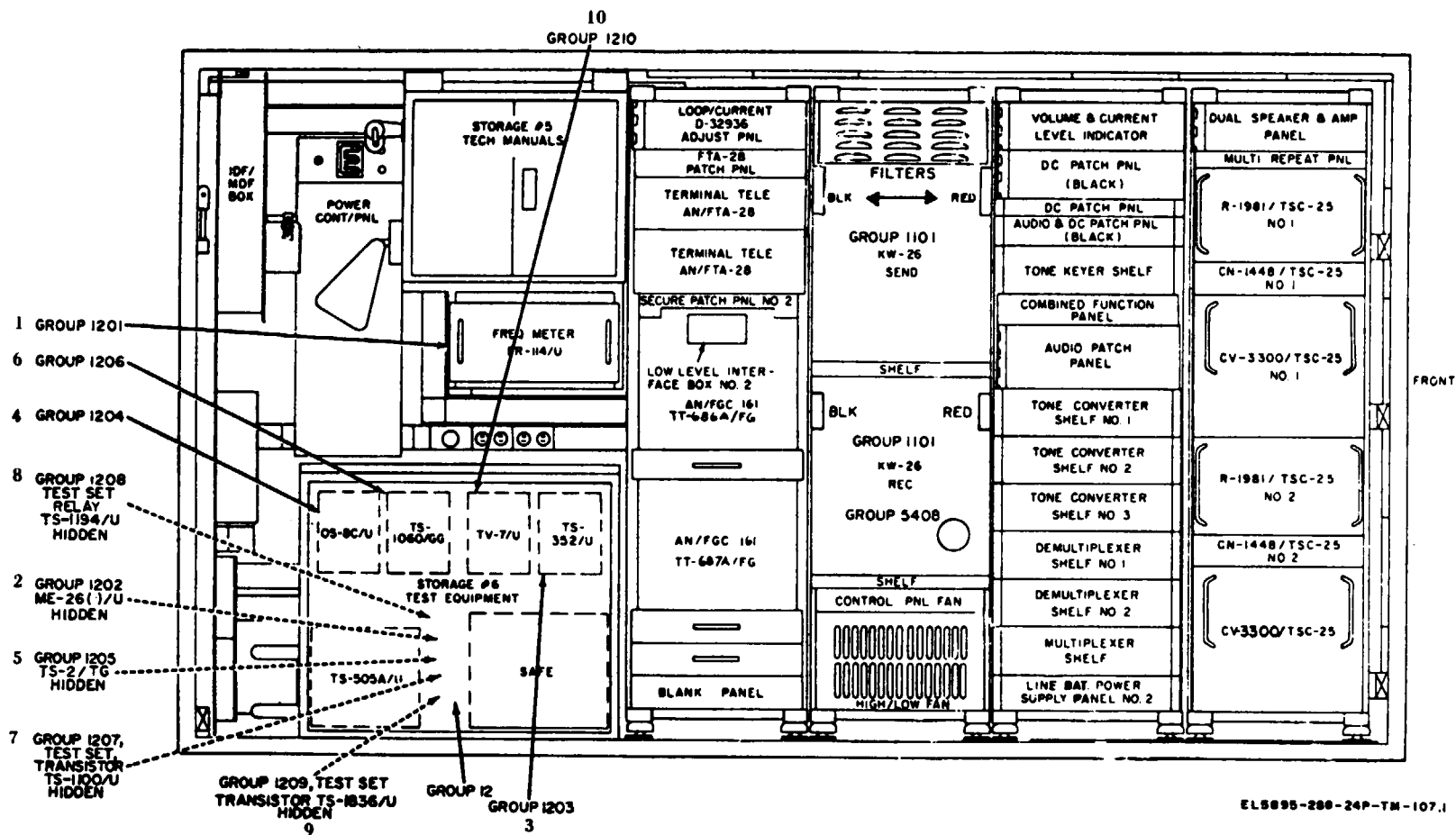
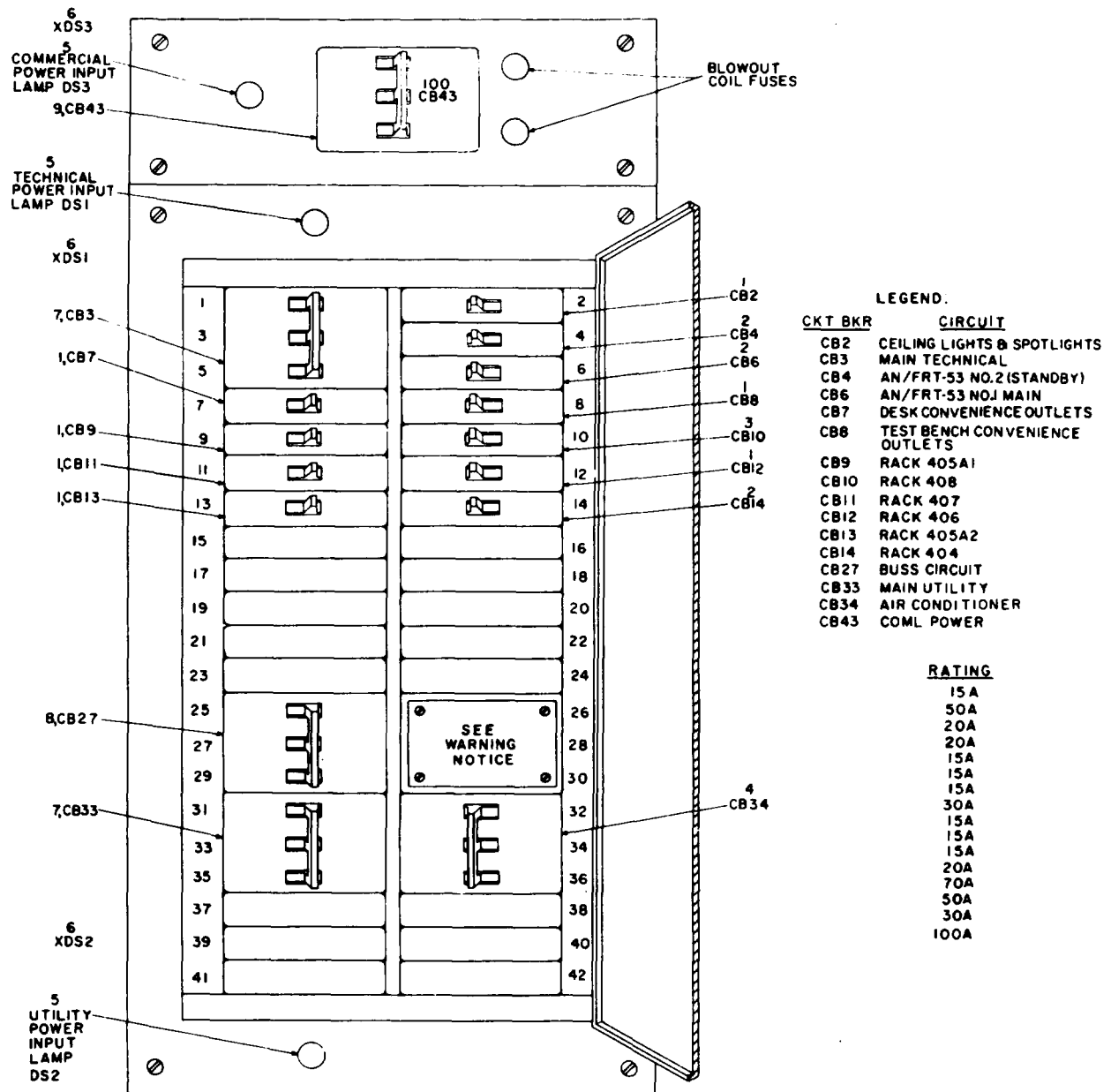

Figure 107.1. Test Equipment

Section II REPAIR PARTS LIST



EL 5895-288-24P-TM-108

Figure 108. Circuit Breaker Panel

Section II REPAIR PARTS LIST

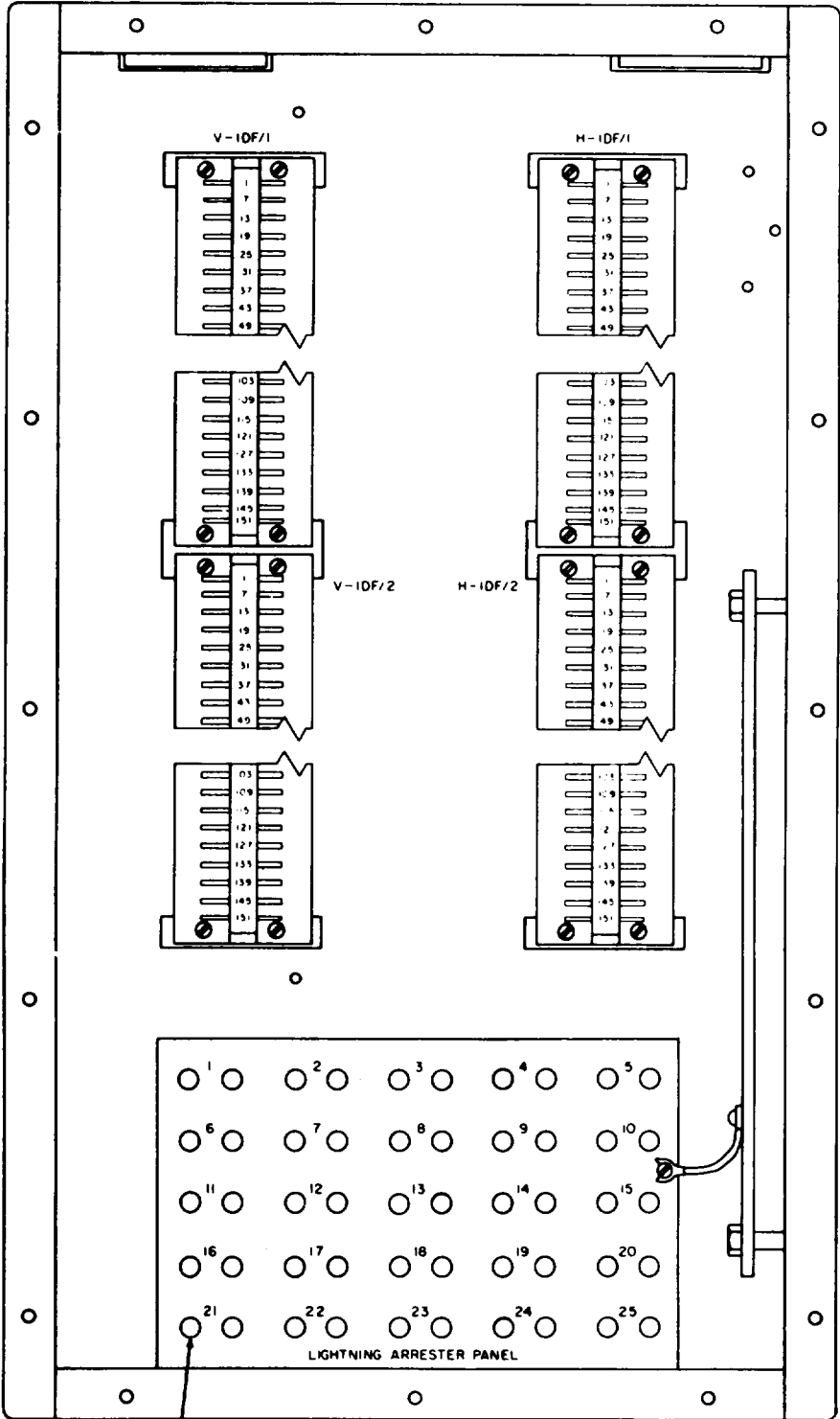

MPI THRU MP50
1

EL 5895-288-24P-TM-109

Figure 109. IDF/MDF Box

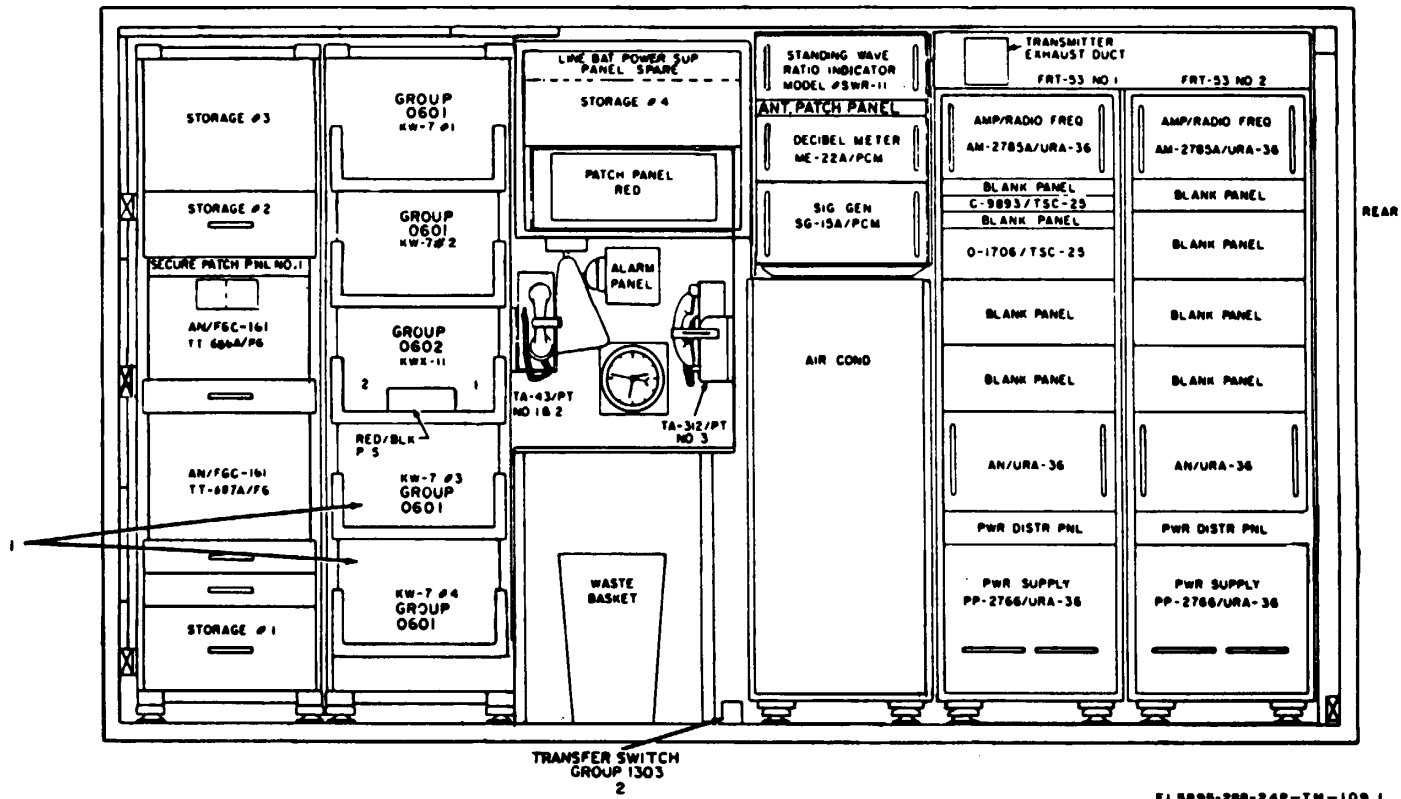

Figure 109.1. Miscellaneous Group

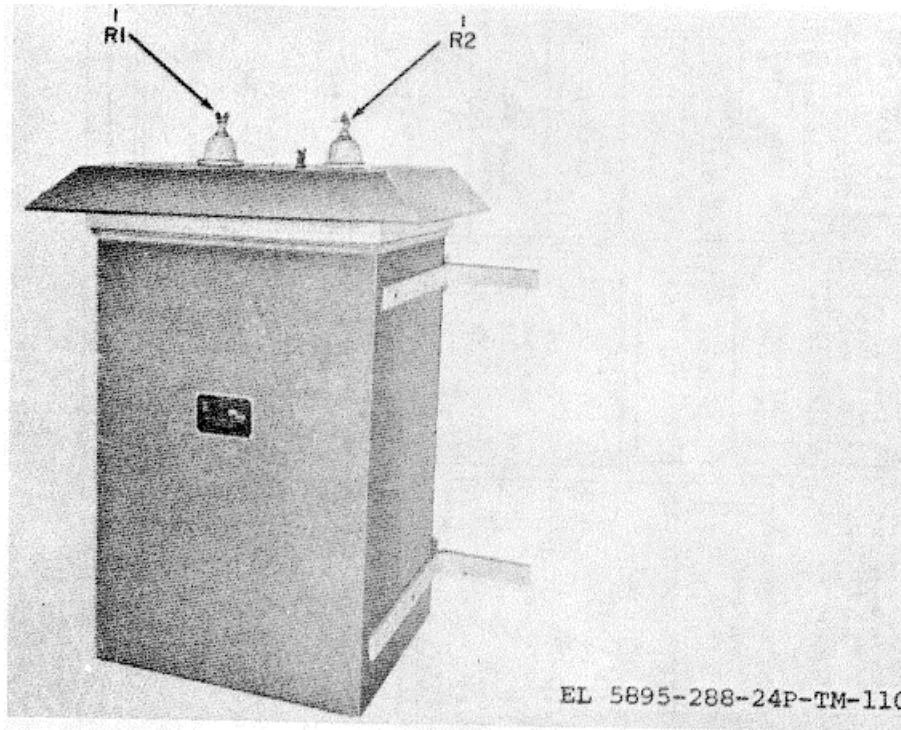

Figure 110. Dummy Load DA-314/U

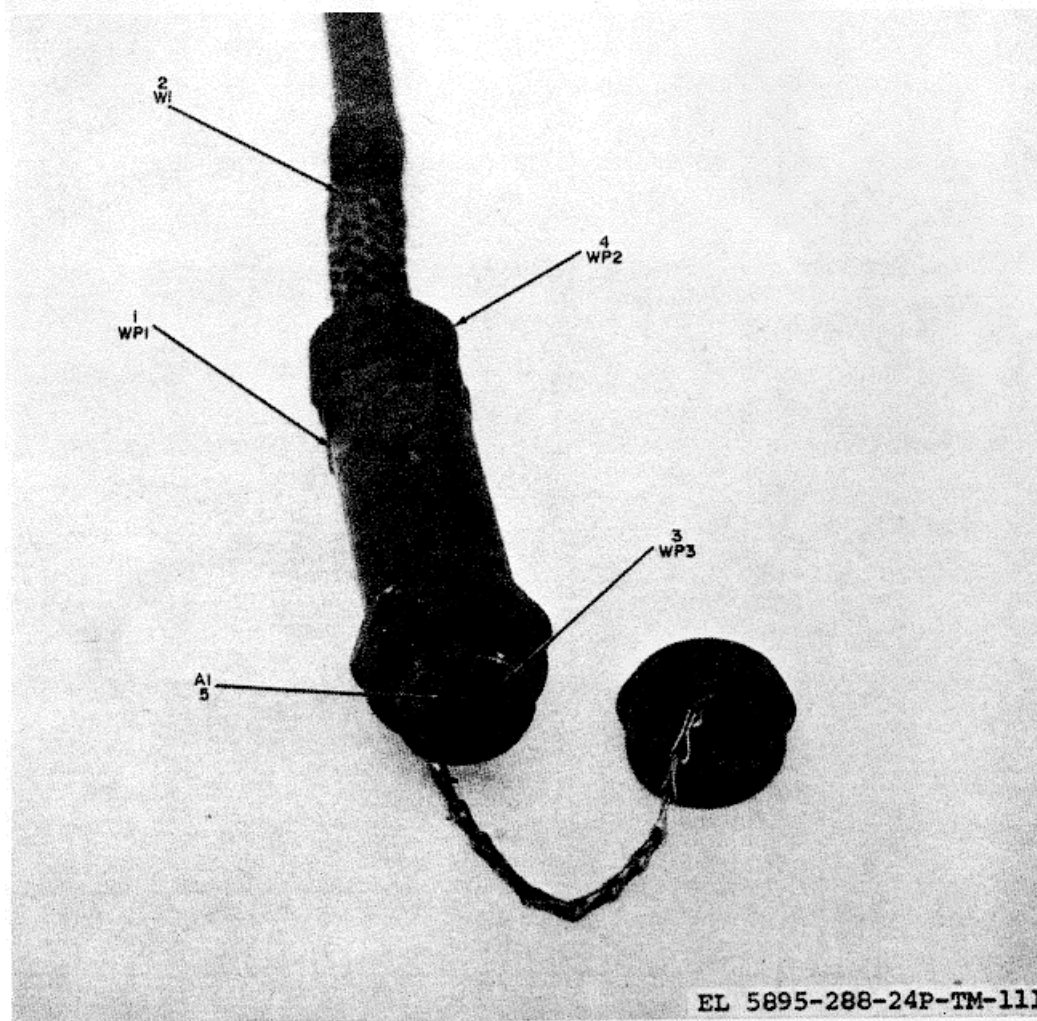

Figure 111. Power Cable EL 5895-288-24P-TM-111

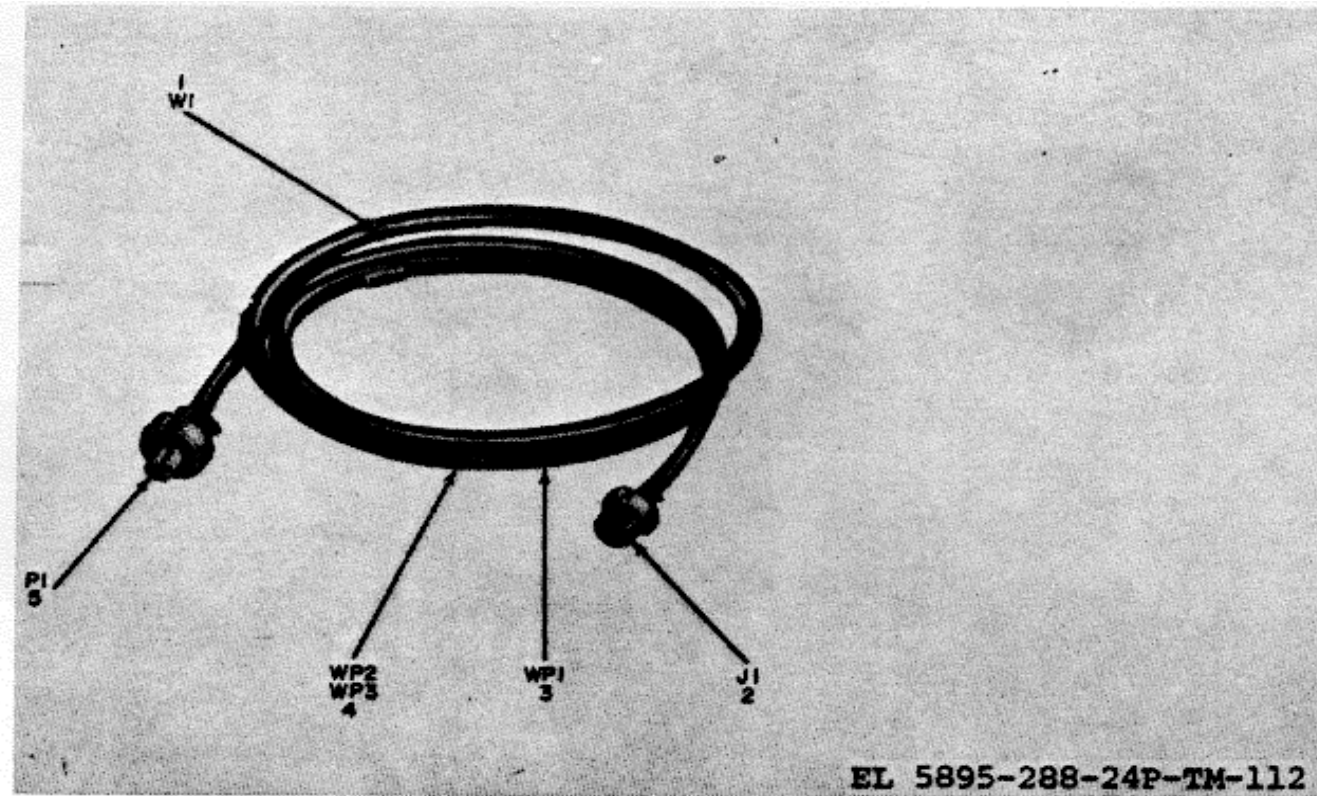

Figure 112. Electrical Cable Plug

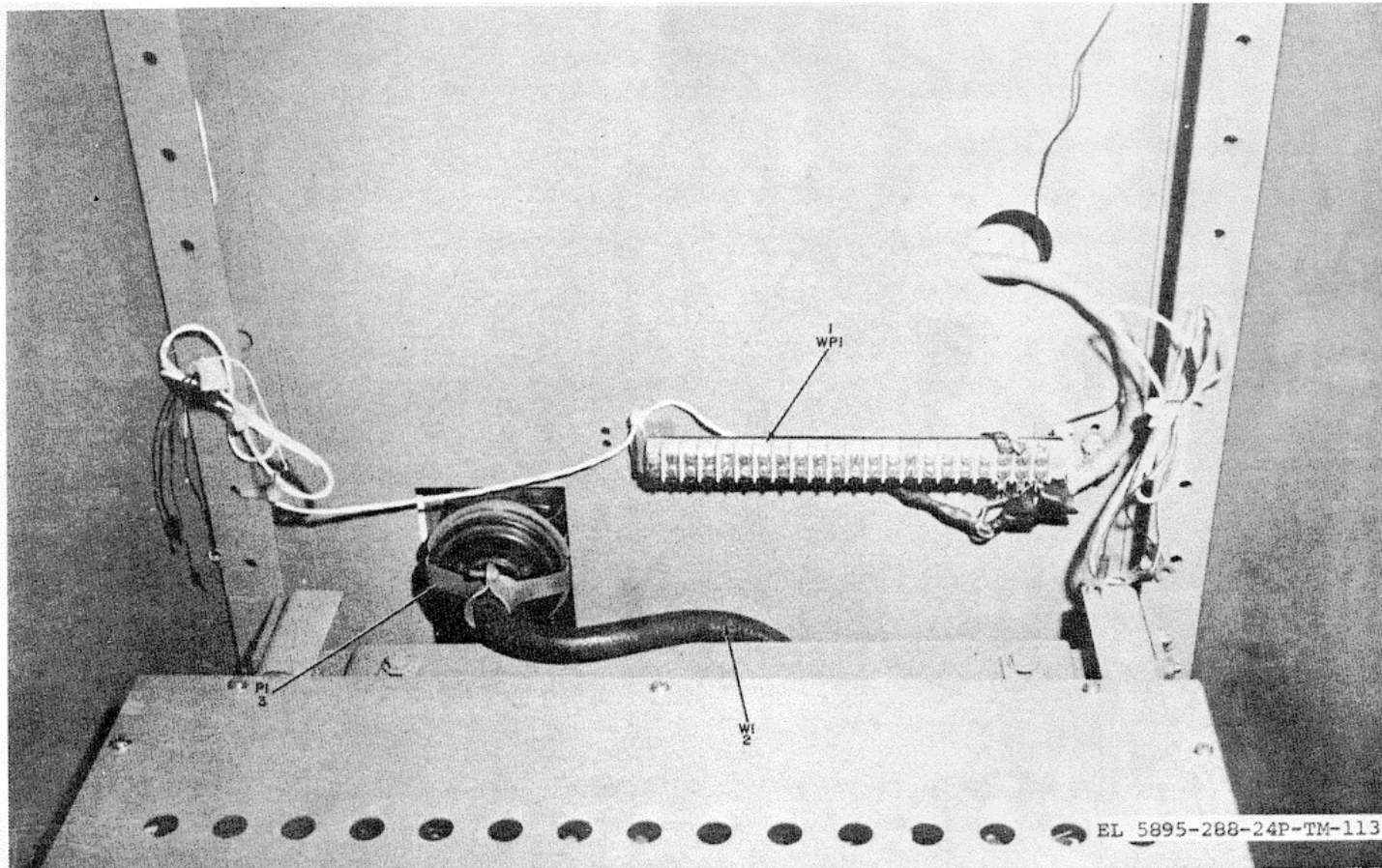

Figure 113. Electrical Power Cable, Rack 408

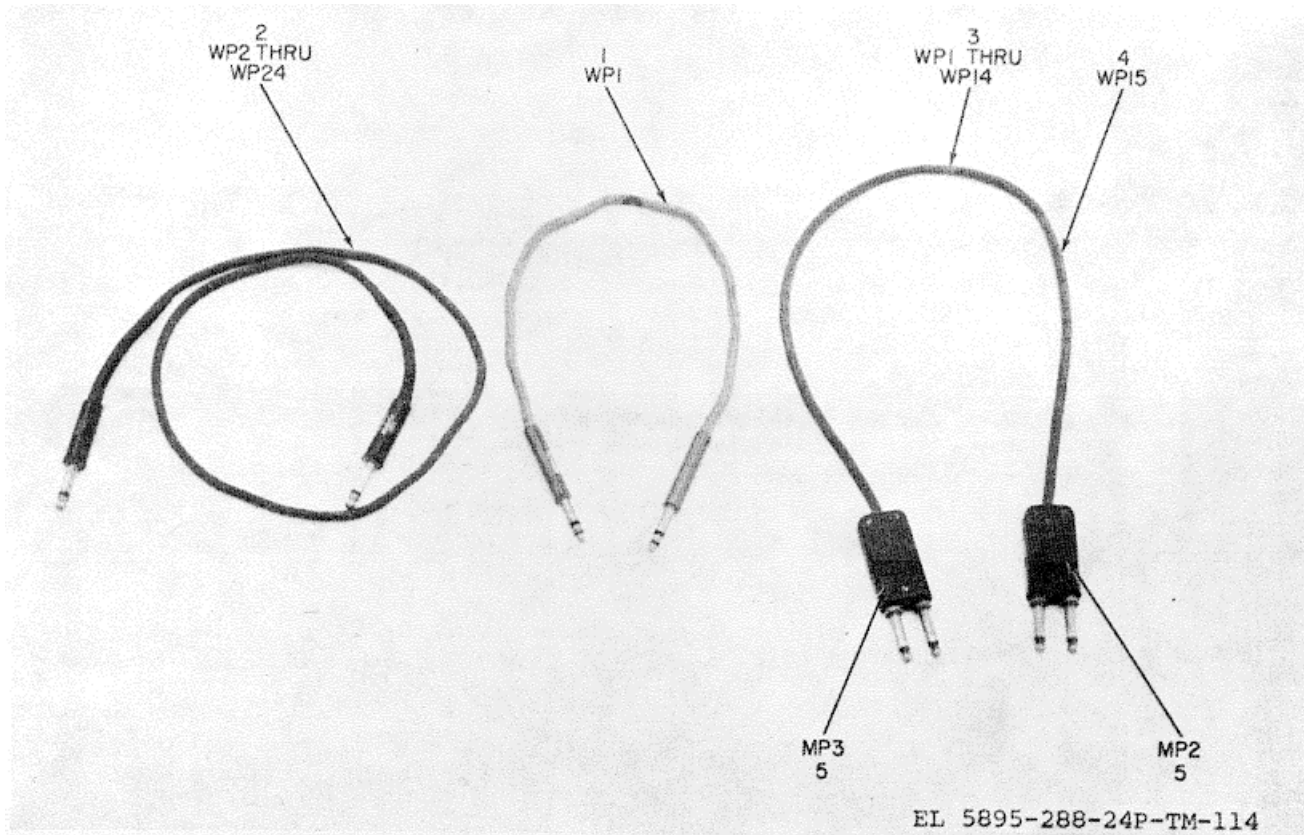
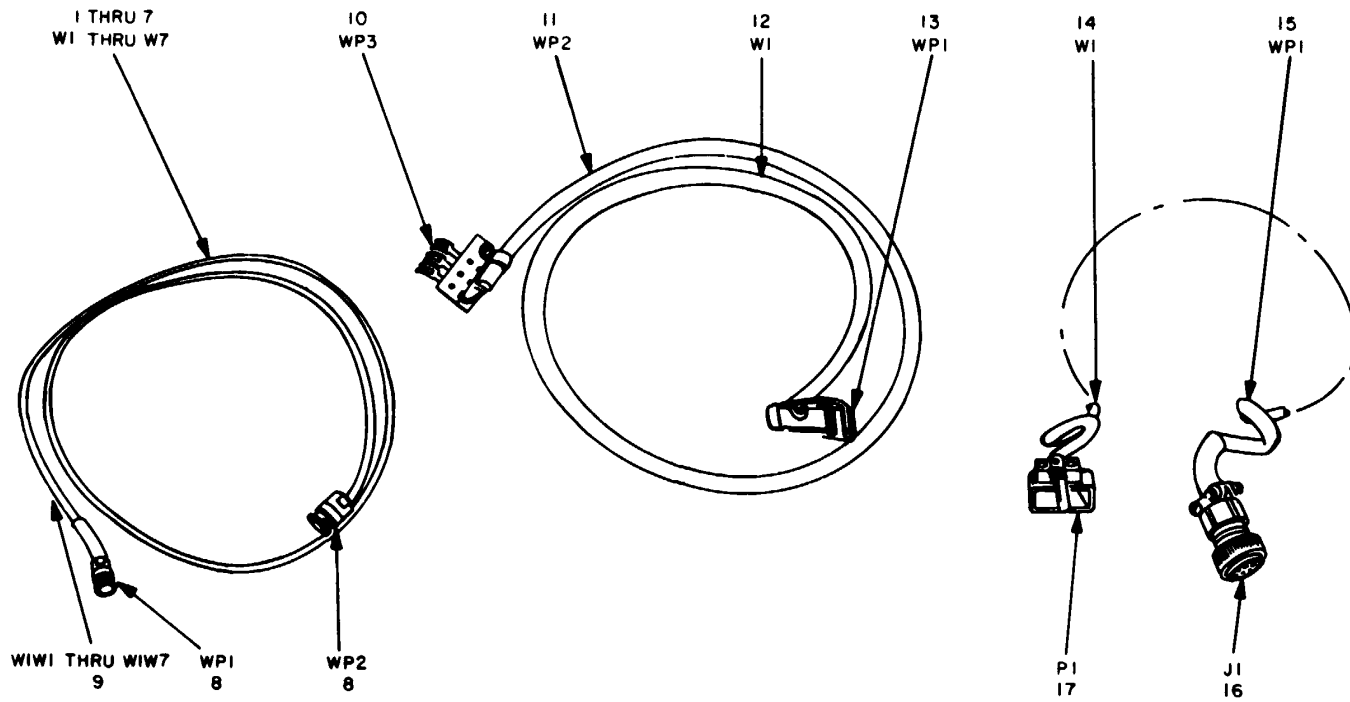

Figure 114. Cord Assemblies



EL 5895-288-24P-TM-115

Figure 115. Radio Frequency Cable Assembly CG-409E/U

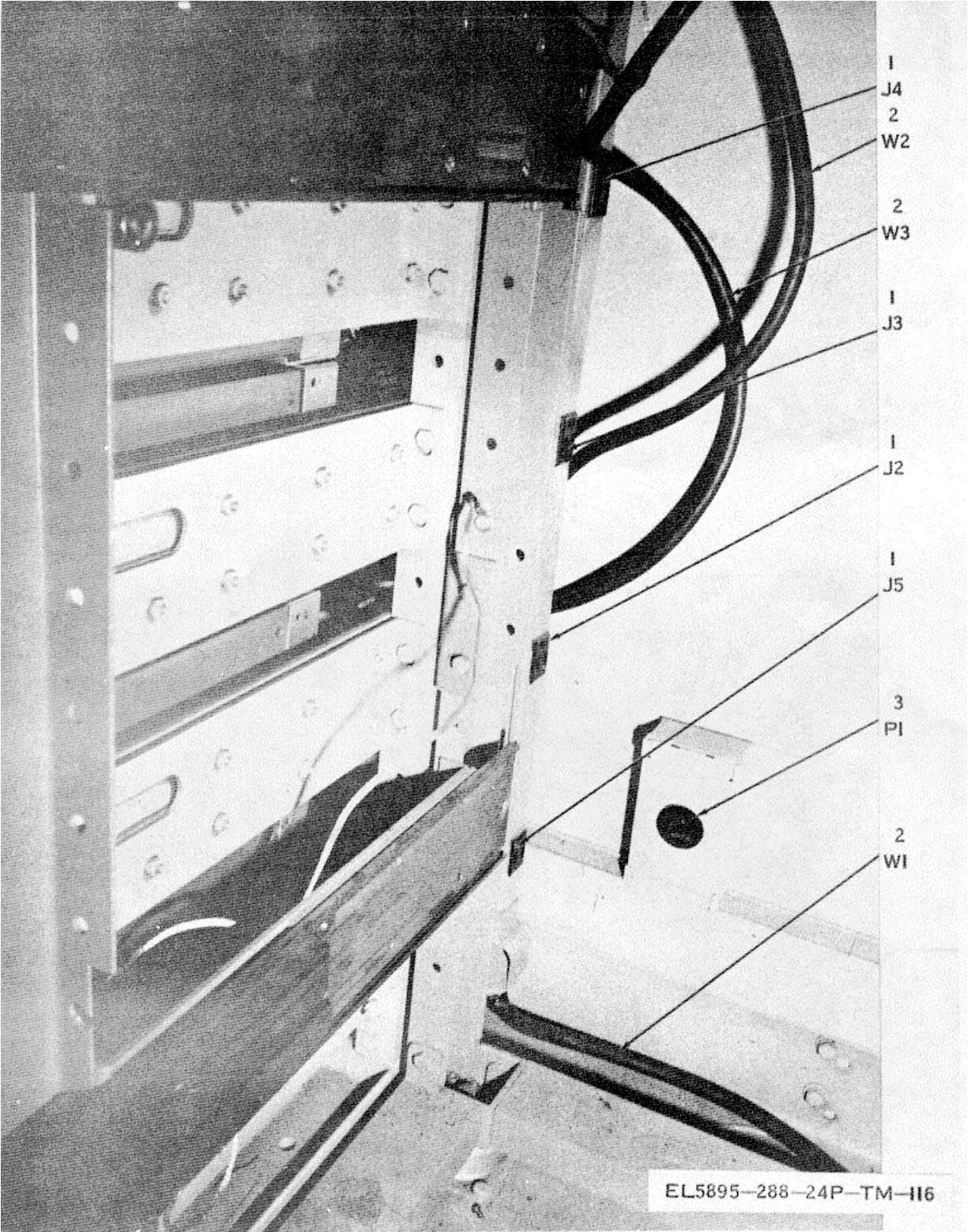

Figure 116. Power Cable Assemblies

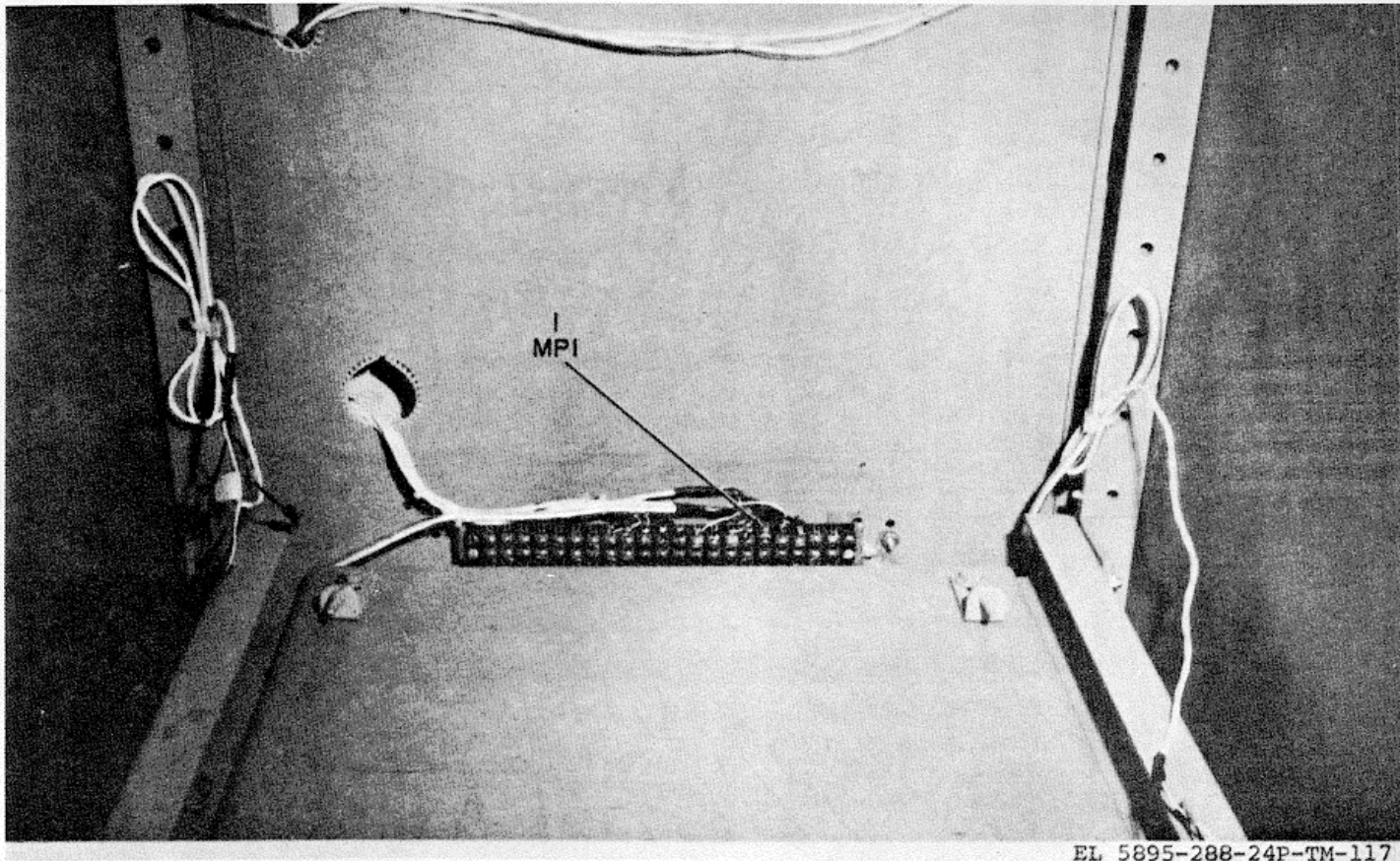
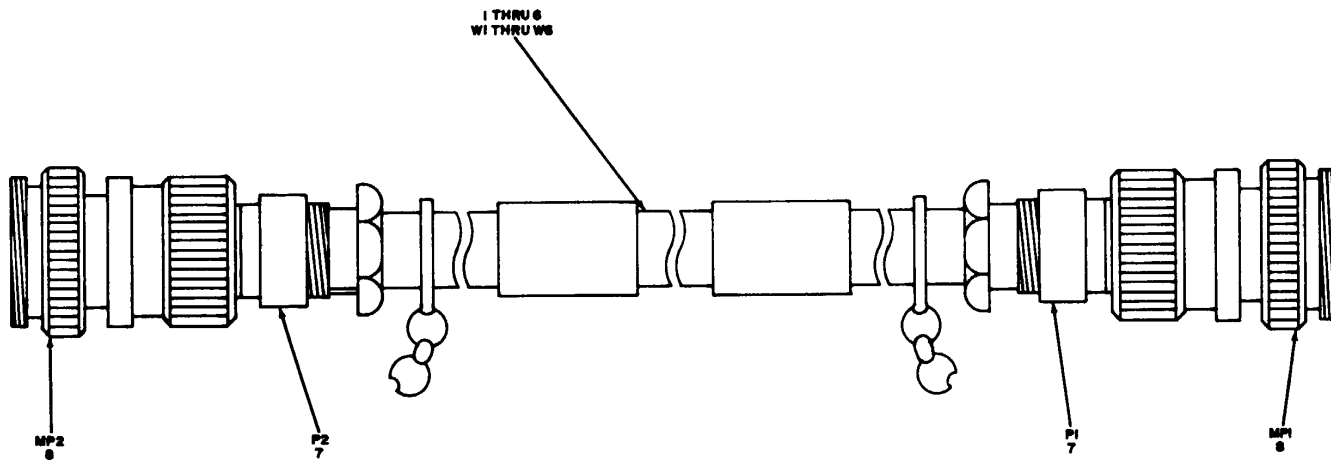

Figure 117. Barrier Terminal, KW-7 Rack



EL 5895-288-24P-TM-118

Figure 118. Radio Frequency Cable Assembly CG-1040B/U

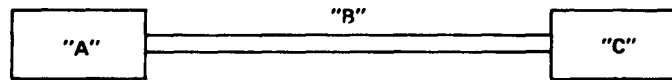

ILLUSTRATION REFERENCE KEY

Item No.	Reference
1.....	B
2.....	B
3.....	A
4.....	C
5.....	A
6.....	C
7.....	A
8.....	B
9.....	B
10.....	B
11.....	B
12.....	B
13.....	B
14.....	B
15.....	B
16.....	A
17.....	C
18.....	A
19.....	C
20.....	A
21.....	C
22.....	C

	ASSEMBLY	CONNECTORS AND CABLE		
		A	B	C
	Item No.	Item No.	Item No.	Item No.
LEAD TEST 18"	8	5	1	N/A
LEAD TEST 36"	9	5	1	N/A
LEAD TEST 42"	10	5	1	N/A
CORD ASSEMBLIES 6"	11	7	1	7
CORD ASSEMBLIES 12"	12	6	1	6
CORD ASSEMBLIES 18"	13	4	2	3
CORD ASSEMBLIES 24"	15	22	2	21

EL5895-288-24P-TM-119

Figure 119. Patch Cords, Test Leads, and Loose Connectors

SECTION IV NATIONAL STOCK NUMBER AND PART NUMBER INDEX

NOTE: LATEST NATIONAL STOCK NUMBER ASSIGNMENTS ARE INCLUDED AT END OF INDEX

NATIONAL STOCK NUMBER	FIG NO.	ITEM NO.	NATIONAL STOCK NUMBER	FIG NO.	ITEM NO.
2530-00-591-5175	3	27	5305-00-054-6653	58	100
3010-00-203-1630	85	8	5305-00-054-6668	58	101
3020-00-640-4758	58	9	5305-00-616-1137	58	85
3020-00-640-4824	58	7	5305-00-765-4252	58	93
3020-00-671-5826	58	20	5305-00-861-7247	93	3
3020-00-671-5832	58	51			
3020-00-671-8535	58	47	5305-00-861-7247	99	24
3020-00-679-9889	58	55	5305-00-861-7247	100	36
3020-00-683-9483	58	27	5305-00-861-7247	101	21
3020-00-697-7770	58	11	5306-00-576-0569	3	2
3020-00-810-9465	58	41	5310-00-171-8727	27	93
3020-00-925-0075	58	71	5310-00-171-8727	27	97
3020-00-938-7552	58	16	5310-00-171-8727	13	35
				14	25
3020-00-942-7802	58	24		15	25
				16	28
3020-00-942-7804	58	42		18	33
				19	56
3040-00-396-3116	58	1		22	22
				23	57
				25	30
				26	28
3040-00-942-4954	58	56		27	101
				31	9
3040-00-942-4955	58	57		32	20
5210-00-543-2410				58	103
3040-00-942-4957	58	59	5310-00-550-1720	3	18
3940-00-408-1485	3	3	5310-00-929-6395	50	4
3950-00-932-9751	3	53	5310-00-929-6395	58	102
4010-00-066-2749	3	47	5310-00-933-8119	58	104
5315-00-460-5793				58	129
4030-00-066-7235	3	52	5315-00-823-8744	58	118
5325-00-174-5317				45	5
4030-00-066-7236	3	44	5340-00-150-3045	45	6
5340-00-810-5570				89	1
4030-00-187-5261	3	39	5355-00-160-7108	48	2
4030-00-282-2510	3	40	5355-00-823-9810	42	2
4030-00-402-6566	3	15	5355-00-889-3468	100	29
4030-00-953-2327	3	25	5360-00-664-2197	58	12
4030-00-953-2344	3	4	5365-00-200-6707	58	80
4030-00-953-2346	3	35	5365-00-282-0782	58	76
4030-00-954-0169	3	54	5365-00-816-4239	58	79
4030-00-954-0813	3	24	5805-00-850-0070	37	7
4130-00-925-0509	106	6			
4140-00-060-1131	34		5805-00-862-2743	92	17
4140-00-013-0989	34	2			
4140-00-093-7679	84	10	5805-00-863-3667	93	6
4140-00-842-1131	4	19			
4140-00-842-1131	84	19	5805-00-863-3668	93	2
6120-00-818-5500	84	8			
5305-00-054-5648	58	96	5805-00-870-2289	104	12
5305-00-054-6650	50	2			
6306-00-054-6650	58	96	5805-00-871-0155	92	6
5306-00-054-6652	58	99			
6340-01-029-7522	34	2	5805-00-871-0155	94	2
			5805-00-871-0155	98	7

SECTION IV NATIONAL STOCK NUMBER AND PART NUMBER INDEX

NATIONAL STOCK NUMBER	FIG NO.	ITEM NO.	NATIONAL STOCK NUMBER	FIG NO.	ITEM NO.
5805-00-871-0155	104	6	5895-00-069-8753	1	
5805-00-884-5280	95	33	5895-00-439-8770	3	20
5805-00-884-5281	95	32	5895-00-493-8818	2	1
5805-00-884-5282	95	31	5895-00-537-2358	3	8
5805-00-884-5283	95	30	5895-00-543-0484	2	2
5805-00-884-5293	95	34	5895-00-553-7024	3	10
5805-00-884-5294	95	35	5895-00-857-1497	3	12
5805-00-884-5295	95	36	5895-00-857-1498	3	9
5805-00-884-5296	95	37	5895-00-874-3419	3	23
5805-00-886-5947	101	23	5895-00-874-3420	3	13
5810-00-252-4494	107	1	5895-00-885-5975	4	24
5811-00-349-8742	16	3	5895-00-885-8606	3	7
5811-00-349-8742	74	9	5895-00-937-0780	3	55
5815-00-001-0635	45	13	5895-00-953-4935	3	45
5815-00-434-2603	45	8	5895-00-964-3207	3	56
			5895-01-035-5364	21	
5815-00-511-4293	85	15	5905-00-060-1939	39	8
5820-00-149-1119	75				
5820-00-252-2777	56	20	5905-00-060-2790	101	10
5820-00-327-4393	60	3			
5820-00-327-4725	58	65	5905-00-060-5100	99	12
5820-00-511-4258	57	17			
5820-00-537-2306	79	22	5905-00-063-6318	48	20
5820-00-581-2601	78	21			
5820-00-618-6632	58	40			
5820-00-657-4708	58	13	5905-00-063-7573	45	10
5820-00-671-2936	58	46			
5820-00-671-5837	58	62	5905-00-101-7907	48	14
5820-00-784-5411	58	60			
5820-00-784-9315	58	6	5905-00-104-5755	20	35
5820-00-838-2646	56	19			
5820-00-838-2649	56	30	5905-00-104-5756	52	52
5820-00-838-2704	56	7			
5820-00-851-3898	52	58	5905-00-104-5756	77	18
5820-00-856-3411	58	50			
5820-01-010-4975	13				
5820-01-010-4078	14	1	5905-00-104-5756	77	23
5820-01-010-4976	14				
5820-01-010-4977	15		5905-00-104-5756	77	52
5820-01-010-4978	15	1			
5820-01-010-4978	20		5905-00-104-5756	82	14
5820-01-010-4979	16				
5820-00-010-4980	17		5905-00-104-5757	52	22
5820 01-010-4980	17	1			
5820-01-010-4981	19				
5820-01-010-4978		2	5905-00-104-8330	25	6
5820-01-010-4982	22		5905-00-104-8330	52	27
5820-01-010-4983	24	1			
5820-01-010-4984	25		5905-00-104-8330	52	54
5820-01-010-0084	20	1			
5820-01-010-4985	27	5	5905-00-104-8330	57	41
5820-01-010-4986	31				
5820-01-010-4987	23		5905-00-104-8330	77	34
5820-01-012-3727	18	1	5905-00-104-8330	77	57
5820-01-012-5464	33				
5820-01-016-8194	30	13	5905-00-104-8330	77	153
5820-01-016-8195	28	1			
5820-01-016-2205	30	20	5905-00-104-8330	77	171
5820-01-020-9714	63	25			
5820-01-022-9715	26	1	5905-00-104-8332	77	42
5820-01-022-9716	32	1			
5820-01-022-9717	26	1	5905-00-104-8333	52	8
5820-01-022-9717	6	3			
5820-01-022-9718	73	1	5905-00-104-8333	77	71
5898-01-013-5364	21				
5895-00-053-1770	3	50			
5895-00-053-1773	3	51			
5895-01-006-3834	3	46			
5895-00-066-2723	3	49			
5895-00-066-7232	3	48			

SECTION IV NATIONAL STOCK NUMBER AND PART NUMBER INDEX

NATIONAL STOCK NUMBER	FIG NO.	ITEM NO.	NATIONAL STOCK NUMBER	FIG NO.	ITEM NO.
5905-00-104-8334	77	98	5905-00-104-8368	66	15
5905-00-104-8334	77	104	5905-00-105-7764	16	53
5905-00-104-8334	79	4	5905-00-105-7764	17	29
5905-00-104-8335	56	62	5905-00-105-7764	18	67
5905-00-104-8335	57	43	5905-00-105-7764	19	35
5905-00-104-8335	77	24	5905-00-105-7764	23	50
5905-00-104-8335	77	70	5905-00-105-7764	26	42
5905-00-104-8335	77	212	5905-00-105-7764	29	86
5905-00-104-8336	52	9	5905-00-105-7764	29	96
5905-00-105-7764				51	25
5905-00-104-8336	56	78	5905-00-105-7764	66	18
5905-00-104-8336				65	8
5905-00-104-8336	77	120	5905-00-105-7765	27	30
5905-00-104-8336	77	157	5905-00-105-7767	14	1
5905-00-104-8336	77	161	5905-00-105-7767	15	1
5905-00-104-8336	77	200	5905-00-105-7767	22	47
5905-00-104-8339	52	3	5905-00-105-7767	23	32
5905-00-104-8345	51	45	5905-00-105-7767	68	12
5905-00-104-8346	56	85	5905-00-105-7768	13	42
5905-00-104-8346	77	25	5905-00-105-7768	14	3
5905-00-104-8346	77	53	5905-00-105-7768	15	3
5905-00-104-8346	77	185	5905-00-105-7768	16	7
5905-00-104-8348	20	47	5905-00-105-7768	17	14
5905-00-104-8348	77	33	5905-00-105-7768	18	45
5905-00-104-8348	77	43	5905-00-105-7768	19	29
5905-00-104-8348	77	162	5905-00-105-7768	23	38
5905-00-104-8348	77	220	5905-00-105-7768	27	68
5905-00-104-8350	20	32	5905-00-105-7768	67	8
5905-00-104-8350	56	52	5905-00-106-1278	13	47
5905-00-104-8351	51	40	5905-00-106-1278	18	42
5905-00-104-8355	51	43	5905-00-106-1278	24	34
5905-00-104-8363	74	26	5905-00-106-1282	52	30
5905-00-104-8368	13	44	5905-00-106-1282	56	41
5905-00-104-8368	17	24	5905-00-106-1282	77	134
5905-00-104-8368	18	26	5905-00-106-1356	13	2
5905-00-104-8368	19	18	5905-00-106-1356	16	52
5905-00-104-8368	23	27	5905-00-106-1356	17	22
5905-00-104-8368	24	37	5905-00-106-1356	18	63
5905-00-104-8368	26	45	5905-00-106-1356	19	49
5905-00-104-8368	27	23	5905-00-106-1356	22	15
5905-00-104-8368	28	12	5905-00-106-1356	26	71

SECTION IV NATIONAL STOCK NUMBER AND PART NUMBER INDEX

NATIONAL STOCK NUMBER	FIG NO.	ITEM NO.	NATIONAL STOCK NUMBER	FIG NO.	ITEM NO.
5905-00-106-1356	32	13	5905-00-106-9351	52	46
5905-00-106-1356	77	193	5905-00-106-9351	52	59
5905-00-106-1357	22	46	5905-00-106-9351	77	65
5905-00-106-1357	27	45	5905-00-106-9351	80	12
5905-00-106-1357	29	22A	5905-00-107-0656	18	46
5905-00-106-1357	70	18	5905-00-107-0656	24	43
5905-00-106-3666	13	11	5905-00-107-0656	25	17
5905-00-106-3666	16	21	5905-00-107-0656	26	77
5905-00-106-3666	17	33	5905-00-107-0656	28	8
5905-00-106-3666	18	15	5905-00-108-5445	42	1
5905-00-106-3666	19	36	5905-00-108-6922	77	3
5905-00-106-3666	22	4	5905-00-108-6922	77	151
5905-00-106-3666	23	24	5905-00-109-8358	13	1
5905-00-106-3666	25	19	5905-00-109-8358	14	4
5905-00-106-3666	26	62	5905-00-109-8358	15	4
5905-00-106-3666	27	33	5905-00-109-8358	17	21
5905-00-106-3666	32	14	5905-00-109-8358	18	64
5905-00-106-3666	63	38	5905-00-109-8358	19	48
5905-00-106-3666	67	13	5905-00-109-8358	23	21
5905-00-106-3667	13	50	5905-00-109-8358	24	17
5905-00-106-3668	18	48	5905-00-109-8358	25	7
5905-00-106-3668	24	22	5905-00-109-8358	26	33
5905-00-106-3668	26	58	5905-00-109-8358	27	51
5905-00-106-3668	27	38	5905-00-109-8358	28	10
5905-00-106-3668	66	9	5905-00-110-0196	20	33
5905-00-106-9344	52	58	5905-00-110-0196	51	33
5905-00-106-9344	77	175	5905-00-110-0196	52	12
5905-00-106-9345	77	99	5905-00-110-0196	78	4
5905-00-106-9345	77	105	5905-00-110-0310	57	44
5905-00-106-9345	77	210	5905-00-110-0388	16	41
5905-00-106-9345	80	18	5905-00-110-0388	17	26
5905-00-106-9348	60	5	5905-00-110-0388	19	37
5905-00-106-9348	77	15	5905-00-110-0388	22	49
5905-00-106-9348	77	39	5905-00-110-0388	23	48
5905-00-106-9348	77	40	5905-00-110-0388	27	22
5905-00-106-9348	77	51	5905-00-110-0388	28	15
5905-00-106-9348	77	54	5905-00-110-0388	68	21
5905-00-106-9348	77	198	5905-00-110-0993	45	16
5905-00-106-9351	29	102	5905-00-110-0993	77	20
5905-00-106-9351	52	45			

**SECTION IV NATIONAL STOCK NUMBER AND PART NUMBER INDEX
TM 11-5895-288-24P**

NATIONAL STOCK NUMBER	FIG NO.	ITEM NO.	NATIONAL STOCK NUMBER	FIG NO.	ITEM NO.
5905-00-110-0993	79	6	5905-00-111-4742	80	15
5905-00-110-7620	13	5	5905-00-111-4742	80	21
5905-00-110-7620	14	15	5905-00-111-4858	26	70
5905-00-110-7620	15	15	5905-00-111-4858	77	38
5905-00-110-7620	16	13	5905-00-111-4858	77	50
5905-00-110-7620	17	15	5905-00-111-4858	80	14
5905-00-110-7620	18	13	5905-00-111-4858	80	20
5905-00-110-7620	19	26	5905-00-111-8357	51	41
5905-00-110-7620	22	1	5905-00-111-8357	52	64
5905-00-110-7620	23	23	5905-00-111-8357	77	76
5905-00-110-7620	24	24	5905-00-111-8357	77	92
5905-00-110-7620	25	9	5905-00-111-8372	51	36
5905-00-110-7620	26	34	5905-00-111-8372	52	63
5905-00-110-7620	27	25	5905-00-111-8372	60	9
5905-00-110-7620	28	9	5905-00-111-8372	77	169
5905-00-110-7620	29	65	5905-00-113-4860	23	43
5905-00-110-7620	29	85	5905-00-113-4860	24	33
5905-00-110-7620	29	94	5905-00-113-4860	26	61
5905-00-113-4861				13	43
5905-00-110-7620	32	3	5905-00-113-4861	27	70
5905-00-110-7620	66	1	5905-00-114-0710	13	52
5905-00-110-7622	13	32	5905-00-114-0710	16	25
5905-00-110-7622	16	22	5905-00-114-0710	17	7
5905-00-110-7622	17	17	5905-00-114-0710	18	19
5905-00-110-7622	18	23	5905-00-114-0710	19	14
5905-00-110-7622	19	27	5905-00-114-0710	23	62
5905-00-110-7622	27	76	5905-00-114-0710	24	18
5905-00-110-7622	32	16	5905-00-114-0710	25	8
5905-00-111-4727	23	44	5905-00-114-0710	26	54
5905-00-111-4727	68	7	5905-00-114-0710	27	75
5905-00-111-4732	77	68	5905-00-114-0710	28	30
5905-00-111-4734	20	39	5905-00-114-0710	66	16
5905-00-114-0710				69	36
5905-00-111-4734	30	6	5905-00-114-0710	72	19
5905-00-114-0710				74	6
5905-00-111-4734	51	42	5905-00-114-0710	95	26
5905-00-114-0710				101	4
5905-00-111-4738	29	103	5905-00-114-0711	13	33
5905-00-114-0711				16	45
5905-00-111-4738	77	31	5905-00-114-0711	17	11
5905-00-114-0711				18	18
5905-00-111-4738	77	199	5905-00-114-0711	19	32
5905-00-114-0711				23	45
5905-00-111-4738	77	221	5905-00-114-0711	27	36
5905-00-111-4742	52	11			

**SECTION IV NATIONAL STOCK NUMBER AND PART NUMBER INDEX
TM 11-5895-288-24P**

NATIONAL STOCK NUMBER	FIG NO.	ITEM NO.	NATIONAL STOCK NUMBER	FIG NO.	ITEM NO.
5905-00-114-0711	32	5	5905-00-116-8554	68	29
5905-00-114-0711	68	31	5905-00-116-8555	14	18
5905-00-114-0711	77	190			
5905-00-114-1168	20	18	5905-00-116-8555	15	18
5905-00-114-5343	13	48	5905-00-116-8555	16	10
5905-00-114-5343	16	14	5905-00-116-8555	22	19
5905-00-114-5343	18	8	5905-00-116-8555	23	36
5905-00-114-5343	24	23	5905-00-116-8555	26	79
5905-00-114-5343	67	12	5905-00-116-8555	66	21
5905-00-114-5344	77	194			
5905-00-114-5361	77	59	5905-00-116-8556	13	30
5905-00-114-5388	20	38	5905-00-116-8556	16	48
5905-00-114-5393	52	65	5905-00-116-8556	18	60
5905-00-114-5393	62	3	5905-00-116-8556	22	44
5905-00-114-5407	52	51	5905-00-116-8556	27	42
5905-00-116-8556	51	18			
5905-00-114-5416	56	55	5905-00-116-8556	68	2
5905-00-114-5416	77	79	5905-00-116-8558	56	54
5905-00-114-5416	77	89	5905-00-116-8561	52	14
5905-00-114-5425	79	7	5905-00-116-8561	52	62
5905-00-114-5428	52	49	5905-00-116-8561	56	44
5905-00-114-5428	52	50	5905-00-116-8566	77	56
5905-00-114-5428	77	19	5905-00-116-8566	77	112
5905-00-114-5430	20	34	5905-00-116-8566	77	222
5905-00-114-5430	80	11	5905-00-116-8566	82	13
5905-00-114-5438	77	128	5905-00-116-8569	26	47
5905-00-114-5441	29	101	5905-00-116-8569	61	4
5905-00-114-5441	56	73	5905-00-116-8569	61	12
5905-00-114-5441	60	8	5905-00-118-4559	13	12
5905-00-114-5441	61	21	5905-00-118-4559	16	64
5905-00-114-5489	52	57	5905-00-118-4559	22	12
5905-00-114-5489	56	48	5905-00-118-4559	23	26
5905-00-114-5489	77	48	5905-00-118-4559	68	4
5905-00-114-5489	77	144	5905-00-119-3503	13	45
5905-00-114-5489	77	152	5905-00-119-3503	17	18
5905-00-114-5489	77	173	5905-00-119-3503	18	40
5905-00-119-3503	18	58			
5905-00-114-5489	77	191	5905-00-119-3503	19	30
5905-00-114-5489	77	211	5905-00-119-3503	23	30
5905-00-114-5489	78	9	5905-00-119-3503	26	40
5905-00-115-3560	77	195			
5905-00-115-8055	25	23	5905-00-119-3504	13	6
5905-00-115-8055	70	7	5905-00-119-3504	17	3
5905-00-116-8554	18	52	5905-00-119-3504	19	7

SECTION IV NATIONAL STOCK NUMBER AND PART NUMBER INDEX

NATIONAL STOCK NUMBER	FIG NO.	ITEM NO.	NATIONAL STOCK NUMBER	FIG NO.	ITEM NO.
5905-00-119-3504	22	5	5905-00-126-6683	15	35
5905-00-119-3504	27	39	5905-00-126-6683	16	63
5905-00-119-3505	27	46	5905-00-126-6683	17	8
5905-00-119-3505	69	27	5905-00-126-6683	18	44
5905-00-119-8768	24	16	5905-00-126-6683	19	13
5905-00-119-8768	27	44	5905-00-126-6683	23	35
5903-00-119-8768	70	6	5905-00-126-6683	26	78
5905-00-119-8811	25	20	5905-00-126-6683	27	50
5905-00-126-6683	53	9			
S905-00-119-8811	27	48	5905-00-126-6683	70	27
5905-00-119-8811	32	10	5905-00-126-6688	18	11
5905-00-119-8812	17	23	5905-00-126-6688	27	49
S905-00-119-8812	18	10	5905-00-127-9399	70	26
5905-00-119-8812	19	4	5905-00-131-1255	13	24
5905-00-119-8812	24	19	5905-00-131-1255	18	39
5905-00-119-8812	26	57	5905-00-131-1255	22	26
5905-00-119-8812	27	31	5905-00-131-1255	26	55
5905-00-119-8812	28	27	5905-00-131-1255	66	28
590S-00-120-9152	70	5	5905-00-133-0379	51	38
5905-00-120-9154	13	9	5905-00-133-0440	17	34
5905-00-120-9154	16	11	5905-00-133-0440	18	65
5905-00-120-9154	17	5	5905-00-133-0440	19	47
5905-00-120-9154	18	7	5905-00-133-0440	26	32
5905-00-120-9154	19	15	5905-00-135-3971	17	6
5905-00-120-9154	22	9	5905-00-135-3971	18	20
5905-00-120-9154	27	40	5905-00-135-3971	19	11
5905-00-120-9154	29	49	5905-00-135-3971	24	26
5905-00-120-9154	29	51	5905-00-135-3971	26	53
5905-00-120-9154	29	81	5905-00-135-3973	16	44
5905-00-120-9154	32	11	5905-00-135-3973	17	25
5905-00-120-9154	66	24	5905-00-135-3973	18	3
5905-00-121-9861	20	13	5905-00-135-3913	19	34
5905-00-121-9861	77	28	5905-00-135-3973	22	52
5905-00-121-9919	26	36	5905-00-135-3973	26	38
5905-00-121-9932	17	9	5905-00-135-3973	27	57
5905-00-121-9932	18	22	5905-00-135-3973	29	67
5905-00-121-9932	19	16	5905-00-135-3973	63	25
5905-00-121-9932	23	42	5905-00-135-3973	72	11
5905-00-126-6683	13	31	5905-00-135-3915	24	38
5905-00-126-6683	14	36	5905-00-135-3975	25	2

SECTION IV NATIONAL STOCK NUMBER AND PART NUMBER INDEX

NATIONAL STOCK NUMBER	FIG NO.	ITEM NO.	NATIONAL STOCK NUMBER	FIG NO.	ITEM NO.
5905-00-135-3975	26	43	5905-00-141-0598	77	196
5905-00-135-6045	16	65	5905-00-141-0598	80	3
5905-00-135-6045	18	51	5905-00-141-0598	80	27
5905-00-135-6045	27	24	5905-00-141-0599	45	11
5905-00-135-6045	28	11	5905-00-141-0600	29	105
5905-00-135-6046	17	20	5905-00-141-0600	56	75
5905-00-135-6046	18	30	5905-00-141-0717	16	18
5905-00-135-6046	19	21	5905-00-141-0717	18	55
5905-00-135-6046	68	23	5905-00-141-0717	22	17
5905-00-135-6046	77	183			
5905-00-136-7104	29	25	5905-00-141-0717	26	60
5905-00-136-8406	18	66	5905-00-141-0717	27	21
5905-00-141-0591	26	75	5905-00-141-0717	28	13
5905-00-141-0591	56	49	5905-00-141-0717	29	89
5905-00-141-0591	77	78	5905-00-141-0717	29	92
5905-00-141-0591	77	90	5905-00-141-0726	23	53
5905-00-141-0591	77	145	5905-00-141-0742	18	31
5905-00-141-0591	77	167	5905-00-141-0742	23	22
5905-00-141-0591	77	214	5905-00-141-0742	24	28
5905-00-141-0591	79	1	5905-00-141-0742	26	52
5905-00-141-0592	51	23	5905-00-141-0742	28	1
5905-00-141-0592	77	16	5905-00-141-0742	74	23
5905-00-141-0592	77	30	5905-00-141-0743	67	22
5905-00-141-0592	77	81	5905-00-141-0744	25	22
5905-00-141-0592	77	88	5905-00-141-0744	27	89
5905-00-141-0592	79	5	5905-00-141-0744	67	19
5905-00-141-0593	77	58	5905-00-141-1071	51	20
5905-00-141-0593	77	100	5905-00-141-1071	51	32
5905-00-141-0593	77	106	5905-00-141-1071	52	44
5905-00-141-0595	77	35	5905-00-141-1071	56	53
5905-00-141-0595	77	141	5905-00-141-1071	77	17
5905-00-141-0595	77	148	5905-00-141-1071	77	49
5905-00-141-0595	77	156	5905-00-141-1071	77	77
5905-00-141-0595	77	197	5905-00-141-1071	77	187
5905-00-141-0595	77	208	5905-00-141-1071	78	2
5905-00-141-0596	20	28	5905-00-141-1116	20	48
5905-00-141-0596	77	113	5905-00-141-1116	29	104
5905-00-141-0596	77	117	5905-00-141-1116	77	82
5905-00-141-0596	77	142	5905-00-141-1116	77	91
5905-00-141-0596	77	215	5905-00-141-1149	77	26

SECTION IV NATIONAL STOCK NUMBER AND PART NUMBER INDEX

NATIONAL STOCK NUMBER	FIG NO.	ITEM NO.	NATIONAL STOCK NUMBER	FIG NO.	ITEM NO.
5905-00-141-1165	61	13	5905-00-246-9396	27	59
5905-00-141-1168	52	34	5905-00-246-9396	27	63
5905-00-141-1168	56	45	5905-00-246-9396	28	4
5905-00-141-1168	65	36	5905-00-246-9396	28	5
59Q5-00-141-1168	77	32	5905-00-246-9396	28	17
5905-00-141-1168	78	10	5905-00-246-9396	28	19
5905-00-141-1183	13	18	5905-00-247-8700	80	22
5905-00-141-1183	14	2	5905-00-247-8710	54	19
5905-00-141-1183	15	2	5905-00-247-8715	51	44
5905-00-141-1183	16	9	5905-00-247-8733	56	80
5905-00-141-1183	22	27	5905-00-247-8735	51	35
5905-00-141-1183	23	33	5905-00-247-8749	52	66
5906-00-249-4248				62	27
5905-00-141-1183	24	31	5905-00-252-1046	51	27
5905-00-141-1183	26	48	5905-00-252-1046	52	61
5905-00-141-1183	27	26	5905-00-252-1050	56	83
5905-00-141-1183	29	48	5905-00-252-1050	77	114
5905-00-141-1183	29	50	5905-00-252-1050	80	23
5905-00-141-1183	68	6	5905-00-254-7096	77	174
5905-00-141-5393	77	69	5905-00-254-7101	82	11
5905-00-141-5393	77	96	5905-00-255-3664	16	27
5905-00-141-5393	77	149	5905-00-257-0926	77	206
	77	96	5905-00-257-2631		
5905-00-141-5393	77	172			
			5106-00-279-1691	91	9
5905-00-141-5393	77	188	5905-00-279-1692	100	17
			5905-00-279-1726	91	7
5905-00-141-5393	77	209	5905-00-279-1738	55	23
			5905-00-279-1740	77	186
5905-00-141-5393	78	3	5905-00-279-1876	48	18
5905-00-141-5393	80	17	5905-00-279-1876	102	6
5905-00-171-1975	29	99	5905-00-279-1979	95	15
5905-00-171-2006	48	17	5905-00-279-2302	82	15
5905-00-174-4958	79	16	5906-00-279-2517	52	49
5905-00-185-6966	52	61	5905-00-279-2522	92	9
5905-00-186-3008	53	46			
5905-00-189-2493	61	30	5905-00-279-2522	98	12
5905-00-185-6946	77	16			
5905-00-192-3973	102	9	5905-00-279-2522	104	8
5905-00-192-3987	53	7	5905-00-279-2527	52	35
5905-00-192-4408	81	20			
5905-00-192-6390	53	1	5905-00-279-2528	77	27
5905-00-195-2353	46	2			
5905-00-195-6806	102	5	5905-00-279-2529	71	9
5905-00-221-5842	51	24	5905-00-279-2545	91	3
5905-00-221-5842	7	29	5905-00-279-2547	91	4
5905-00-228-5506	52	30	5905-00-279-2629	91	2
5905-00-229-2620					
5905-00-232-2983	83	7			
5905-00-236-9858	77	139	5905-00-279-2650	105	2
5905-00-246-9393	72	28	5905-00-279-2651	48	19

SECTION IV NATIONAL STOCK NUMBER AND PART NUMBER INDEX

NATIONAL STOCK NUMBER	FIG NO.	ITEM NO	NATIONAL STOCK NUMBER	FIG NO	ITEM NO
5905-00-279-2656	91	6	5905-00-681-6462	100	23
5905-00-279-3503	96	9	5905-00-681-6462	101	7
5905-00-279-3506	97	1	5905-00-681-6462	103	8
5905-00-279-3506	107	6	5905-00-681-6894	99	13
5905-00-279-3513	107	4	5905-00-681-8760	99	4
5905-00-279-3519	101	8	5905-00-681-8818	95	6
5905-00-284-3200	61	19	5905-00-681-8818	100	11
5905-00-299-1541	95	11	5905-00-681-8818	101	18
5905-00-299-2051	91	5	5905-00-681-8853	95	5
5905-00-299-2052	91	8	5905-00-681-8957	87	6
			5905-00-681-9021	27	34
5905-00-299-2058	101	17	5905-00-681-9969	100	12
			5905-00-681-9969	101	13
5905-00-299-2059	91	12	5905-00-681-9969	103	7
			5906-00-682-4098	17	31
5905-00-342-3382	61	27	5905-00-683-410-	13	42
			5905-00-683-2235	53	2
5905-00-348-2454	61	29	5905-00-683-2235	77	189
5905-00-409-7616	52	52	5905-00-683-2235	99	10
5905-00-428-5039	61	31	5905-00-683-2238	77	170
			5905-00-683-2238	95	1
5905-00-429-9923	71	8	5905-00-683-2238	99	5
5905-00-434-2023	77	136	5905-00-683-2238	100	19
5905-00-448-0508	13	45			
5905-00-473-5251	63	28	5905-00-683-2238	101	16
5905-00-485-4545	27	32	5905-00-683-2238	103	13
5905-00-485-4564	61	25	5905-00-683-2240	95	18
5905-00-498-5786	23	15A	5905-00-683-2240	99	14
5905-00-498-5786	23	47	5905-00-683-2240	100	2
5905-00-501-5184	76	6	5905-00-683-2240	101	5
5905-00-501-5184	77	12	5905-00-683-2242	95	7
5905-00-506-6446	61	26	5905-00-683-2242	100	5
5905-00-518-5593	77	7	5905-00-683-2243	100	13
			5905-00-683-7721	77	192
5905-00-518-5595	77	10	5905-00-683-7721	95	27
5905-00-523-8387	54	3	5905-00-683-7721	99	2
5905-00-539-2567	77	4			
5905-00-552-2093	76	39	5905-00-686-3129	63	9
5905-00-577-1792	95	8	5905-00-686-3131	27	69
5905-00-577-7137	54	18			
5906-00-577-9987	76	30			
5905-00-603-5855	61	7			
5905-00-636-6742	51	46			
5905-00-636-7787	51	47			
5905-00-646-5958	77	13	5905-00-686-3903	100	24
5905-00-665-6850	96	7	5905-00-686-3903	101	14
5905-00-666-2555	91	1			
5905-00-676-8776	100	4	5905-00-686-9993	63	12
5905-00-681-6462	51	22			
5905-00-681-6462	99	26	5905-00-686-9995	100	26
			5905-00-686-996	53	45

SECTION IV NATIONAL STOCK NUMBER AND PART NUMBER INDEX

NATIONAL STOCK NUMBER	FIG NO.	ITEM NO	NATIONAL STOCK NUMBER	FIG NO	ITEM NO
5905-00-687-0002	101	19	5905-00-855-3173	100	10
5905-00-687-0007	99	16	5905-00-866-5184	95	41
5905-00-688-3738	63	37	5905-00-885-5914	48	12
5905-00-702-1143	99	18	5905-00-892-5202	107	5
5905-00-723-5251	95	24	5905-00-894-3488	51	15
5905-00-723-5251	95	28	5905-00-935-8543	56	79
5905-00-723-5251	101	11	5905-00-935-8544	13	10
5905-00-725-6995	63	22	5905-00-935-8544	77	139
5905-00-727-8001	95	23	5905-00-935-8545	27	72
5905-00-734-1549	51	16	5905-00-935-8545	77	137
5905-00-752-3767	29	46	5905-00942-9326	77	196
5905-00-752-3767	29	107	5905-00-952-2146	99	15
5905-00-773-8191	110	1	5905-00-985-5435	103	5
5905-00-801-6998	103	11	5906-00-107-0656	66	23
5905-00-802-6730	63	34	5910-00-009-9992	71	1
5905--82730	13	14	5910-00-010-8666	53	28
5905-00-806-0636	73	29	5910-00-018-8781	51	2
5905-00-808-1478	100	6	5910-00-056-7976	73	74
5905-00-809-9829	55	22	5910-00-060-9619	77	176
5905-00-810-2779	63	14	5910-00-060-9619	77	224
5905-00-814-1520	81	8	5910-00-060-9619	78	5
5905-00-815-5498	54	20	59104-078-1529	89	34
5905-00-833-5511	49	3	5910-00-079-5688	67	16
5905-00-835-9515	45	14	5910-00-084-0938	52	1
5905-00-837-1710	52	18	5910-0488-0756	56	36
5905-00-837-1710	53	19	5910-00-089-3496	72	15
5905-00-849-4321	103	14	5910-00-102-8031	31	1
5905-00-849-4322	103	15	5910-00-102-8031	30	9
5905-00-849-4402	94	4	5910-00-112-7529	49	1
5905-00-849-4422	95	39	5910-00-129-9234	76	27
5905-00-849-4422	100	1	5910-00-131-1319	50	18
5905-00-849-4434	103	2	5910-00-161-1635	81	5
5905-00-849-7077	95	12	5910-00-165-2751	61	11
5905-00-849-7077	99	3	5910-00-222-6127	77	124
5905-00-849-7077	103	9	5910-00-222-6127	85	7
5905-00-851-2401	16	24	5910-00-227-0796	80	9
5905-00-851-4199	92	10	5910-00-270-3196	53	5
5905-00-851-4199	94	3	5910-00-270-3196	56	76
5905-00-851-4199	98	9	5910-00-276-6887	77	118
5905-00-851-4199	104	11	5910-00-280-8393	45	7
5905-00-854-6592	32	7	5904-00-401-2993	66	20
			5910-00-421-6310	76	36
			5910-00-436-1064	77	60
			5910-00-436-1064	77	111
			5910-00-436-1064	77	140
			5910-00-436-1064	77	155
			5910-00-436-1064	77	163
			5910-00-436-1064	77	166
			5910-00-460-0847	77	119
			5910-00-471-5168	14	11
			5910-00-471-5168	15	11

SECTION IV NATIONAL STOCK NUMBER AND PART NUMBER INDEX

NATIONAL STOCK NUMBER	FIG NO.	ITEM NO.	NATIONAL STOCK NUMBER	FIG NO.	ITEM NO.
5910-00-471-5168	68	30	5910-00-667-6123	61	3
5910-00-483-5618	45	17	5910-00-667-6613	77	133
5910-00-537-5472	77	94	5910-00-668-5204	57	15
5910-00-538-7731	77	63	5910-00-668-5206	57	13
5910-00-543-0506	56	67	5910-00-668-5903	56	47
5910-00-543-0606	103	1	5910-00-668-5903	76	2
5910-00-543-9197	52	23	5910-00-668-5903	76	19
5910-00-543-9197	56	61	5910-00-681-2283	76	25
5910-00-543-9299	77	61	5910-00-681-2283	76	26
5910-00-556-9440	77	2	5910-00-681-2283	77	6
5910-00-567-2667	76	1	5910-00-681-7615	57	37
5910-00-577-3282	102	13	5910-00-681-7617	56	35
5910-00-578-1623	76	14	5910-00-688-2822	95	38
5910-00-689-8275	52	6	5910-00-691-1242	48	16
5910-00-591-2260	14	19	5910-00-712-8697	99	7
5910-00-591-2260	15	19	5910-00-712-8697	101	20
5910-00-591-2260	20	1	5910-00-721-3804	80	25
5910-00-591-2260	23	2	5910-00-725-7647	77	45
5910-00-591-2260	29	3	5910-00-725-7647	77	116
5910-00-430-8713	78	6	5910-00-726-1197	56	34
5910-00-649-5094	52	60	5910-00-726-1197	57	38
5910-00-665-0260	54	14	5910-00-726-5228	81	4
5910-00-666-6558	52	15	5910-00-727-3548	56	65
5910-00-666-7599	77	62	5910-00-727-4995	52	39
5910-00-666-7974	55	8	5910-00-762-2945	77	147
5910-00-666-7974	55	9	5910-00-762-2945	77	158
5910-00-666-7974	55	11	5910-00-762-2945	77	178
5910-00-666-7974	55	12	5910-00-772-1820	52	6
5910-00-666-8429	76	18	5910-00-775-4045	13	15
5910-00-666-8432	77	73	5910-00-775-4045	16	59
5910-00-666-8433	77	74	5910-00-775-4045	22	3
5910-00-666-8433	77	80	5910-00-775-4045	24	12
5910-00-667-4996	76	29	5910-00-775-4045	27	13
5910-00-667-5110	77	46	5910-00-775-4045	29	5
5910-00-667-5249	84	3	5910-00-775-4045	29	69
5910-00-667-5383	53	83	5910-00-775-4045	66	8
5910-00-667-6123	51	31	5910-00-781-7929	72	26
5910-00-667-6123	52	17	5910-00-783-9397	51	39
5910-00-667-6123	52	17	5910-00-787-5074	81	6
5910-00-667-6123	52	21	5910-00-805-6632	56	40
5910-00-667-6123	56	39			
5910-00-667-6123	57	34			
5910-00-667-6123	60	10			
5610-00-667-6123	61	32			

SECTION IV NATIONAL STOCK NUMBER AND PART NUMBER INDEX

NATIONAL STOCK NUMBER	FIG NO.	ITEM NO	NATIONAL STOCK NUMBER	FIG NO	ITEM NO
5910-00-806-9160	77	11	5910-00-889-4302	51	3
5910-00-806-9160	77	21	5910-00-892-7312	95	29
5910-00-807-1527	56	59	5910-00-892-9904	57	29
			5910-00-894-7163	100	37
5910-00-810-2476	56	64	5910-00-889-4975	72	18
591000-810-4848	102	8	5910-00-901-8796	57	45
5910-00-810-4849	100	14	5910-00-901-8949	78	11
			5910-00-903-6144	73	66
5910-00-810-4849	102	12	5910-00-905-2610	30	5
5910-00-814-7653	101	9	5910-00-905-6086	29	1
5910-00-820-6114	100	9	5910-00-905-6086	69	3
5910-00-821-4702	51	28	5910-00-905-6086	73	58
5910-00-821-4702	51	37	5910-00-905-6425	18	49
5910-00-821-4702	52	19	5910-00-905-6425	23	8
5910-00-821-4702	53	34	5910-00-905-6425	25	21
5910-00-821-7071	51	34	5910-00-905-6425	26	23
5910-00-821-7071	52	32	5910-00-905-6425	27	78
5910-00-823-1538	95	40	5910-00-910-6103	14	7
5910-00-825-0403	99	17	5910-00-910-6103	15	7
5910-00-825-0403	103	4	5910-00-910-6103	18	47
5910-00-825-1637	52	47	5910-00-910-6103	23	1
5910-00-826-2719	52	55	5910-00-910-6104	30	1
6910-00-832-8419	70	19			
5910-00-835-3513	52	5	5910-00-913-4473	32	6
5910-00-835-3513	56	70	5910-00-925-6106	76	4
6910-00-400-8444	62	63			
5910-00-848-8985	95	20	5910-00-925-6106	76	38
5910-00-848-8987	95	16	5910-00-932-2738	52	39
5910-00-848-8987	100	15	5910-00-932-2738	57	31
5910-00-840-8988	100	7	5910-00-932-5724	51	30
5910-00-849-3783	99	11	5910-00-932-5724	56	69
5910-00-850-0540	52	43	5910-00-932-5724	57	46
			5910-00-936-7372	88	28
5910-00-850-0540	56	68	5910-00-939-7396	13	21
5910-00-850-0540	77	217	5910-00-939-7396	16	57
5910-00-850-0540	77	218	5910-00-939-7396	23	18
5910-00-850-0541	57	30	5910-00-939-7396	27	7
5910-00-850-2234	58	127	5910-00-939-7396	29	9
5910-00-850-9074	56	50	5910-00-944-2051	105	3
5910-00-850-9074	57	28	5910-00-945-7959	27	9
5910-00-854-0519	95	3	5910-00-946-2288	14	14
5910-00-854-0566	95	25	5910-00-946-2288	15	14
5910-00-854-0568	95	2	5910-00-946-2288	26	25
5910-00-871-5935	52	38	5910-00-946-2Z88	28	23
5910-00-885-8552	48	3	5910-00-947-8247	27	74

SECTION IV NATIONAL STOCK NUMBER AND PART NUMBER INDEX

NATIONAL STOCK NUMBER	FIG NO.	ITEM NO.	NATIONAL STOCK NUMBER	FIG NO.	ITEM NO.
5910-00-947-8247	28	8	5920-00-577-2264	49	7
5910-00-952-5624	31	3	5920-00-655-3806	95	13
5910-00-952-7046	72	22	5920-00-892-9311	65	17
5910-00-954-5498	73	81	5920-00-894-2387	50	20
5910-00-954-5500	73	s9	5925-00-063-5798	108	9
5810-00-954-5504	73	28	5925-00-583-7941	108	2
5910-00-957-2058	68	24	5925-00-682-4096	108	4
5910-00-957-9909	73	73	5925-00-733-8238	108	7
5810-00-972-9420	108	4	5925-00-733-8240	108	3
5810-00-974-5589	73	71	5925-00-886-3292	108	8
5910-00-992-2473	13	26	5930-00-034-1747	61	36
5810-00-992-2473	89	13	5930-00-092-1295	77	179
5910-00-993-2380	52	48	5930-00-096-7326	77	213
5910-00-993-2380	56	37	5930-00-204-6393	61	22
5010-00-893-2380	57	47	6530-00-204-6407	56	57
5910-00-995-8615	13	28	5930-00-204-6409	56	71
5910-00-031-4562	72	16	5930-00-240-3704	4	26
5910-00-995-8615	13	28	6530-00-295-2968	52	31
6910-00-031-4682	66	14	5930-00-296-9610	85	17
5910-00-034-7993	19	7	5930-00-299-7816	83	12
5910-00-034-7994	23	9	5930-00-309-3993	76	31
5910-00-036-5107	18	17	5930-00-548-5008	52	31
5610-00-035-7993	17	13	5930-00-548-8570	61	23
5915-00-195-8761	107	2	5930-00-548-8634	77	9
5915-00-400-0844	6	4	5930-00-548-8634	79	2
5915-00-601-4054	78	35	5930-00-549-0308	39	4
5915-00-504-7560	61	1	5930-00-583-5258	61	24
5915-00-523-1960	52	42	5930-00-615-7877	37	6
5916-00-623-1961	52	40	5930-00-615-7877	98	18
5915-00-523-1962	52	40	5930-00-636-4014	4	27
5915-00-568-6241	52	38	5930-00-646-4619	85	5
5916-00-711-3887	52	37	5930-00-655-1508	81	7
5915-00-849-7500	103	20	5930-00-655-1582	37	3
5915-00-849-9072	96	22	5930-00-655-1582	92	16
5916-00-988-0955	5	1	5930-00-655-1582	98	19
5916-00-822-7556	103	19	5930-00-655-1582	104	18
5915-00-822-7575	103	18	5930-00-723-5091	39	6
5930-00-548-6607	77	83	5930-00-729-0453	10	5
5915-00-862-2757	103	18	5930-00-820-9131	49	6
6916-00-466-0100	107	3	5930-00-820-9131	96	1
5915-01-006-6310	23	15			
6915-00-882-0710	27	35			
5916-00-182-0808	26	44			
6598-01-263-8209	26	76			
5911-00-532-8210	26	72			
5816-01-115-8211	28	39			
5915-01-010-8412	27	58			
5915-01-016-2987	27	62			
5916-01-163-7078	13	58			
5915-01-016-8232	16	16			
5815-01-016-8189	22	28			
5915-01-016-8190	22	17			
5915-01-016-8233	25	16			
5851-01-016-2341	25	12			
5916-01-016-8262	29	4			
6158-01-019-8890	2	14			
5916-01-019-0810	22	28			
5916-01-019-0901	22	28			
5816-01-010-6181	43	6			
5915-01-023-1960	62	42			
5920-00-236-1815	46	2			
5692-00-606-3205	37	4			
6920-00-199-8958	45	3			
5120-00-199-4913	43	a			
9200-19-484-1218	92	13			
5892-00-199-9498	98	15			
5920-00-199-9479	104	14			
6920-00-251-7611	95	14			
5092-00-241-0187	48	6			
6920-00-280-9328	37	5			
5920-00-284-9484	48	5			
5920-00-356-2188	49	8			
5920-00-563-7116	37	14			
5620-00-553-7116	92	18			
6520-00-553-7116	98	14			
5920-00-553-7116	104	13			

Section IV NATIONAL STOCK NUMBER AND PART NUMBER INDEX

NATIONAL STOCK NUMBER	FIG NO.	ITEM NO.	NATIONAL STOCK NUMBER	FIG NO.	ITEM NO.
5930-00-841-8051	4				
5930-00-841-8051	100	36	5935-00-201-3181	91	14
5930-00-854-3135	4	25			
5930-00-923-0300	29	61	5935-00-201-4783	78	13
6930-01-006-8200	29	62			
5630-01-061-8261	29	63	5935-00-201-4783	82	8
5630-01-061-9358	29	42	5035-00-201-7122	51	11
6030-00-118-2315	29	93	5935-00-201-7922	57	25
6030-01-012-7978	29	84			
6930-01-012-7979	29	98	5935-00-201-1057	97	2
6030-01-034-8121	29	82			
6036-50-006-8811	29	78	5935-00-204-6389	50	7
9364-00-206-0448	30	3			
6036-00-881-2308	8	4	5935-00-204-6391	50	9
6936-00-106-7724	4	8			
6936-00-129-9368	37	11	5935-00-204-6910	56	32
6593-00-658-1293	92	4			
5935-00-129-9358	98	11	5935-00-204-6063	56	33
5935-00-129-9358	102	4	5935-00-222-7420	3	33
5935-00-129-9358	104	10	5935-00-222-9828	51	21
5935-00-132-2405	51	17	5935-00-222-9828	52	10
5935-00-132-2405	52	2	5935-00-222-9828	52	53
5935-00-132-2405	56	43	5935-00-222-9828	56	77
5935-00-132-2405	57	36	5935-00-222-9828	56	82
5935-00-132-2405	60	7	5935-00-222-9828	59	4
5935-00-149-4013	75	12	5935-00-222-9828	76	22A
5935-00-149-4013	112	5	5935-00-222-9828	78	12
5935-00-149-4236	4		5935-00-247-8405	44	6
5935-00-149-4236	4		5935-00-247-8406	44	4
5935-00-186-1636	0	28	5935-00-257-6397	4	1
5935-00-162-6285	4	18	5935-00-257-6397	116	3
5935-00-163-0004	49	5	5935-00-257-8546	37	9
5935-00-171-3006	3	32	5935-00-257-8546	98	4
5935-00-173-7748	102	2	5935-00-257-8546	104	19
5935-00-173-7748	103	17	5935-00-257-8996	36	3
5935-00-186-9868	4		5935-00-258-1270	4	5
5935-00-186-9868	4		5935-00-258-1270	113	3
5935-00-192-4729	29	44	5935-00-259-3313	4	11
5935-00-192-4774	4		5935-00-259-3318	61	1
5835-00-259-3323	4				
5935-00-192-4774	4	23	5935-00-259-3336	4	13
5935-00-264-5932	51	7			
5935-00-192-4808	38	2	5935-00-280-2017	85	2
5935-00-192-4808	90	2	5935-00-283-3826	2	2
5935-00-192-4809	97	3	5935-00-283-3826	98	2
5935-00-192-4812	91	15	5935-00-283-3826	99	22
5935-00-192-4882	4				
5935-00-192-4882	4	22	5935-00-283-3826	104	2
5935-00-192-4883	114	5	5935-00-283-7096	83	14
5935-00-194-3079	90	3	5935-00-286-2598	104	17
			6365-00-296-5006	51	13

Section IV NATIONAL STOCK NUMBER AND PART NUMBER INDEX

NATIONAL STOCK NUMBER	FIG NO.	ITEM NO.	NATIONAL STOCK NUMBER	FIG NO.	ITEM NO.
5935-00-295-5361	75	9	5935-00-636-7145	98	6
5935-00-295-5361	112	2	5935-00-636-7145	104	5
5935-00-404-7965	4		5935-00-644-5121	83	9
5935-00-404-7965	4		5935-00-646-5890	37	8
5935-00-404-7965	7	1	5935-00-646-5890	92	1
5935-00-404-7965	8	1	5935-00-646-5890	98	1
5935-00-404-7965	36	1	5935-00-646-5890	104	1A
5935-00-451-2449	118	8	5935-00-646-5908	39	9
5935-00-470-9267	43	7	5935-00-646-5908	41	2
5935-00-470-9267	45	1	5935-00-660-4302	4	
5935-00-481-4486	29	13	5935-00-660-4302	4	
5935-00-493-6288	115	16	5935-00-660-5590	52	20
5935-00-501-7594	4	4	5935-00-681-5685	75	6
5535-00-501-7594			5935-00-681-5685	115	8
5935-00-539-2045	95	43	5935-00-683-2746	61	39
5995-00-539-2045	99	23			
5935-00-539-5944	100	31	5935-00-686-0311	47	1
5935-00-722-7845	86	3			
5935-00-542-9821	95	4	5935-00-754-8787	61	9
5936-00-552-7613	95	45	5935-00-779-8426	100	27
5935-00-552-7613	100	30	5935-00-804-0664	6	3
5935-00-552-7613	101	1	5935-00-810-7514	56	1
5935-00-552-7978	92	3	5935-00-813-0620	4	6
5935-00-552-7978	93	1	5935-00-813-0620	116	1
5935-00-552-1978	98	3	5935-00-815-4721	38	1
5935-00-552-7978	104	3	5935-00-815-4721	47	2
5935-00-553-3181	92	7	5935-00-815-4721	90	1
5935-00-553-3181	93	4	5935-00-815-4721	91	13
5935-00-815-4721	97	3			
5935-00-553-3181	93	5	5935-00-823-0308	10	1
5935-00-553-3181	95	11	5935-00-826-4998	111	1
5935-00-830-1508	10	2			
5935-00-553-3181	98	5	5935-00-835-0508	29	110
5935-00-553-3181	99	29	5935-00-835-0510	29	83
5935-00-553-3181	100	21	5935-00-835-0510	65	2
5935-00-553-3181	101	12	5935-00-850-2250	52	16
5935-00-553-3181	104	4	5935-00-850-2250	57	12
5935-00-636-5913	57	18	5935-00-850-9157	118	7
5935-00-636-5918	29	87	5935-00-851-5699	4	7
5935-00-636-5918	65	3	5935-00-852-9150	30	2
5935-00-853-7596	79	20			
5935-00-636-7157	37	2	5935-07-544-1254	37	1
5935-85-654-2527	104	1			
5935-00-636-7145	92	11	5935-00-857-6547	92	12

Section IV NATIONAL STOCK NUMBER AND PAR.T NUMBER INDEX

NATIONAL STOCK NUMBER	FIG NO.	ITEM NO.	NATIONAL STOCK NUMBER	FIG NO.	ITEM NO.
5935-00-857-6547	98	20	5940-00-552-4518	96	10
5935-00-858-8243	6	1	5940-00-552-4518	113	1
5935-00-874-3424	4	9	5940-00-577-6076	3	30
6935-00-879-1133	77	131			
5935-00-885-6006	111	4	5940-00-577-7076	3	43
5935-00-885-6007	111	3	5940-00-636-5485	98	21
5935-00-885-8621	4	1	5940-00-836-8557	117	1
5935-00-886-3251	49	9	5940-00-983-6059	104	20
5935-00-886-3252	4	4	5940-00-983-6084	83	5
5935-00-892-9069	6	2	5940-00-983-6127	83	8
5935-00-903-9778	56	2	5940-00-983-6127	83	11
5935-00-377-2418	60	1			
6036-00-011-5615	115	7	5940-00-983-6129	61	2
5935-00-919-5135	79	19			
5935-00-935-2231	51	19	5940-09-213-5852	77	160
5935-00-959-4929	14	6	5945-00-204-6392	51	1
5935-00-959-4929	15	6	5945-00-236-4708	87	5
S935-55-279-7859	93	8	5945-00-518-9836	49	4
5940-00-049-7836	77	75	5945-00-615-1457	102	3
5940-00-092-1354	77	37	5945-00-852-0465	92	5
5940-00-092-1364	77	150	5945-00-852-0465	98	10
5940-00-092-1365	77	64	5945-00-852-0465	104	9
5940-00-092-1372	77	107	5945-00-887-0760	102	1
S940-00-092-1373	77	55	5945-00-893-7375	37	10
5940-00-092-1374	77	87	5945-00-905-3933	29	109
5940-00-092-1375	77	41	5945-00-912-1809	96	8
5940-00-159-0245	13	4	5950-00-003-4725	13	61
5940-00-159-0245	14	10	5950-00-003-4725	16	61
5940-00-159-0245	15	10	5950-00-003-4725	17	47
5940-00-159-0245	16	8	5950-00-003-4725	19	42
5940-00-159-0245	17	39	5950-00-003-4725	22	50
5940-00-159-0245	18	9	5950-00-053-8245	56	81
5940-00-159-0240	19	2	5950-00-060-4120	103	16
5940-00-159-0245	22	8	5950-00-295-7304	51	8
5940-00-159-0245	23	5	5950-00-344-1863	14	35
5940-00-159-0245	27	2	5950-00-344-1863	15	34
5940-00-159-0245	69	1	5950-00-344-1863	17	49
5940-00-204-8023	87	4	5950-00-344-1863	18	21
5940-00-223-5293	5	2	5950-00-344-1863	19	39
5940-00-283-5393	5	3	5950-00-344-1863	20	31
5940-00-542-9890	58	4	5950-00-344-1863	23	3
5940-00-549-9352	96	6	5950-00-344-1863	24	15

Section IV

NATIONAL STOCK NUMBER AND PART NUMBER INDEX

NATIONAL STOCK NUMBER	FIG NO.	ITEM NO.	NATIONAL STOCK NUMBER	FIG NO.	ITEM NO.
5950-00-344-1863	25	11	5950-00-698-1986	56	3
5950-00-344-1863	26	56	5950-00-704-1993	56	46
5950-00-344-1863	27	41	5950-00-704-1993	57	42
5950-00-344-1863	28	24	5990-00-744-9895	29	71
5950-00-344-1863	29	2	5950-00-755-4163	95	4
5950-00-344-1863	30	4	5950-00-831-2825	51	4
5950-00-387-0489	52	24	5950-00-851-4221	99	28
5950-00-387-0489	56	66	5950-00-851-4221	101	3
5950-00-462-7365	65	23			
5950-00-510-1672	59	1	5950-00-854-0494	92	8
5950-00-510-1744	56	6	5950-00-854-0494	98	8
5950-00-510-1745	56	13	5950-00-885-5883	48	7
5950-00-510-1746	56	17	5950-00-885-5885	48	13
5950-00-510-1747	56	27	5950-00-885-5886	48	15
5950-00-510-1748	56	24	5950-00-187-1794	27	60
5950-00-510-1749	56	25	5950-00-914-1928	66	22
5950-00-510-1750	56	29	5950-00-006-8295	14	32
5950-00-510-1771	51	5	5950-00-006-8296	14	37
5950-00-510-7678	52	13	5950-00-006-8297	15	37
5950-00-523-8388	54	2	5950-00-006-8298	15	38
5950-00-523-8431	56	11	5950-00-006-8299	23	41
5950-00-523-8431	57	11	5950-00-006-8300	23	28
5950-00-523-8432	56	23	5950-01-006-8301	24	31
5950-00-537-4983	56	18	5950-01-006-8302	26	51
5950-00-537-5124	56	14	5950-01-006-8303	27	25
5950-00-537-5125	54	17	5950-01-006-8304	28	29
5950-00-523-5125	55	21	5950-01-006-8305	27	32
5950-00-567-2579	51	6	5950-01-006-8306	18	63
5950-00-627-3107	25	10	5950-01-007-1799	13	71
5950-00-645-6869	76	7	5950-01-008-2487	20	16
5950-00-647-8096	56	5	5950-01-008-2488	25	79
5950-00-647-9191	52	25	5950-01-008-2489	16	25
5950-00-671-5208	20	2	5950-01-008-2490	23	49
5950-00-671-5208	20	37	5950-01-008-8626	23	21
5950-00-671-5208	29	77	5950-01-008-8628	24	4
5950-00-698-0226	56	3A	5950-01-008-8671	24	58
5950-00-698-0226	56	6A	5950-01-008-8671	26	46
5950-00-698-1253	52	41	5950-01-009-9034	24	31
5950-00-698-1978	56	15	5950-01-009-7526	26	20
5950-00-698-1981	56	16	5950-01-011-8032	20	35
5950-00-698-1984	56	28	5950-01-012-4990	26	46
			5950-01-015-8239	30	40
			5950-01-016-8208	26	49
			5950-01-017-0209	20	44
			5950-01-017-1791	26	8
			5950-01-017-1792	30	15
			5950-01-017-8253	26	73
			5950-01-017-3657	24	36
			5950-01-034-8136	25	4
			5950-01-034-8141	28	18
			5950-01-034-8141	28	3
			5950-01-034-9325	69	8
			5950-01-034-3326	68	22
			5950-01-034-9327	73	8
			5950-01-034-9328	73	21
			5950-01-034-9329	67	9
			5950-01-034-9330	72	10
			5950-01-034-9334	73	1
			5950-01-034-9652	24	6
			5950-01-034-9330	73	6
			5950-01-034-9334	72	39

SECTION IV NATIONAL STOCK NUMBER AND PART NUMBER INDEX

NATIONAL STOCK NUMBER	FIG NO.	ITEM NO	NATIONAL STOCK NUMBER	FIG NO	ITEM NO
5950-01-034-9335	68	20			
5950-01-034-9337	73	9			
5950-01-034-9338	68	16			
5950-01-035-7457	67	11			
5950-01-035-3657	66	10			
5950-01-035-5199	73	5			
5950-01-035-6227	24	27			
5950-01-035-9324	69	7			
5950-01-035-9331	73	16			
5950-01-035-9580	69	12			
5950-01-035-9582	69	17			
5955-00-087-063	57	3			
5955-00-267-4196	57	1			
5955-00-459-4247	73	37			
5955-00-459-4251	73	27			
5955-00-459-4252	73	39			
5955-00-459-4253	73	41			
5955-00-459-4273	73	36			
5955-00-518-4601	57	40			
5955-00-694-1090	57	24			
5955-00-813-7545	57	21			
5955-00-881-9363	57	10			
5955-00-889-3917	57	5			
5955-00-892-3603	57	22			
5955-00-892-3604	57	20			
5955-00-951-9019	57	9			
5955-00-951-9029	57	8			
5955-00-984-0320	57	4			
5955-01-035-5224	14	24			
5955-01-035-5225	14	20			
5955-01-035-5229	15	24			
5955-01-035-5226	14	17			
5955-01-035-5227	14	9			
5955-01-035-5231	15	20			
5955-01-035-5232	15	17			
5955-01-035-5233	15	9			
5955-01-036-5585	14	23			
5955-01-035-5235	22	37			
5960-00-027-1732	82	2			
5960-00-082-4139	76	15			
5960-00-134-6004	54	5			
5960-00-134-6031	56	9			
5960-40-134-6031	57	19			
5960-00-179-3252	82	3			
5960-00-179-3710	76	13			

Section IV. NATIONAL STOCK NUMBER AND PART NUMBER INDEX

<u>NATIONAL STOCK NUMBER</u>	<u>FIG. NO.</u>	<u>ITEM NO.</u>	<u>NATIONAL STOCK NUMBER</u>	<u>FIG. NO.</u>	<u>ITEM NO.</u>
5960-00-179-3710	82	5	5691-00-148-8976	29	77
5960-00-188-0806	76	22	5661-00-168-2887	18	50
5960-00-188-3551	51	7	5961-00-170-4430	13	41
5960-00-188-3551	54	1	5961-00-170-4430	16	16
5960-00-188-3564	51	10	5961-00-199-6008	65	30
5960-00-262-0210	51	9	5961-00-401-0507	26	2
5960-00-262-0210	54	4	5961-00-462-1814	71	6
5960-00-262-0210	56	10	5961-00-468-3661	18	62
5960-00-262-0210	76	3	5961-00-469-2216	18	62
5960-00-262-0221	59	2	5961-00-566-0973	66	4
5960-00-262-0286	82	4	5961-00-577-6084	100	8
5960-00-264-2089	54	5	5961-00-677-6214	39	7
5960-00-354-0552	99	6	5961-00-586-5131	20	7
5960-00-577-6084	103	3	5961-00-615-0095	99	27
5960-00-577-6135	60	4	5961-00-686-6720	20	20
5960-00-581-8619	100	16	5961-00-715-1051	45	12
5960-00-729-6963	76	10	5961-00-752-6121	32	4
5960-00-731-1234	95	9	5961-00-826-0053	48	4
5960-00-731-1234	99	9	5961-0-829-0194	70	22
5960-00-731-1234	100	18	5961-00-840-3521	16	19
5960-00-731-1234	101	2	5961-00-847-8246	13	8
5960-00-752-6136	103	10	5961-00-850-9501	132	18
5960-00-754-5897	100	20	5961-00-852-7549	16	26
5960-00-852-7549	100	32	5961-00-852-7549	99	8
5960-00-854-0552	99	30	5961-00-853-2607	50	72
5960-00-854-0552	100	3	5961-00-853-2607	61	14
5960-00-854-0552	101	6	5861-00-855-1551	70	25
5960-00-854-0552	102	10	5961-00-879-3091	16	43
5960-00-854-0552	103	12	5961-00-880-8598	48	10
5960-00-879-5078	76	17	5961-00-901-4862	32	2
5960-00-868-3361	23	52	5961-00-924-4304	63	10
5960-00-899-6822	48	11	5961-00-939-4226	20	46
5960-00-985-8987	56	26	5962-00-081-0977	16	46
5961-00-022-5664	16	54	5962-00-106-4282	73	19
5961-00-022-5664	18	61	5962-00-106-9344	17	30
5961-00-022-5664	24	7	5962-00-106-9344	19	41
5961-00-022-5664	26	18	5962-00-106-9344	20	11
5961-00-022-5664	27	43	5962-00-115-3560	17	19
5961-00-022-5664	66	2	5962-00-115-7953	17	32
5961-00-054-0046	16	23	5962-00-115-7953	19	33
			5962-00-115-7953	26	37
			5962-00-141-0743	17	31
			5962-00-141-0743	19	38
			5962-00-141-0743	23	51
			5962-00-141-0743	25	24
			5962-00-162-7505	66	6
			5962-00-172-5578	73	18
			5962-00-229-8500	73	16
			5962-00-250-4824	73	15
			5962-00-274-4122	73	60
			5962-00-341-0544	66	26
			5962-00-348-2718	66	27
			5962-00-481-9523	17	45
			5962-00-481-9523	19	44

Section IV. NATIONAL STOCK NUMBER AND PART NUMBER INDEX

NATIONAL STOCK NUMBER	FIG. NO.	ITEM NO.	NATIONAL STOCK NUMBER	FIG. NO.	ITEM NO.
5962-00-481-9677	18	59			
5962-00-481-9677	73	12	5995-00-725-5484	91	11
5962-00-566-0973	66	4			
5962-00-837-7276	13	7			
5962-00-995-2310	17	48			
5962-00-995-2310	19	40	5995-00-876-2357	4	14
5965-00-874-6941	48	1	5995-00-889-0590	115	3
5970-00-198-6388	3	6	5995-00-889-0600	3	21
5970-00-295-7617	3	22	5995-00-889-0601	3	5
5970-00-475-2499	3	19	5995-00-889-0602	111	5
5970-00-953-4907	3	16	5995-00-913-0509	118	5
5970-00-954-5130	3	17	5995-00-926-3373	75	4
5970-00-995-9288	3	42	5995-00-926-3373	115	1
5975-00-223-4627	3	37	5995-00-933-5800	118	4
5975-00-246-0707	3	29	5995-00-933-5802	118	6
5975-00-257-1230	3	41	5996-00-956-4398	116	2
			5996-00-035-5229	15	24
5975-00-475-2407	4	3	5996-00-035-5236	23	34
			6096-01-036-5234	23	40
5975-00-475-2409	4	16	5996-01-036-5237	23	9
			5699-01-035-7467	67	11
5975-00-875-1295	3	34	5095-01-036-7458	68	11
			5095-01-356-7458	73	26
5975-00-886-3265	4	2	5095-01-356-7460	73	42
			5995-01-036-7451	3	28
5985-00-034-5268	62	1A	6996-01-459-4273	13	36
			5999-01-351-5788	20	55
5985-00-252-1733	3	1	5999-01-035-5789	29	106
5985-00-937-0780	3	55	6106-01-180-0736	106	3
6000-01-034-8298	26	R1	6106-00-857-2793	84	11
5999-00-070-8747	115	6	6130-00-002-8804	45	15
5995-00-161-8737	114	3	6130-00-548-0067	61	16
5995-00-164-6548	112	3	6145-00-059-8771	39	10
5995-00-170-4868	114	2	6145-00-059-8771	41	3
5995-00-170-6879	114	1	6145-00-129-9320	3	36
			6145-00-161-0885	3	26
5995-00-170-6887	4	15			
5995-00-221-9450	118	2			
			6145-00-161-0885	36	2
			6145-00-161-0885	BULK	
5995-00-456-2002	115	5			
5995-00-490-1028	115	7			
			6145-00-161-0887	BULK	
5995-00-538-9030	75	17	6145-00-161-0913	BULK	
5995-00-538-9030	115	11	6145-00-170-7829	3	11
5995-00-570-5688	91	10	6145-00-195-0400	3	14
5995-00-636-0120	11	2	6145-00-350-3497	43	8
5995-00-681-8482	115	4	6145-00-350-3497	45	4
5995-00-686-4284	75	13			
5995-00-686-4284	112	4			
			6146-00-542-8092	BULK	

Section IV. NATIONAL STOCK NUMBER AND PART NUMBER INDEX

NATIONAL STOCK NUMBER	FIG. NO.	ITEM NO.	NATIONAL STOCK NUMBER	FIG. NO.	ITEM NO.
6145-00-542-6092	75	5			
6145-00-542-6092	115	9	6625-00-456-3113		13
6145-00-542-6682	77	8			
6145-00-838-1384	111	2			
6145-00-857-6903	3	31			
6210-00-028-0043	4	21			
6210-00-030-2444	39	3			
6210-00-030-2444	44	1			
6210-00-030-2444	96	4			
6210-00-169-4108	77	86	6625-00-669-0769	61	17
6210-00-186-7916	39	1	6625-00-669-0169	75	1
6210-00-186-7916	44	2			
8825-00-783-6145	68	46			
6210-00-186-7916	96	2			
6210-00-186-7987	77	85	6625-00-827-4651	75	2
8210-00-553-7437	81	11			
6210-00-752-1233	108	6	6625-00-857-5299	100	34
6210-00-851-6307	37	13	6625-00-892-5623	99	19
6210-00-851-6307	92	15			
6210-00-851-6307	98	17	6645-00-892-4369	40	1
6210-00-851-6307	104	16	6680-00-752-8255	58	74
6210-00-862-2764	103	21	8130-00-656-1090	3	38
6240-00-155-7836	29	34	8515-00-702-0733	85	14
6240-00-155-8706	75	10	- - -		
6240-00-155-8706	75	15	- - -		
6240-00-155-8706	75	16	- - -		
6240-00-155-8706	96	3	- - -		
6240-00-179-1814	108	5	- - -		
6240-00-223-9100	37	12	- - -		
6240-00-223-9100	39	2	- - -		
6240-00-223-9100	44	3	- - -		
6240-00-223-9100	92	14	- - -		
6240-00-223-9100	98	16	- - -		
6240-00-223-9100	104	15	- - -		
6240-00-763-7744	4	20	- - -		
6240-00-851-4352	65	11	- - -		
6240-00-886-3256	41	1	- - -		
6240-00-892-4420	65	9	- - -		
6260-01-024-0233	27	87	- - -		
6350-00-000-8978	39	5	- - -		
6625-00-059-8704	89	3	- - -		
6625-00-18-2910	114	4	- - -		

Section IV. NATIONAL STOCK NUMBER AND PART NUMBER INDEX

PART NUMBER	FSCM	FIG ITEM		PART NUMBER	FSCM	FIG ITEM	
		NO.	NO.			NO.	NO.
A8746G	82679	3	1	BMA173	82679	29	106
A8746G	82679	3	56	BMA509	82679	65	21
AB998	82679	3	55				
AMU13WA	90095	27	60	BMA510	82679	65	19
ANFTA28	82679	1	18				
ANFTA28	82679	47	991				
ANGFC161X	82679	44	991				
ANFGC161X	82679	1	16				
				BR1000-50V	09023	71	1
				BX222	82679	27	90
				BX223	82679	27	94
ANURA36A	82679	1	2				
AN931A3-5	06540	88	4	BX224	82679	27	98
AS129	82679	29	66	BX227	82679	25	29
AS130	82679	29	100	BX228	82679	25	33
AS131	82679	29	91	BZE6-2RQ81	15906	4	25
AS132	82679	29	41				
AX745	82679	63	3	CAP	82679	5	3
				CA1364	82679	29	59
AX746	82679	63	18				
				CA1377	82679	29	74
A0121	82679	30	13				
				CA1394	82679	29	80
A102	81679	3	8				
A1174	81349	46	7	CA1710	82679	10	9
A1176	82679	3	8				
A4475	82879	17		CA1725	82679	63	1
A4478	82679	24					
A4480	82679	23		CA1725	82679	63	6
A4487	82679	19					
A4500	826879	14		CA1727	82679	87	1
A4501	82679	15					
A4502	82679	20		CA1732	82679	65	31
A4504	82679	25					
A4506	82679	27		CA1733	82679	65	32
A4512	82679	31					
A4524	82679	22		CA1734	82679	65	33
A4525	82679	16					
A4526	82679	13		CA3040	02735	67	20
A4563	82679	33					
A4592	82879	29	47	CA480-174-17	82679	63	2
A4593	82679	29	27				
A4751	82679	88		CA480-174-17	82679	63	4
A4928	82679	8	30				
A4929	82679	9	42	CA480-174-17	82679	63	15
A4932	82679	6	7				
A4947	82679	86	26	CA480-174-42	82679	87	2
A4948	82679	63	20				
				CA480-174-42	82679	88	1
				CA480-5-600	82679	10	8
A967-15	20825	3	19				
BG200-73EX100KC	03040	76	12				
BMA100	82679	11	3				
BMA100	82679	29	32				
BMA101	82879	29	31				
BMA103	82679	29	23				
BMA104	82679	29	90				
BMA151	82679	30	14				

Section IV. NATIONAL STOCK NUMBER AND PART NUMBER INDEX

PART NUMBER	FSCM	FIG ITEM		PART NUMBER	FSCM	FIG ITEM	
		NO.	NO.			NO.	NO.
CA581-2	82679	115	14	CE41C250Q	81349	81	9
CB21QB102K	82679	29	75	CE42C300Q	81349	76	4
CB845	04213	76	20	CE42C300Q	81349	76	38
CB846	04213	76	16	CE42C450J	81349	76	36
CB847	04213	76	9	CE52C450N	81349	51	3
CB847	04213	76	11	CE53C300N	81349	51	2
CB848	04213	76	7	CE61C060Q	81349	77	62
CB849	04213	76	24	CE63C060Q	81349	77	61
CB850	04213	77	164	CE63C200J	81349	77	63
CB851	04213	77	204	CE64C500G	81349	61	11
CC100-40	82679	13	62	CF105-06	95566	20	26
CC100-40	82679	16	49	CF105-06	95566	24	41
CC100-40	82679	18	54	CF105-06	95566	27	53
CC100-40	82679	19	43	CG409EU	82679	75	4
CC100-40	82679	24	5	CG409EU	82679	115	1
CC100-40	82679	27	10	CG409EU	82679	115	2
CC100-41	82679	13	3	CG409EU	82679	15	3
CC100-41	82679	16	1	CG409G	82679	15	4
CC100-41	82679	17	28	CG409G	82679	115	5
CC100-41	82679	22	39	CG409G	82679	115	6
CC100-41	82679	29	6	CG409G	82679	115	7
CC20CH010C	81349	56	51	C1136-5	82679	13	16
CC20CH040C	81349	56	34	C1136-5	82679	13	19
CC20CH040C	81349	57	38	C1136-5	82679	13	46
CC20CH080C	81349	56	59	C1136-5	82679	14	33
CC20CKR75C	81349	56	36	C1136-5	82679	15	32
CC20CKOR5C	81349	56	40	C1136-5	82679	16	6
CC20CK020C	81349	56	35	C1136-5	82679	22	11
CC20CK1R5C	81349	56	67	C1136-5	82679	23	29
CC20UJ120J	81349	57	37	C1136-6	82679	13	56
CC35UJ151G	81349	77	133	C1136-6	82679	17	37
C0D135A	80063	114	1	C1136-6	82679	18	6
C0370	82679	75	13	C1136-6	82679	19	6
C0370	82679	112	4	C1136-6	82679	24	21
				C1136-6	82679	26	50
CE13C240Q	81349	105	3	C1136-6	82679	27	20
CE223277	98230	5	4	C1136-6	82679	27	65
				CKS08X102K	80063	53	28
				CK06BX104M	81349	77	119
				CK06BX184K	81349	50	18
CE41C250Q	81349	80	25	CL24-5R6	82679	20	40
				CL412-23	82679	27	79

Section IV. NATIONAL STOCK NUMBER AND PART NUMBER INDEX

PART NUMBER	FSCM	FIG ITEM		PART NUMBER	FSCM	FIG ITEM	
		NO.	NO.			NO.	NO.
CL412-24	82679	27	58	CM111E02F1S	81349	69	37
CL412-25	82679	27	62	CM111E102J1S	81349	68	17
CL412-36	82679	26	35	CM111E111J1S	81349	63	33
CL412-37	82619	26	44	CM111E111J1S	81349	73	62
CL412-38	82679	26	76	CM111E120J1S	81349	68	28
CL412-39	82679	26	12	CM111E121G1S	81349	72	30
CL412-40	82679	26	69	CM111E121J1S	81349	73	68
CL412-41	82679	26	39	CM111E121J1S	81349	74	19
CL419	82679	23	15	CM111E131F1S	81349	67	16
CL481	82679	66	10	CM111E131G1S	81349	72	33
CL482-1	82679	69	17	CM111E131J1S	81349	73	64
CL482-2	82679	69	14	CM111E132G1S	81349	72	13
CL65CM080KP3	81349	51	39	CM111E151G1S	81349	72	34
CM0CD100D03	56289	77	165				
CM04FA331J03	81349	77	159	CM111E151J1S	81349	73	69
CM111C050D5S	81349	16	47				
CM111C050D5S	81349	17	4	CM111E161J1S	81349	73	67
CM111C050D5S	81349	18	4	CM111E181G1S	81349	72	21
CM111C050D5S	81349	19	9	CM111E181J1S	81349	73	61
CM111C050D5S	81349	24	3	CM111E201J1S	81349	73	63
CM111C050D5S	81349	26	16	CM111E221G1S	81349	72	16
CM111C050D5S	81349	27	6	CM111E221J1S	81349	73	72
CM111C100J5S	81349	14	12	CM111E221J1S	81349	74	24
CM111C100J5S	81349	15	12	CM111E241J1S	81349	68	10
CM111C100J5S	81349	26	12	CM111E241J1S	81349	74	17
CM111C120J5S	81349	17	16	CM111E270J5S	81349	26	1
CM111C120J5S	81349	18	43	CM111E271J1S	81349	73	74
CM111C120K5S	81349	19	24	CM111E300G1S	81349	72	35
CM111C180J5S	81349	26	4	CM111E301J1S	81349	73	76
CM111C180J5S	81349	27	1	CM111E330G5S	81349	27	86
CM111C200J5S	81349	23	4	CM111E330J1S	81349	68	24
CM111C201J5S	81349	18	53	CM111E331J1S	81349	68	9
CM111C220J5S	81349	22	48	CM111E331J1S	81349	73	70
CM111C220J5S	81349	27	81	CM111E360J5S	81349	26	9
CM111E030J1S	81349	73	71	CM111E361G1S	81349	72	24
CM111E050D1S	81349	72	40	CM111E391J1S	81349	73	73
CM111E100D1S	81349	72	31	CM111E470G1S	81349	72	32
CM111E101F1S	82679	67	18	CM111E470G5S	81349	24	8
CM111E101F1S	81349	26	8	CM111E470G5S	81349	27	73
CM111E101J1S	81349	69	33	CM111E470G5S	81349	28	22
CM111E101J1S	81349	73	65	CM111E471F1S	82679	67	10

Section IV. NATIONAL STOCK NUMBER AND PART NUMBER INDEX

PART NUMBER	FSCM	FIG ITEM		PART NUMBER	FSCM	FIG ITEM	
		NO.	NO.			NO.	NO.
CM111E471J1S	81349	73	54	CM111F221G5S	81349	17	2
CM111E471J1S	81349	74	10	CM111F221G5S	81349	18	2
CM111E510G1S	81349	72	15	CN111F221G5S	81349	23	10
CM111E510G1S	81349	27	77	CM111F221J5S	81349	19	8
CM111E560G1S	81349	72	22	CM111F241J5S	81349	29	57
CM111E561J1S	81349	73	75	CM111F271F5S	81349	18	14
CM111E620G1S	81349	72	18	CM111F271F5S	81349	23	6
CM111E680F5S	81349	27	84	CM111F271J5S	81349	29	72
CM111E680J5S	81349	24	14	CM111F321D5S	81349	23	9
CM111E750G1S	81349	72	9	CM111F330J5S	81349	63	11
CM111E750J5S	81349	26	11	CM111F331G5S	81349	16	17
				CM111F331J5S	81349	63	8
CM111E750J5S	81349	27	88	CM111F361F5S	81349	13	54
CM111E820F5S	81349	23	13	CM111F361G5S	81349	16	4
CM111E820F5S	81349	26	14	CM111F361G5S	81349	27	15
CM111E821J1S	81349	69	28	CM111F391F5S	81349	27	14
CM111E821J1S	81349	73	77	CM111F431GS5	81349	23	11
CM111E910G1S	81349	72	26	CM111F431G5S	81349	63	35
CM111F101G5S	81349	27	11	CM111F471J5S	81349	25	25
CM111F101J5S	81349	23	16	CM111F511C5S	81349	27	12
CM111F102J1S	81349	29	53	CM111F511G5S	81349	63	16
CM111F111J5S	81349	26	13	CM111F561F5S	81349	27	12A
CM111F111J5S	81349	27	5	CM111F621D5S	81349	20	36
CM111F111J5S	81349	28	26	CM111F621D5S	81349	24	10
CM111F121G5S	81349	24	4	CM111F621D5S	81349	26	22
CM111F131G5S	81349	17	12	CM111F751G5S	81349	27	87
CM111F131G5S	81349	18	41	CM111F820J5S	81349	25	26
CM111F131G5S	81349	27	16	CM111F910J5S	81349	26	3
				CM112E152J1S	81349	73	57
CM111F131J5S	81349	19	22	CM112E153F1S	81349	69	34
CM111F131J5S	81349	26	6	CM112E162J1S	81349	73	66
CM111F131J5S	81349	29	54	CM112E182J1S	81349	73	59
CM111F151F5S	81349	22	40	CM112E252J1S	81349	66	20
CM111F151F5S	81349	24	9	CM112F103F1S	81349	73	55
CM111F151J5S	81349	29	56	CM112F112G5S	81349	20	42
CM111F161J3S	81349	29	55	CM112F122F5S	81349	19	3
CM111F181G5S	81349	17	10	CM112F122J5S	81349	17	27
CM111F181G5S	81349	19	31	CM112F122J5S	81349	18	1A
CM111F181G5S	81349	23	17	CM112F132F15	82679	70	19
CM111F181G5S	81349	26	20	CM112F152D5S	81349	17	13
CM111F181J5S	81349	29	73	CM112F152E5S	81349	18	17

Section IV. NATIONAL STOCK NUMBER AND PART NUMBER INDEX

PART NUMBER	FSCM	FIG ITEM		PART NUMBER	FSCM	FIG ITEM	
		NO.	NO.			NO.	NO.
CM112F152F5S	81349	19	17	CM15C560GN3	81349	57	45
CM112F152G5S	81349	15	39	CM15C680GN3	81349	51	30
CM112F182F1S	81349	68	18	CM15C680GN3	81349	56	69
CM112F182G5S	81349	14	8	CM15C680GN3	81349	57	46
CM112F202F1S	81349	69	39	CM15C820GN3	81349	57	31
CM112F202F1S	81349	70	17	CM15C820GO3	81349	52	39
CM112F202G5S	81349	15	8	CM15C820GO3	81349	53	36
CM112F222F5S	81349	15	16	CM15C820GO3	81349	54	8
CM112F222G5S	81349	20	43	CM15C820GO3	81349	55	7
CM112F242G5S	81349	14	16	CM15E101J	81349	77	118
CM112F27205S	81349	23	20	CM15E101JN3	81349	77	110
CM112F272F1S	82679	70	24	CM15E300J	81349	78	11
CM112F272F5S	81349	14	21	CM15E330J	81349	77	102
CM112F332F5S	81349	15	23	CM15E331J	81349	77	36
CM112F392F5S	81349	13	13	CM15E331J	81349	77	202
CM112F392F5S	81349	22	13	CM15E331JN3	81349	77	154
CM112F392G35	81349	14	31	CM15E430J	81349	78	1
CM15B108KN3	81349	57	48	CM15E471J	81349	77	147
CM15B120KN3	81349	52	48	CM15E471J	81349	77	158
CM15B120KN3	81349	53	47	CM15E471J	81349	77	178
CM15B120KN3	81349	56	37	CM15E500J	81349	77	217
CM15B120KN3	81349	57	47	CM15E500J	81349	77	218
CM15C200J03	81349	56	65	CM15E511J	81349	77	176
CM15C050K	81349	80	9	CM15E511J	81349	77	224
CM15C120J	81349	78	6	CM15E511J	81349	78	5
CM15C120J	81349	80	10	CM15E511JN3	81349	77	109
CM15C220J	81349	77	45	CM15E511JP3	81349	79	15
CN15C220J	81349	77	116	CM15E5115	81349	77	216
CM15C330JN3	81349	56	50	CM15E680J	81349	78	8
CM15C330JN3	81349	57	28	CM15E820JN3	81349	77	115
CM15C390JN3	81349	57	29	CM15F101GN3	81349	52	28
CM15C470GN3	81349	52	4	CM1SF101GN3	81349	53	3
CM15C470GN3	81349	52	7	CM15F101GN3	81349	56	72
CM15C470JN3	81349	57	30	CM15F101GN3	81349	57	32
CM15C510GN3	81349	52	43	CM15F121GN3	81349	57	33
CM15C510GN3	81349	53	42	CM1SF151GN3	81349	52	67
CM15C510GN3	81349	54	12	CM15F151GN3	81349	56	84
CM15C510GN3	81349	55	16	CM15F151GN3	81349	57	35
CM15C510GN3	81349	56	68	CM15F181GN3	81349	52	6

Section IV. NATIONAL STOCK NUMBER AND PART NUMBER INDEX

PART NUMBER	FSCM	FIG ITEM		PART NUMBER	FSCM	FIG ITEM	
		NO.	NO.			NO.	NO.
CM15F181GN3	81349	53	6	CP70B1EF805K	81349	81	6
CM15F201GN3	81349	56	74	CRLACS9-102U	71590	105	1
CM15F221GN3	81349	53	5	CR109-100	82679	14	5
CM15F221GN3	81349	56	76	CR109-101	82679	15	5
CM15F241GO3	81349	77	122	CR109-104	82679	23	40
CM15F621GP3	81349	77	125	CR109-124	82679	23	37
CM15F621GP3	81349	79	18	CR109-124	82679	26	67
CM25E102J	80063	52	15	CR109-134	82679	23	34
CM25E102J	80063	53	15	CR109-138	82679	23	39
CM25E821GN3	81349	77	108	CR109-141	82679	68	11
CM30E102GN1	81349	77	126	CR109-90	82679	14	24
CN11-1RO	82679	69	3	CR109-91	82679	15	24
CN127AR22	82679	69	15	CR109-92	82679	14	23
CN127AR47	82679	69	16	CR109-93	82679	15	22
				CR109-94	82679	14	20
CP05A1KB104K	81349	95	38	CR109-95	82679	15	20
CP05A1KB154K	81349	95	29	CR109-96	82679	14	17
CP05A1KC104K3	80063	52	47	CR109-97	82679	1	117
CP05A1KC104K3	80063	53	48	CR109-98	82679	14	9
CP05A1KC223K3	81349	95	40	CR109-99	82679	15	9
CP05A1KC474H	81349	100	9	CR109-10R0	82679	73	37
CP5381EB105Y	81349	76	27	CR119-11R0	82679	73	27
CP5381FE504V	81349	84	3	CR119-12R0	82679	73	39
CP5381FF254V	81350	49	1	CR119-13R0	82679	73	26
CP5481EE504V	81349	76	25	CR119-14R0	82679	73	41
CP5481EE504V	81349	76	26	CR119-14R45	82679	74	25
CP5481EE504V	81349	77	6	CR119-15R0	82679	73	42
CP7081EF405K	81349	81	5	CR119-17R0	13075	63	21
				CR119-17R0	82679	73	36
				CR119-19R0	13075	63	32
				CR119-19R0	13075	67	11
				CR119-8R0	82679	73	28
				CR119-9R0	82679	73	25
				CR36U10000KC	81349	57	5
				CR36U10500KC	81349	57	26
				CR36U11000KC	81349	57	22
				CR36U11500KC	81349	57	1
				CR36U12000KC	81349	57	10
				CR36U12500KC	81349	57	6

Section IV. NATIONAL STOCK NUMBER AND PART NUMBER INDEX

PART NUMBER	FSCM	FIG ITEM		PART NUMBER	FSCM	FIG ITEM	
		NO.	NO.			NO.	NO.
CR36U13000KC	81349	57	9	FW04HBN	82679	13	37
CR36U14000KC	81349	57	7	FW04HBN	82679	14	27
CR36U1450000MHZ	81349	57	3	FW04HBN	82679	15	27
CR36U15000KC	81349	57	20	FW04HBN	82679	16	30
CR36U15500KC	81349	57	2	FW04HBN	82679	25	31
CR36U16000KC	81349	57	21	FW04HBN	82679	25	35
CR36U17000KC	81349	57	23	FW04HBN	82679	25	39
CR36U9000KC	81349	57	8	FW04HBN	82679	27	91
CR36U9500KC	81349	57	4	FW04HBN	82679	27	95
CV11A070	81349	77	2	FW04HBN	82679	27	99
CV11A070	81349	83	13	FW04HBN	82679	32	22
CV11C450	81349	76	14				
CV11C450	81349	77	95				
CV11C450	81349	77	101	FW04LBN	82679	17	59
CV3300/TSC-25		75					
DA15P	71468	103	17	FW04LBN	82679	18	35
DA314U	82679	110	A	FW04LBN	82679	19	54
DDA104	71590	99	17	FW04LBN	82679	20	53
DDA104	71590	103	4	FW04LBN	82679	22	23
DDA503	71590	99	7	FW04LBN	82679	22	30
DDA503	71590	101	20	FW04LBN	82679	22	37
DKCR76-1	94375	62	1	FW04LBN	82679	23	59
DS09F	15826	3	43	FW04LBN	82679	24	48
DOT20	89665	95	4	FW04LBN	82679	25	44
DOT25	89665	99	28	FW04LBN	82679	26	30
D0T25	89665	101	3	FW04LBN	82679	27	105
0164914	80063	114	3	FW04LBN	82679	31	11
EB3925	81349	45	11				
EZ248M	99872	41	1	FW06HBN	82679	20	50
E1408	01591	100	29	FW10HBN	82679	20	9
E18D27	00656	77	94	FW10HBN	82679	20	16
				FX267	82679	13	58
				FX268	62679	16	15
FA9481	51432	107	3	FX269	82679	22	28
FA9842	51932	5	1	FX270	82679	22	21
FG1-1200	20625	3	17	FX280	82679	25	14
FG1-1200S	79614	3	42	FX281	82679	25	16
FIC2	82877	34					
FR114U	82679	1	23	FX282	82679	25	12
FR20	24681	91	1	FX287	82679	29	4
FU102-1	82679	65	16	F02GR5008	81349	92	13
FU102-10	82679	29	36	F02GR5008	81349	98	15

Section IV. NATIONAL STOCK NUMBER AND PART NUMBER INDEX

PART NUMBER	FSCM	FIG ITEM		PART NUMBER	FSCM	FIG ITEM	
		NO.	NO.			NO.	NO.
F02GR5008	81349	104	14				
F02GR750A	81349	48	5				
F01GR50A	96906	37	4	JJ033	82389	29	44
FIC2	82877	4	19				
F03GR0108	96906	95	13	JJ034	82389	29	45
F40X	81095	48	9	JJ034	81349	61	39
F409-004	72928	66	14	JJ042	81349	90	3
GA2N040550ZMZ	81349	95	42	JJ171-2	74868	63	19
GA2N040S253UZ	81349	95	39	JJ319-60PE	82679	30	10
GA2N040S253UZ	08313	100	1	JJ319-60PE	82679	33	1
GA2N040S501MZ	08313	99	12	JJ319A15DFE	82679	29	13
GA2N040S502MZ	08313	95	41	JJ319A150PE	82679	21	1
GC1045C	96906	45	5	JS1N200P151UA	08313	48	20
				J55	91929	85	17
GP2	80063	3	39	JT97348	01121	29	37
				KRP11D	02470	37	10
GV27502-6	77554	3	30	KRP5D	77342	92	5
				KRP5D	77342	98	10
				KRPSD	77342	104	9
G130	01295	95	9	KWX11TSEC	82679	1	14
				KWX11TSEC	82679	42	995
G130	01295	99	9	LBAD-D-12345	82679	1	1
				LBAD-D-12346	82679	1	8
G130	01295	100	18	LBAD-D-12347	82679	1	9
				LBAD-D-12348	82679	1	12
G130	01295	101	2	LBAD-D-12349	82679	1	15
				LBAD-D-12350	82679	1	17
G130	82679	103	10	LBAD-D-12351	82679	1	19
				LBAD-D-12352	82679	1	20
G3001A	79725	4	16	LBAD-D-12353	82679	1	21
				LBAD-D-12354	82679	1	4
H-182/PT	82679	1	34				
HD107	82679	20	55	LD2146	82679	12	4
HKLX	71400	37	14	LD2202MS6010	82679	30	12
HKLX	71400	92	18	LD2208MS6007	82679	12	3
H2LX	71400	92	58				
HKLX	71400	98	14	L02209MS6016	82679	29	39
HKP	71400	65	17	L02522MS6398	82679	65	27
				L02523MS6397	82679	65	18
HTA	00628	43	5	LWE02MRN	82679	17	54
				LWE02MRN	82679	19	58
				LWE02MRN	82679	20	58
H166URT	82679	1	5	LWE04MRN	82679	13	36
				LWE04MRN	82679	14	26
IM236-1	82679	13	57	LWE04MRN	82679	15	26
IM236-1	82679	16	66	LWE04MRN	82679	16	29
IM236-2	82679	22	25	LWE04MRN	82679	17	60
IM236-2	82679	22	32	LWE04MRN	82679	18	34
				LWE04MRN	82679	19	55
				LWE04MRN	82679	20	54

Section IV. NATIONAL STOCK NUMBER AND PART NUMBER INDEX

PART NUMBER	FSCM	FIG ITEM		PART NUMBER	FSCM	FIG ITEM	
		NO.	NO.			NO.	NO.
LWE04MRN	82679	22	24	MR135100DCUAR	81349	75	2
LWE04MRN	82679	22	31	MR13S100DCUAR	81349	79	9
LWE04MRN	82679	22	38	MR191-9	82679	29	38
LWE04MRN	82679	23	60	MR2SW5T5DCUA	81349	100	34
LWE04MRN	82679	24	49	MSP051030	13327	17	40
LWE04MRN	82679	25	32	MSP051030	13327	18	28
LWE04MRN	82679	25	36	MSP051030	13327	19	23
				MSP051030	13327	24	6
				MSP051030	13327	26	21
LWE04MRN	82679	26	31	MSP051031	13327	27	27
LWE04MRN	82679	27	92	MSP051031	13327	28	20
LWE04MRN	82679	27	96	MS1184	82679	10	4
LWE04MRN	82679	27	100	MS15571-6	96906	96	3
LWE04MRN	82679	27	106	MS16108-1	96906	95	45
LWE04MRN	82679	31	7	MS16108-1	96906	99	20
LWE04MRN	82679	31	12	MS16108-1	96906	100	30
LWE06MRN	82679	20	51	MS16108-1	96906	101	1
LWE06MRN	82679	66	33	MS16108-1	96906	101	22
LWE06MRN	82679	68	35	MS16108-2	96906	95	43
LWE06MRN	82679	71	5	MS16108-2	96906	99	23
LWE06MRN	82679	72	45	MS16108-3	96906	92	2
LWE10MRN	82679	20	10	MS16108-3	96906	98	2
LWE10MRN	82679	20	17	MS16108-3	96906	99	22
MAPC50	80503	78	7	MS16108-3	96906	104	2
				MS16108-7	96906	95	44
MCP12A2KB222M	81349	77	1	MS16633-1012	96906	58	79
MC4016P	04713	66	4	MS16633-1025	96906	58	81
MDA960-3	01295	65	4	MS16633-18	96906	58	80
MDA970-3	01295	31	2	MS171434	96906	58	129
MDL1-1-2	71400	37	5	MS171466	96906	58	118
ME22APCM	82679	1	6	MS18209-387	24455	4	20
ME22APCH	82679	36	991	MS24055-1	96906	50	17
ME26U	82679	1	24	MS24055-1	96906	61	9
MIL-C-11015-19	81349	45	17				
MILW3861	81349	3	31	MS24056-1	96906	56	2
MIP88-8	02660	49	5	MS24056-1	96906	60	1
				MS25168-P18	81349	42	2
				MS3100E18-11P	81349	77	131
MODEL 1	00628	43	6	MS3102A16S5P	96906	29	87
MODEL 408	17191	45	15	MS3102A16S5P	96906	65	3
MODEL P642TYEP A	11755	40	1	MS3106A16S5C	02660	115	16
MIRAC75P8	59730	4	4	MS3110E14-5P	81349	86	4
MR05W001DCMA	81349	99	19	MS3116F14-5S	81349	77	132
				MS35059	96906	92	16

Section IV. NATIONAL STOCK NUMBER AND PART NUMBER INDEX

PART NUMBER	FSCM	FIG ITEM		PART NUMBER	FSCM	FIG ITEM	
		NO.	NO.			NO.	NO.
MS35059-23	96906	98	19	MS6015	82679	29	24
MS35059-23	81349	104	18	MS6017	82679	20	53A
MS35059-24	96906	37	3	MS6058	82679	11	1
MS35059-24	96906	37	6	MS6055	82679	31	5
MS35059-24	96906	98	18	MS6058	82679	12	1
MS35059-24	81349	104	17	MS6059	82679	12	2
MS35120	96906	85	1	MS6063	82679	31	8
MS35179-1094A	96909	79	20				
MS3S200-25	96906	58	29	MS6063	82679	32	19
MS35200-25	96906	58	92	MS6366	82679	10	10
MS35200-39	96906	58	93	MS6396-1	82679	65	14
MS35216-13	96906	58	95	MS6396-2	82679	65	6
MS35216-23	96906	50	2	MS6399	82679	64	1
MS35216-23	96906	58	96	MS6459	82679	88	6
				MS90078-27-1	96906	50	20
MS35216-25	96906	58	99	MS90287-3	96906	81	11
MS35216-26	96906	58	100	MS90287-4	96906	77	85
MS35216-40	96906	58	101	MS90287-4	96906	79	12
MS35338-21	96906	58	103	MS90287-6	96906	77	86
MS35338-79	96906	50	4	MS90287-6	96906	79	11
MS35338-79	96906	58	102	MS91528-1P2D	96906	46	1
MS35338-80	96906	58	104	MT332C	82389	38	1
MS5011	82679	17	51	MT332C	82389	90	1
				MT332C	82389	91	13
MS5011	82679	19	59	MT332C	82389	97	4
				MX7738	82679	3	54
MS5112	82679	29	19	M21097-1-163	81349	86	'3
				M21097-1-172	81349	79	19
MS5395	82679	27	102	M2555	21937	80	4
				M39012-16-0002	81349	118	7
MS6004	82679	13	38	M39012-25-0003	81349	118	8
MS6004	82679	14	28	M6	27956	16	3
MS6004	82679	15	28	M6	27956	74	9
MS6004	82679	11	56	M7PLRN	81312	85	2
MS6004	82679	18	36	NBCK15-7	02598	84	11
MS6004	82679	19	52	NE2D	85599	65	9
MS6004	82679	22	34	NE45	81349	62	2
MS6004	82679	23	56	NE45	24455	108	5
MS6004	82679	24	45	NE51	24455	37	12
MS6004	82679	25	41	NE51	81349	39	2
				NE51	81349	44	3
MS6004	82679	26	27	NE51	24455	92	14
MS6005	82679	16	31	NE51	60969	98	16
MS60059	82679	11	2	NE51	60969	104	15
MS6009	82679	29	20	NF116-3	82679	30	20

Section IV. NATIONAL STOCK NUMBER AND PART NUMBER INDEX

PART NUMBER	FSCM	FIG ITEM		PART NUMBER	FSCM	FIG ITEM	
		NO.	NO.			NO.	NO.
NF116-3	82679	65	20	NTH0256BN6	82679	20	56
NLW10-25	56289	13	29	NTH0440BN4	82679	25	38
NLW10-25	56289	22	18	NTH0440BN5	82679	17	57
NLW10-25	56289	27	8	NTH0440BN5	82679	24	46
NLW10-25	56289	66	17	NTH0440BN6	82679	13	35
NLW10-25	56289	69	4	NTH0440BN6	82679	14	25
NLW10-25	56289	73	13	NTH0440BN6	82679	15	25
NLW100-25	56289	66	25	NTH0440BN6	82679	16	28
NLW100-25	56289	70	9	NTH0440BN6	82679	18	33
NLW125-15	56289	13	28	NTH0440BN6	82679	19	56
NLW175-15	56289	13	26	NTH0440BN6	82679	22	22
NLW2-25	56289	13	20	NTH0440BN6	82679	22	29
NLW2-25	56289	69	13	NTH0440BN6	82679	22	35
NLW2-50	56289	13	34	NTH0440BN6	82679	23	57
NLW2-50	56289	22	16	NTH0440BN6	82679	25	30
NLW20-50	56289	20	5				
NLW25-25	56289	13	25				
NLW5-25	56289	69	6				
NLW5-25	56289	70	20	NTH0440BN6	82679	26	28
NLW50-15	56289	20	19	NTH0440BN6	82679	27	93
NLW50-15	56289	74	21	NTH0440BN6	82679	27	97
NLW50-50	56289	20	6	NTH0440BN6	82679	27	101
NLW50-50	56289	22	43	NTH0440BN6	82679	27	103
NLW75-15	56289	22	51	NTH0440BN6	82679	31	9
NO NUMBER	81349	83	7	NTH0440BN6	82679	32	20
NRCTYPE222MODEL 4	88183	104	12	NTH0632BN8	82679	20	49
NRCTYPE222MODEL 5	88183	98	13	NTH1032BN10	82679	20	8
NRCTYPE234MODEL 2	88183	99	1	NTH1032BN10	82679	20	15
NRC212-3ZD4	88183	103	21	NT137-0440	82679	27	54
NRC234	74130	92	8	NT137-0632	82679	16	56
NRC234	88183	95	21				
NRC234	88183	98	8	NT137-0832	82679	20	22
NRC234	88183	104	7	NT137-1032	82679	20	23
NRC641	88183	95	22	NT137-1032	82679	70	29
NRC692	06778	102	1	NT137-1032	82679	70	32
NRC697	88183	103	20	NT137-2520	82679	66	11
NRC886	88183	103	18	OA2W	81349	51	10
NRC904	88183	103	19	OSC86-1	82679	86	1
NTH0256BN6	82679	17	52	OSC86-2	82679	86	2
				OS8U	82679	1	26
NTH0256BN6	82679	19	57	PA1001	07886	100	35

Section IV. NATIONAL STOCK NUMBER AND PART NUMBER INDEX

PART NUMBER	FSCM	FIG ITEM		PART NUMBER	FSCM	FIG ITEM	
		NO.	NO.			NO.	NO.
PC135	84411	63	10				
PC300	82679	17	50				
PC301	82679	24	50	PL218	82679	115	17
PC302	82679	18	38	PX370-8-7	82679	27	80
PC304	82679	14	30	PX829-1	82679	16	40
PC304	82679	15	30	PX829-3	82679	32	23
PC305	82679	21	2	P13-485010	11190	48	12
PC306	82679	20	59	P18014	11190	48	15
PC322	82679	25	40	P18015	11190	48	13
PC323	82679	27	108	P18016	11190	48	7
PC324	82697	26	26	P2A	64959	4	15
PC329	82679	31	4	P2A	64959	114	2
PC330	82679	32	17				
PC336	82679	19	50	P2AA	64959	4	14
PC337	82679	22	33	P202B	07233	37	9
PC338	82679	16	33	P202B	07233	98	4
PC339	82679	13	40	P202B	07233	104	19
PC355	82679	33	2	P2553	21937	81	15
PC337	82679	28	31	P302N12UF150V	00656	76	28
PC383	82679	23	61	P306A8	07233	48	8
PC646	82679	74	22	QP120	14280	108	2
PC650	82679	68	32	QQ345	81349	3	36
				Q0-115	14280	108	1
PC651	82679	71	2	Q0-130	14280	108	4
				Q0-320	14280	108	3
PC652	82679	72	42	Q0-350	14280	108	7
				Q1370	14280	108	8
PC653	82679	66	29	RACK	82679	36	997
				RACK	82679	42	991
PC654	82679	69	2	RACK	82679	45	991
				RACK	81679	47	996
PC657	82679	70	28	RACK	82679	75	1029
				RACK402	82679	4	
PC658	82679	67	21	RACK403A1	82679	35	991
				RAC30	82679	2	2
PC673	82679	65	37	RCR076101JS	81349	77	192
				RCR07G102JS	81349	51	22
PC674	82679	63	30	RCR07G102JS	81349	77	146
				RCR07G103JS	81349	77	170
				RCR07G183JS	81349	77	195
				RCR07G184JS	81349	77	194
				RCR07G22ZJS	81349	51	25
				RCR07G223JS	81349	51	18
				RCR07G332JS	81349	53	9
PJ1	70674	91	14	RCR07G680JS	81349	53	2
				RCR07G680JS	81349	77	189
PJ22	70674	91	10	RCR07G681JS	81349	77	183
				RCR07G821JS	81349	53	45
PJ318	70674	91	15	RCR20G101JS	81349	53	46
				RCR20G152JS	81349	51	16
PJ339	70674	47	1	RCR32G180JS	81349	77	186
				RC07GF100J	81349	18	46
PJS2	70674	91	11	RC07GF100J	81349	24	43
				RC07GF100J	81349	25	17

Section IV. NATIONAL STOCK NUMBER AND PART NUMBER INDEX

PART NUMBER	FSCM	FIG ITEM		PART NUMBER	FSCM	FIG ITEM	
		NO.	NO.			NO.	NO.
RC07GF100J	81349	26	77	RC07GF102J	81349	32	3
RC07GF100J	81349	28	8	RC07GF102J	81349	66	1
RC07GF100J	81349	66	23	RC07GF102J	81349	67	1
				RC07GF102J	81349	67	23
RC07GF100J	81349	69	35	RC07GF102J	81349	69	23
RC07GF100J	81349	70	23	RC07GF102J	81349	70	21
RC07GF100J	81349	73	S2	RC07GF102J	81349	72	7
RC07GF101J	81349	13	18	RC07GF102J	81349	73	23
RC07GF101J	81349	14	2	RC07GF102J	81349	74	11
RC07GF101J	81349	15	2	RC07GF102J	81349	95	19
RC07GF101J	81349	16	9	RC07GF102J	81349	99	26
RC07GF101J	81349	22	27	RC07GF102J	81349	100	23
RC07GF101J	81349	23	33	RC07GF102J	81349	101	7
RC07GF101J	81349	24	31	RC07GF102J	81349	103	8
RC07GF101J	81349	26	48	RC07GF103J	81349	13	11
RC07GF101J	81349	27	26	RC07GF103J	81349	16	21
RC07GF101J	81349	29	48	RC07GF103J	81349	17	33
RC07GF101J	81349	29	50	RC07GF103J	81349	18	15
RC07GF101J	81349	68	6	RC07GF103J	81349	19	36
RC07GF101J	81349	72	27	RC07GF103J	81349	22	4
RC07GF101J	81349	73	24	RC07GF103J	81349	23	24
RC07GF101J	81349	99	2	RC07GF103J	81349	25	19
RC07GF102J	81349	13	5	RC07GF103J	81349	26	62
RC07GF102J	81349	14	1s	RC07GF103J	81349	27	33
RC07GF102J	81349	1s	15	RC07GF103J	81349	32	14
RC07GF102J	81349	16	13	RC07GF103J	81349	63	38
RC07GF102J	81349	1?	is	RC07GF103J	81349	67	13
RC07GF102J	81349	18	13	RC07CF103J	81349	69	25
RC07GF102J	81349	19	26	RC07GF103J	81349	72	6
RC07GF102J	81349	22	1	RC07GF103J	81349	73	46
RC07GF102J	81349	23	23	RC07GF103J	81349	74	2
RC07GF102J	81349	24	24	RC07GF103J	81349	95	1
RC07GF102J	81349	25	9	RC07GF103J	81349	99	5
RC07GF102J	81349	26	34	RC07GF103J	81349	100	19
RC07GF102J	81349	27	29	RC07GF103J	81349	101	16
RC07GF102J	81349	28	9	RC07GF103J	81349	103	13
RC07GF102J	81349	29	65	RC07GF104J	81349	16	41
RC07GF102J	81349	29	85	RC07GF104J	81349	17	26
RC07GF102J	81349	29	94	RC07GF104J	81349	19	37
				RC07GF104J	81349	22	49

Section IV. NATIONAL STOCK NUMBER AND PART NUMBER INDEX

PART NUMBER	FSCM	FIG ITEM		PART NUMBER	FSCM	FIG ITEM	
		NO.	NO.			NO.	NO.
RC07GF104J	8139	23	48	RC07GF152J	81349	13	2
RC07GF104J	81349	27	22	RC07GF152J	81349	16	52
RC07GF104J	81349	28	15	R07GFF152J	81349	17	22
RC07GF104J	81349	63	9	RC07GF152J	81349	18	63
RC07GF104J	81349	68	21	RC07GF152J	81349	19	49
RC07GF104J	81349	73	51	RC07GF152J	81349	22	15
RC07GF105J	81349	18	52	RC07GF152J	81349	26	71
RC07GF105J	81349	68	29	RC07GF152J	81349	32	13
				RC07GF152J	81349	77	193
RC07GF105J	81349	95	27	RC07GF152J	81349	99	25
RC07GF106J	81349	26	36	RC07GF152J	81349	100	28
RC07GF120J	81349	13	50	RC07GF153J	81349	14	18
RC07GF121J	81349	17	23	RC07GF153J	81349	15	18
RC07GF121J	81349	18	10	RC07GF153J	81349	16	10
RC07GF121J	81349	19	4	RC07GF153J	81349	22	19
RC07GF12LJ	81349	24	19	RC07GF153J	81349	23	36
RC07GF121J	81349	26	57	RC07GF153J	81349	26	79
RC07GF121J	81349	27	31	RC07GF153J	81349	66	21
RC07GF121J	81349	28	2	RC07GF153J	81349	69	32
RC07GF122J	81349	13	24	RC07GF153J	81349	95	6
RC07GF122J	81349	18	39	RC07GF153J	81349	100	11
RC07GF122J	81349	22	26	RC07GF153J	81349	101	18
RC07GF122J	81349	26	55	RC07GF154J	81349	92	9
RC07GF122J	81349	66	28	RC07GF154J	81349	100	26
RC07GF122J	81349	68	26	RC07GF180J	81349	17	32
RC07GF122J	81349	72	12	RC07GF180J	81349	19	33
RC07GF122J	81349	73	35	RC07GF180J	81349	26	37
RC07GF123J	81349	13	47	RC07GF181J	81349	18	31
RC07GF123J	81349	18	42	RC07GF181J	81349	23	22
RC07GF123J	81349	24	34	RC07GF181J	81349	24	28
RC07GF124J	81349	63	12	RC07GF181J	81349	26	52
RC07GF150J	81349	17	6	RC07GF181J	81349	28	1
RC07GF150J	81349	18	20	RC07GF181J	81349	74	23
RC07GF150J	81349	19	11	RC07GF182J	81349	13	48
RC07GF150J	81349	24	26	RC07GF182J	81349	16	14
RC07GF150J	81349	26	53	RC07GF182J	81349	18	8
RC07GF151J	81349	25	20	RC07GF182J	81349	24	23
RC07GF151J	81349	27	48	RC07GF182J	81349	63	37
RC07GF151J	81349	32	10	RC07GF182J	81349	67	12
RC07GF151J	81349	100	13	RC07GF182J	81349	69	30

Section IV. NATIONAL STOCK NUMBER AND PART NUMBER INDEX

PART NUMBER	FSCM	FIG ITEM		PART NUMBER	FSCM	FIG ITEM	
		NO.	NO.			NO.	NO.
RC07GF182J	81349	72	1	RC07GF222J	81349	95	28
RC07GF182J	81349	73	47	RC07GF222J	81349	101	11
RC07GF182J	81349	74	15	RC07GF223J	81349	13	30
RC07GF183J	81349	17	19	RC07GF223J	81349	16	48
RC07GF220J	81349	18	48	RC07GF223J	81349	18	60
RC07GF220J	81349	24	22	RC07GF223J	81349	22	44
RC07GF220J	81349	26	58	RC07GF223J	81349	27	42
RC07GF220J	81349	27	38	RC07GF223J	81349	68	2
RC07GF220J	81349	66	9	RC07GF223J	81349	101	19
RC07GF220J	81349	73	32	RC07GF224J	81349	27	30
RC07GF221J	81349	16	44	RC07GF242J	81349	18	66
RC07GF221J	81349	17	25	RC07GF270J	81349	23	43
RC07GF221J	81349	18	3	RC07GF270J	81349	24	33
RC07GF221J	81349	19	34	RC07GF270J	81349	26	61
RC07GF221J	81349	22	52	RC07GF271J	81349	13	45
RC07GF221J	81349	26	38	RC07GF271J	81349	17	18
RC07GF221J	81349	27	57	RC07GF271J	81349	18	40
				RC07GF221J	81349	18	58
RC07GF221J	81349	29	67	RC07GF271J	81349	19	30
RC07GF221J	81349	63	25	RC07GF271J	81349	23	30
RC07GF221J	81349	72	11	RC07GF271J	81349	26	40
RC07GF221J	81349	73	43	RC07GF271J	81349	63	22
RC07GF221J	81349	95	18	RC07GF271J	81349	67	4
RC07GF221J	81349	99	14	RC07GF271J	81349	72	3
RC07GF221J	81349	100	2	RC07GF271J	81349	73	31
RC07GF221J	81349	101	5	RC07GF271J	81349	74	13
RC07GF222J	81349	16	53	RC07GF272J	81349	23	44
RC07GF222J	81349	17	29	RC07GF272J	81349	68	7
RC07GF222J	81349	18	67	RC07GF272J	81349	69	21
RC07GF222J	81349	19	35	RC07GF272J	81349	72	8
RC07GF222J	81349	23	50	RC07GF273J	81349	13	6
RC07GF222J	81349	26	42	RC07GF273J	81349	17	3
RC07GF222J	81349	29	86	RC07GF273J	81349	19	7
RC07GF222J	81349	29	96	RC07GF273J	81349	22	5
RC07GF222J	81349	66	18	RC07GF273J	81349	27	39
RC07GF222J	81349	69	31	RC07GF274J	81349	70	S
RC07GF222J	81349	70	16	RC07GF275 J	81349	63	14
RC07GF222J	81349	72	38	RC07GF304J	81349	29	25
RC07GF222J	81349	73	44	RC07GF330J	81349	16	65
RC07GF222J	81349	95	24	RC07GF330J	81349	18	51

Section IV. NATIONAL STOCK NUMBER AND PART NUMBER INDEX

PART NUMBER	FSCM	FIG ITEM		PART NUMBER	FSCM	FIG ITEM	
		NO.	NO.			NO.	NO.
RC07GF330J	81349	27	24	RC07GF333J	81349	69	40
RC07GF330J	81349	28	11	RC07GF333J	81349	100	24
RC07GF330J	81349	73	29	RC07GF333J	81349	101	14
RC07GF331J	81349	13	52	RC07GF334J	81349	27	32
RC07GF331J	81349	16	25	RC07GF390J	81349	13	43
RC07GF331J	81349	17	7	RC07GF390J	81349	27	70
RC07GF331J	81349	18	19	RC07GF391J	81349	17	9
RC07GF331J	81349	19	14	RC07GF391J	81349	18	22
RC07GF331J	81349	23	62	RC07GF391J	81349	19	16
RC07GF331J	81349	24	18	RC07GF391J	81349	23	42
RC07GF331J	81349	25	8	RC07GF392J	81349	17	31
RC07GF331J	81349	26	54	RC07GF392J	81349	19	38
RC07GF331J	81349	27	75	RC07GF392J	81349	23	51
RC07GF331J	81349	28	30	RC07GF392J	81349	25	24
RC07GF331J	81349	66	16	RC07GF392J	81349	67	22
RC07GF331J	81349	69	36	RC07GF392J	81349	70	13
RC07GF331J	81349	72	19	RC07GF392J	81349	73	22
RC07GF331J	81349	74	6	RC07GF392J	81349	74	12
RC07GF331J	813/9	95	26	RC07GF393J	81349	25	23
RC07GF331J	81349	101	4	RC07GF393J	81349	70	7
RC07GF332J	81349	13	31	RC07GF4R7J	81349	72	28
RC07GF332J	81349	14	36	RC07GF470J	81349	13	44
RC07GF332J	81349	15	35	RC07GF470J	81349	17	24
RC07GF332J	81349	16	63	RC07GF470J	81349	18	26
RC07GF332J	81349	17	8	RC07GF470J	81349	19	18
RC07GF332J	81349	18	44	RC07GF470J	81349	23	27
RC07GF332J	81349	19	13	RC07GF470J	81349	24	37
RC07GF332J	81349	23	35	RC07GF470J	81349	26	45
RC07GF332J	81349	26	78	RC07GF470J	81349	27	23
RC07GF332J	81349	27	50	RC07GF470J	81349	28	12
RC07GF332J	81349	70	27	RC07GF470J	81349	29	15
RC07GF332J	81349	100	12	RC07GF470J	81349	63	34
RC07GF332J	81349	101	13	RC07GF470J	81349	66	15
RC07GF332J	81349	103	7	RC07GF470J	81349	67	6
RC07GF333J	81349	13	12	RC07GF470J	81349	68	1
RC07GF333J	81349	16	64	RC07GF470J	81349	69	20
RC07GF333J	81349	22	12	RC07GF470J	81349	70	12
RC07GF333J	81349	23	26	RC07GF470J	81349	72	2
RC07GF333J	81349	68	4	RC07GF470J	81349	73	33

Section IV. NATIONAL STOCK NUMBER AND PART NUMBER INDEX

PART NUMBER	FSCM	FIG ITEM		PART NUMBER	FSCM	FIG ITEM	
		NO.	NO.			NO.	NO.
RC07GF470J	81349	74	7	RC07GF473J	81349	27	21
RC07GF471J	81349	13	9	RC07GF473J	1349	28	13
RC07GF471J	81349	16	11	RC07GF473J	81349	29	89
RC07GF471J	81349	17	5	RC07GF473J	81349	29	92
RC07GF471J	81349	18	7	RC07GF474J	81349	14	1
RC07GF471J	81349	19	15	RC07GF474J	81349	15	1
RC07GF471J	81349	22	9	RC07GF474J	81349	22	47
RC07GF471J	81349	27	40	RC07GF474J	81349	23	32
RC07GF471J	81349	29	49	RC07GF474J	81349	68	12
RC07GF471J	81349	29	51	RC07GF474J	81349	87	6
RC07GF471J	81349	29	81	RC07GF560J	81349	17	34
RC07GF471J	81349	32	11	RC07GF560J	81349	18	65
RC07GF471J	81349	66	24	RC07GF560J	81349	19	47
RC07GF471J	81349	67	5	RC07GF560J	81349	26	32
RC07GF471J	81349	68	25	RC07GF561J	81349	13	42
RC07GF471J	81349	69	29	RC07GF561J	81349	14	3
RC07GF471J	81349	70	14	RC07GF561J	81349	15	3
RC07GF471J	81349	73	45	RC07GF561J	81349	16	7
RC07GF471J	81349	74	16	RC07GF561J	81349	17	14
RC07GF471J	81349	95	7	RC07GF561J	81349	18	45
RC07GF471J	81349	100	5	RC07GF561J	81349	19	29
RC07GF472J	81349	13	33	RC07GF561J	81349	23	38
RC07GF472J	81349	16	45	RC07GF561J	81349	27	68
RC07GF472J	81349	17	11	RC07GF561J	81349	67	8
RC07GF472J	81349	18	18	RC07GF561J	81349	68	27
RC07GF472J	81349	19	32	RC07GF561J	1349	73	49
RC07GF472J	81349	23	45	RC07GF562J	81349	25	22
RC07GF472J	81349	27	36	RC07GF562J	81349	27	89
RC07GF472J	81349	32	5	RC07GF562J	81349	67	19
RC07GF472J	81349	68	31	RC07GF562J	81349	69	19
RC07GF472J	81349	69	38	RC07GF562J	81349	70	3
RC07GF472J	81349	77	190				
RC07GF472J	81349	95	10	RC07GF563J	81349	22	46
RC07GF472J	81349	99	21	RC07GF563J	81349	27	45
RC07GF472J	81349	100	25	RC07GF563J	81349	29	22A
RC07GF472J	81349	101	15	RC07GF563J	81349	10	18
RC07GF473J	81349	16	18	RC07GF621J	81349	103	11
RC07GF473J	81349	18	55	RC07GF622J	81349	29	97
RC07GF473J	81349	22	17	RC07GF680J	81349	24	38
RC07GF473J	81349	26	60	RC07GF680J	81349	25	2

Section IV. NATIONAL STOCK NUMBER AND PART NUMBER INDEX

PART NUMBER	FSCM	FIG ITEM		PART NUMBER	FSCM	FIG ITEM	
		NO.	NO.			NO.	NO.
RC07GF680J	81349	26	43	RC07GF822J	81349	27	51
RC07GF680J	81349	29	12	RC07GF822J	81349	28	10
RC07GF680J	81349	99	10	RC07GF824J	81349	27	34
RC07GF681J	81349	17	20				
RC07GF681J	81349	18	30	RC20F154J	81349	77	44
RC07GF681J	81349	19	21	RC20GF100J	81349	20	35
RC07GF681J	81349	68	23	RC20GF101J	81349	17	30
RC07GF681J	81349	73	1	RC20GF101J	81349	19	41
RC07GF681J	81349	95	23	RC20GF101J	81349	20	11
RC07GF682J	81349	13	32	RC20GF101J	81349	77	175
RC07GF682J	81349	16	22	RC20GF101K	81349	52	58
RC07GF682J	81349	17	17	RC20GF102J	81349	20	33
RC07GF682J	81349	18	23	RC20GF102J	81349	78	4
RC07GF682J	81349	19	27	RC20GF102J	81349	102	5
RC07GF682J	81349	27	76	RC20GF102K	81349	51	33
RC07GF682J	81349	32	16	RC20GF102K	81349	52	12
RC07GF682J	81349	100	10	RC20GF102K	81349	53	12
RC07GF683J	81349	27	46	RC20GF103J	81349	26	75
RC07GF683J	81349	69	27	RC20GF103J	81349	56	49
RC07GF683J	81349	95	5	RC20GF103J	81349	77	78
RC07GF8R2J	81349	18	11	RC20GF103J	81349	77	90
RC07GF8R2J	81349	27	49	RC20GF103J	81349	77	145
RC07GF820J	81349	27	69	RC20GF103J	81349	77	167
RC07GF820J	81349	29	11	RC20GF103J	81349	77	214
RC07GF820J	81349	74	26	RC20GF103J	81349	79	1
RC07GF821J	81349	24	16	RC20GF104J	81349	65	8
RC07GF821J	81349	27	44	RC20GF104J	81349	77	120
RC07GF821J	81349	70	6	RC20GF104J	81349	77	157
RC07GF821J	81349	73	50	RC20GF104J	81349	77	161
RC07GF822J	81349	13	1	RC20GF104J	81349	77	200
RC07GF822J	81349	14	4	RC20GF104K	81349	52	9
RC07GF822J	81349	15	4	RC20GF104K	81349	53	7
RC07GF822J	81349	17	21	RC20GF104K	81349	56	78
RC07GF822J	81349	18	64	RC20GF105J	81349	52	52
RC07GF822J	81349	19	48	RC20GF105J	81349	53	1
RC07GF822J	81349	23	21	RC20GF105J	81349	77	18
RC07GF822J	81349	24	17	RC20GF105J	81349	77	23
RC07GF822J	81349	25	7	RC20GF105J	81349	77	52
RC07GF822J	81349	26	33	RC20GF105J	81349	82	14

Section IV. NATIONAL STOCK NUMBER AND PART NUMBER INDEX

PART NUMBER	FSCM	FIG ITEM		PART NUMBER	FSCM	FIG ITEM	
		NO.	NO.			NO.	NO.
RC20GF105K	81349	56	42	RC20GF183J	81349	77	137
RC20GF121J	81349	77	59	RC20GF184J	81349	52	8
RC20GF122J	81349	51	23	RC20GF184J	81349	53	8
RC20GF122J	81349	77	16	RC20GF184J	81349	77	71
RC20GFP22J	81349	77	30	RC20GF220J	81349	20	38
RC20GF122J	81349	77	81	RC20GF220K	81349	101	8
RC20GF122J	81349	77	88	RC20GF221J	81349	20	32
RC20GF122J	81349	79	5	RC20GF221J	81349	56	52
RC20GF123J	81349	77	20	RC20GF222J	81349	20	18
RC20GF123J	81349	79	6	RC20GF222J	81349	48	18
RC20CF124J	81349	77	24	RC20GF222J	81349	S2	34
RC20GF124J	81349	77	70	RC20GF222J	81349	53	37
RC20GF124J	81349	77	212	RC20GF222J	81349	56	45
RC20GF124K	81349	56	62	RC20GF222J	81349	65	36
RC20GF124K	81349	57	43	RC20GF222J	81349	77	32
RC20GF125J	81349	77	68	RC20GF222J	81349	78	10
RC20GF151	81349	95	11	RC20GF222J	81349	102	6
RC20GF151J	81349	77	3	RC20GF223J	81349	77	134
RC20GF151J	81349	77	151	RC20GF223K	81349	52	30
RC20GF152J	81349	29	103	RC20GF223K	81349	53	27
RC20GF152J	81349	77	31	RC20GF223K	81349	56	41
RC20GF152J	8134w	77	199	RC20GF224J	81349	52	65
RC20GF152J	81349	77	221	RC20GF224J	81349	62	3
RC20GF153J	81349	77	15	RC20GF224J	81349	77	69
RC20GF153J	81349	77	40	RC20GF224J	81349	77	96
RC20GF153J	81349	77	51	RC20GF224J	81349	77	149
RC20GF154J	81349	60	5	RC20GF224J	81349	77	172
RC20GF154J	81349	77	39	RC20GF224J	81349	77	188
RC20GF154J	81349	77	S4	RC20GF224J	81349	77	209
RC20GF154J	81349	77	198	RC20GF224J	81349	78	3
RC20GF154J	81349	98	12	RC20GF224J	81349	80	17
RC20GF154J	81349	104	8	RC20GF226J	81349	27	59
RC20GF155K	81349	96	54	RC20GF226J	81349	27	63
RC20GF181J	81349	13	10	RC20GF226J	81349	28	4
RC20GF181J	81349	77	139	RC20GF226J	81349	28	5
RC20GF182J	81349	77	s8	RC20GF226J	81349	28	17
RC20GF182J	81349	77	100	RC20GF226J	81349	28	19
RC20GF182J	81349	77	106	RC20GF270J	81349	52	14
RC20GF183J	81349	27	72	RC20GF270J	81349	52	62

Section IV. NATIONAL STOCK NUMBER AND PART NUMBER INDEX

PART NUMBER	FSCM	FIG ITEM		PART NUMBER	FSCM	FIG ITEM	
		NO.	NO.			NO.	NO.
RC20GF270J	81349	53	16	RC20GF334K	81349	56	85
RC20GF270J	81349	56	44	RC20GF362J	81349	79	7
RC20GF271J	81349	48	17	RC20GF391J	81349	52	11
RC20GF271K	81349	52	51	RC20GF391J	81349	53	11
RC20GF271K	81349	53	51	RC20GF391J	81349	80	IS
RC20GF273J	81349	29	102	RC20GF391J	81349	80	21
RC20GF273J	81349	77	65	RC20GF392K	81349	57	44
RC20GF273J	81349	80	12	RC20GF394J	81349	52	49
RC20GF273K	81349	52	45	RC20GF394J	81349	52	50
RC20GF273K	81349	52	46	RC20GF394J	81349	53	50
RC20GF273K	81349	52	59	RC20GF394J	81349	53	52
RC20GF274J	81349	77	79	RC20GF394J	81349	77	19
RC20GF274J	81349	77	89	RC20GF433J	81349	20	34
RC20GF274K	81349	56	55	RC20GF433J	81349	80	11
RC20GF275J	81349	51	27	RC20GF470J	81349	20	39
RC20GF275J	81349	52	61	RC20GF470J	81349	30	6
RC20GF330K	81349	56	79	RC20GF470K	81349	51	42
RC20GF331J	81349	77	98	RC20GF471J	81349	26	70
RC20GF331J	81349	77	104	RC20GF471J	81349	77	38
RC20GF331J	81349	79	4	RC20GF471J	81349	77	50
RC20GF332J	81349	20	47	RC20GF471J	81349	80	14
RC20GF332J	81349	77	33	RC20GF471J	81349	80	20
RC20GF332J	81349	77	43	RC20GF471J	81349	102	9
RC20GF332J	81349	77	162	RC20GF472J	81349	77	35
RC20GF332J	81349	77	220	RC20GF472J	81349	77	141
RC20GF332J	81349	97	1	RC20GF472J	81349	77	148
RC20GF333J	81349	25	5	RC20GF472J	81349	77	156
RC20GF333J	81349	77	34	RC20GF472J	81349	77	197
RC20GF333J	81349	77	57	RC20GF472J	81349	77	208
				RC20GF472J	81349	102	11
RC20GF333J	81349	77	153	RC20GF473J	81349	20	28
RC20GF333J	81349	77	171	RC20GF473J	81349	77	113
RC20GF333K	81349	52	27	RC20GF473J	81349	77	117
RC20GF333K	81349	52	54	RC20GF473J	81349	77	142
RC20GF333K	81349	53	24	RC20GF473J	81349	77	215
RC20GF333K	81349	57	41	RC20GF474J	81349	77	17
RC20GF334J	81349	77	25	RC20GF474J	81349	77	49
RC20GF334J	81349	77	53	RC20GF474J	81349	77	77
RC20GF334J	81349	77	185	RC20GF474J	81349	77	187
RC20GF334J	81349	107	6	RC20GF474J	81349	78	2

Section IV. NATIONAL STOCK NUMBER AND PART NUMBER INDEX

PART NUMBER	FSCM	FIG ITEM		PART NUMBER	FSCM	FIG ITEM	
		NO.	NO.			NO.	NO.
RC20GF474K	81349	51	20	RC20GF821J	81349	26	47
RC20GF474K	81349	51	32	RC20GF821K	81349	50	15
RC20GF474K	81349	52	44	RC20GF821K	81349	61	12
RC20GF474K	81349	53	49	RC20GF822J	81349	29	105
RC20GF474K	81349	56	53	RC20GF822K	81349	56	75
RC20GF475J	81349	77	42	RC20GF823J	81349	77	48
RC20GF510J	81349	77	128	RC20GF823J	81349	77	144
RC20GF560J	81349	51	45	RC20GF823J	81349	77	152
RC20GF561J	81349	77	196	RC20GF823J	81349	77	173
RC20GF561J	81349	80	3	RC20GF823J	81349	77	191
RC20GF561J	81349	80	27	RC20GF823J	81349	77	211
RC20GF561K	81349	52	26	RC20GF823J	81349	78	9
RC20GF561K	81349	52	29	RC20GF823K	81349	52	57
RC20GF561K	81349	53	23	RC20GF823K	81349	56	48
RC20GF561K	81349	53	30	RC20GF824K	81349	52	3
RC20GF562K	81349	61	20				
RC20GF562J	81349	20	48	RC30GF124J	81349	80	22
RC20GF562J	81349	29	104	RC30GF393J	81349	77	114
RC20GF562J	81349	77	82	RC30GF393J	81349	80	23
RC20GF562J	81349	77	91	RC32GF100K	81349	100	17
RC20GF563J	81349	29	101	RC32GF102J	81349	20	13
RC20GF563J	81349	56	73	RC32GF102J	81349	63	28
RC20GF563J	81349	60	8	RC32GF102J	81349	77	28
RC20GF563J	81349	61	21	RC32GF120J	81349	91	9
RC20GF680J	81349	77	56	RC32GF121J	81349	91	7
RC20GF680J	81349	77	112	RC32GF151K	81349	101	17
RC20GF680J	81349	77	222	RC32GF154J	81349	51	40
RC20GF680J	81349	82	13	RC32GF181J	81349	23	53
RC20GF681J	81349	51	41	RC32GF184J	81349	51	38
RC20GF681J	81349	77	76	RC32GF2R7K	81349	61	25
RC20GF681J	81349	77	92	RC32GF220J	81349	54	19
RC20GF681K	81349	52	64	RC32GF220J	81349	55	23
RC20GF682K	81349	50	14	RC32GF222J	81349	51	36
RC20GF682K	81349	61	13	RC32GF222J	81349	60	9
RC20GF683J	81349	77	99	RC32GF222J	81349	77	169
RC20GF683J	81349	77	105	RC32GF222K	81349	52	63
RC20GF683J	81349	77	210	RC32GF224J	81349	51	44
RC20GF683J	81349	80	18	RC32GF226J	81349	23	ISA
RC20GF684K	81349	51	24	RC32GF226J	81349	23	47
RC20GF684K	81349	51	29	RC32GF273J	81349	52	22

Section IV. NATIONAL STOCK NUMBER AND PART NUMBER INDEX

PART NUMBER	FSCM	FIG ITEM		PART NUMBER	FSCM	FIG ITEM	
		NO.	NO.			NO.	NO.
RC32GF273J	81349	53	33	RG11AU	96906	3	2
RC32GF301J	81349	91	3	RG11AU	96906	3	2L
RC32GF332J	81349	91	12	RG11AU	96906	36	2
RC32GF390J	81349	70	26	RG174U	80058	18	57
RC32GF391J	81349	77	26	RG174U	80058	19	45
RC32GF393K	81349	56	83	RG187U	81349	60	2
RC32GF431J	81349	91	4	RG188U	80058	16	0
RC32GF471J	81349	91	5	RG188U	80058	17	5
RC32GF511J	81349	91	6	RG188U	80058	23	49
RC32GF561J	81349	91	8	RG188U	80058	24	13
RC32GF561K	81349	51	43	RG188U	80058	25	28
RC32GF562J	81349	105	2	RG188U	80058	26	24
RC32GF562K	81349	56	80	RG188U	80058	27	107
RC32GF563K	81349	51	35	RG58CU	96906	BULK	
RC32GF6R8J	81349	48	14	RG58CU	96906	75	5
RC32GF621J	81349	91	2	RG58CU	96906	115	9
RC32GF682J	81349	96	9	RG58U	80058	10	7
RC32GF821J	81349	48	19	RG62AU	96906	BULK	
RC32GF823J	81349	52	66	RG8U	96906	BULK	
RC42GF101K	81349	95	15				
RC42GF104J	81349	82	11	RG86U	82679	3	11
RC42GF151J	81349	29	99	RH101M	08313	101	10
RC42GF221J	81349	107	4				
RC42GF222J	81349	71	9				
RC42GF223J	81349	52	35				
RC42GF223J	81349	53	35				
RC42GF271J	81349	71	8				
RC42GF332J	81349	77	206				
RC42GF471J	81349	107	5				
RC42GF560J	81349	82	15				
RC42GF562J	81349	77	138				
RC42GF682J	81349	77	27				
RC42GF822J	81349	77	136				
RC42GF823J	81349	77	174				
RC426F124J	81349	82	16				
RC43GF333J	81349	82	10				
RC435U	80058	3	38				

Section IV. NATIONAL STOCK NUMBER AND PART NUMBER INDEX

PART NUMBER	FSCM	FIG ITEM		PART NUMBER	FSCM	FIG ITEM	
		NO.	NO.			NO.	NO.
RH103M	01121	103	14	RV4LAYSAS03A	81349	76	6
RH501M	01121	95	12	RV4LAYS503A	81349	77	12
RH501M	01121	103	9	RV4LAYS503A	81349	80	24
RH503M	01121	103	15	RV4LAYS503A	81349	81	12
RRN60B1472F	81349	99	18	RV4LAYS504A	81349	77	7
RN60B3160F	81349	99	13	RV4LAYS504A	81349	83	2
RN60B3161F	81349	95	8	RV4NAYFD103C	81349	77	5
RN60B3830F	81349	100	6	RV4NAYFD503A	81349	77	72
RN60B4640F	81349	99	4	RV4NAYS01A	82679	29	43
RN60B5111F	81349	99	15	RW107-1	82679	71	7
RN60B7500F	81349	100	4	RW30V3R9	81349	52	18
RN60B7501F	81349	103	5	RW30V3R9	81349	53	19
RN60C51R1F	81349	99	16				
RN60G2492F	81349	103	2	RW30V821	81349	51	15
RN65D2000F	81349	61	27	RW31V202	81349	96	7
RN65D2741F	81349	61	30	RW34G502	81349	81	8
RN65D3571F	81349	61	26	R268RW31V162	81349	51	46
RN65D3921F	81349	61	29	R26CRW31V122	81349	51	47
				R52-2500 ±1%	81349	45	14
				SA143	07999	63	5
RP101FD2J2KK	96906	42	1	SA9507	07886	77	124
RP101FK252KK	96906	46	2	SA9507	07886	79	17
RR117-140	82679	110	1	SA9507	07886	85	7
RVNAYS0102A	81349	83	7				
RV106UX8B102A	82679	29	88	SB-1577/FRT	82679	1	3
				SBD22MO	81349	77	129
RV106UX8B103A	82679	29	46	SCA2B	76149	100	31
RV106UX8B103A	82679	29	107	SCBP0256BN4	82679	17	53
RV108-2	82679	29	28	SCBP0256BN4	82679	19	51
RV2LAXSA101B	81349	54	18	SCBP0256BN6	82679	20	57
RV2LAXSA101B	81349	55	22	SCBP0440BN4	82679	16	32
				SCBP0440BN5	82679	25	42
RV2LAXSA103B	81349	54	20	SCBP0440BN5	82679	13	39
RV2LAXSA103B	813349	55	24	SCBP0440BN5	82679	14	29
RV3LAXSA503A	81349	77	84				
RV4LAXSA252A	81349	76	23	SCBP0440BN5	82679	15	29
RV4LAXSA252A	81349	77	123	SCBP0440BN5	82679	17	58
RV4LAXSA254A	81349	76	39	SCBP0440BN5	82679	18	37
RV4LAXSA254A	81349	77	181	SCBP0440BN5	82679	19	53
RV4LAYS102A	81349	77	13	SCBP0440BN5	82679	20	52
RV4LAYS102A	81349	83	6	SCBP0440BN5	82679	22	36
RV4LAYS103A	81349	77	10	SCBP0440BN5	82679	23	58
RV4LAYS103A	81349	83	4	SCBP0440BN5	82679	24	47
				SCEP0440BN5	82679	25	34
RV4LAYS252A	81349	77	4	SCBP0440BN5	82679	25	43
RV4LAYS252A	81349	83	1	SCBP0440BN5	82679	26	29

Section IV. NATIONAL STOCK NUMBER AND PART NUMBER INDEX

PART NUMBER	FSCM	FIG ITEM		PART NUMBER	FSCM	FIG ITEM	
		NO.	NO.			NO.	NO.
SCBP0440BN5	82679	27	104				
SCBP0440BN5	82679	31	6	SMB178480	80063	50	21
SC8P0440BN5	82679	32	21	SMB178483-1	80063	58	132
SC8P0440BN5	82679	66	31	SMB178486	80063	58	4
SCBP0440BN5	82679	68	33	SMB178491	80063	58	5
SCBP0440BN5	82679	69	41	SMB178702	80063	58	9
SCBP0440BN5	82679	71	3	SMB178707	80063	58	10
SCBP0440BN5	82679	72	43	SMB178739	80063	58	133
SC8176514	80063	3	28	SMB178752	80063	58	11
SC822795	80063	3	3	SMB178785	80063	58	12
SCC52943-3	80063	3	15	SMB178829	80063	58	14
SCD4195	80063	112	3				
SCD4195-1	80063	75	11	SMB178830	80063	58	15
SC04195-1	80063	112	1	SMB178861	80063	58	136
SCL692	81349	3	14	SMB178901	80063	58	17
SCH1068P010D4	01295	95	3	SMB178906	80063	58	18
SCM1068P020D4	96214	95	25	SMB178907	80063	58	19
SCH107HP00604	01295	95	16	SMB178912	80063	58	20
SCH107HP020D4	01295	100	15	SMB178913	80063	58	134
SCH157GP006D4	01295	95	2	SMB178935	80063	58	24
SCN157HP015D4	01295	101	9	SMB178957	80063	58	25
SCM337HP006D4	01295	100	7	SMB178977	80063	58	26
SC131-0632BN5	82679	31	10	SMB179030	80063	61	24
SC143-0440B8W	82679	27	56				
SC143-0832B12W	82679	20	25	SMB179050	80063	58	131
SC143-0832B8W	82679	20	45	SMB1800240	80063	80	2A
SC143-1032B12W	82679	70	30	SMB180188	80063	82	12A
SC143-1032B12w	82679	70	33	SMB180189	80063	82	12
SC143-2520B16W	82679	66	12	SMB180225	80063	80	16A
SC173-0632B10W	82679	16	37				
SGAPCM	82266	1	7	SMB180226	80063	80	16
SG15APCM	82679	1	7				
SG15APCM	82679	36	993	SMB180228	80063	80	8A
				SHB180228	80063	89	2
SK11	13499	48	1	SMB180228	80063	94	1
				SMB180229	80063	80	8
SMA179024	80063	61	36	SMB180231	80063	80	19A
SMA179028	80063	61	23	SMB180232	80063	80	19
SMB108888	80063	85	6	SMB180234	80063	80	26A
SMB108893	80063	85	15	SMB180235	80063	80	26
SMB108896	80063	85	14	SMB180237	80063	80	13A
SMB108905	80063	85	16	SMB180238	80063	80	13
SMB114043	80063	60	4	SMB180241	80063	80	2
SMB178414	80063	58	1	SMB180302	80063	75	3

Section IV. NATIONAL STOCK NUMBER AND PART NUMBER INDEX

PART NUMBER	FSCM	FIG ITEM		PART NUMBER	FSCM	FIG ITEM	
		NO.	NO.			NO.	NO.
SMB180305	80063	79	16	SMB180491	80063	75	15&
SMB180306	80063	79	13	SMB180491	80063	115	1:
SMB180323	80063	79	23	SMB180493	80063	TS75	16/i
SMB180329	80063	85	8	SMB180493	80063	115	10
SMB180332	80063	85	11	SMB248865	80063	58	30
SMB180335	80063	85	12	SMB248877	80063	58	31
SMB180396	80063	77	107	SMB248879	80063	58	3:
SMB180399	80063	77	135	SMB248880	80063	58	33
SMB180404	80063	77	97A	SMB248883	80063	58	128
SMB180405	80063	77	97	SMB248884	80063	58	34
SMB180408	80063	77	103	SMB248885	80063	58	35
SMB180410	80063	77	150	SMB248888	80063	58	36
SMB180413	80063	77	55	SMB248895	80063	58	37
SMB180416	80063	77	41	SMB248896	80063	58	38
SMB180418	80063	77	37A	SMB248900	80063	58	39
SMB180419	80063	77	37	SMB248902	80063	58	40
SMB180421	80063	77	207A	SMB248907	80063	58	41
SMB180422	80063	77	207	SMB248914	80063	58	42
SMB180424	80063	77	29A	SMB248920	80063	58	124
SMB180425	80063	77	29	SMB248921	80063	58	121
SMB180428	80063	77	219	SMB248924	80063	58	43
SMB180430	80063	77	213A	SMB248932	80063	58	71
SMB180431	80063	77	213	SMB248934	80063	58	44
SMB180440	80063	77	64	SMB248938	80063	S8	46
SMB180442	80063	77	160A	SMB248939	80063	58	47
SMB180443	80063	77	160	SMB248941	80063	58	48
SMB180445	80063	77	87A	SMB248942	80063	58	49
SMB180446	80063	77	87	SMB248943	80063	58	50
SMB180449	80063	77	75	SMB248944	80063	58	51
SMB180451	80063	77	22A	SMB248945	80063	58	52
SMB180452	80063	77	22	SMB248952	80063	58	55
SMB180455	80063	77	14	SMB248954	80063	58	116
SMB180457	80063	77	205A	SMB248953	80063	58	56
SMB180458	80063	77	205	SMB248956	80063	58	57
SMB180465	80063	76	30	SMB248957	80063	58	58
SMB180489	80063	75	17	SMB248958	80063	58	59
SMB180489	80063	115	11	SMB248963	80063	58	130
SMB180490	80063	75	7	SMB249038	80063	57	24
SMB180490-2	80063	75	11	SMB249065	80063	56	8

Section IV. NATIONAL STOCK NUMBER AND PART NUMBER INDEX

PART NUMBER	FSCM	FIG ITEM		PART NUMBER	FSCM	FIG ITEM	
		NO.	NO.			NO.	NO.
SMB249146	80063	58	120	SMB283221-4	80063	61	32
SMB249186	80063	58	73	SMB283227	80063	50	22
SMB249219	80063	52	41	SMB283227	80063	51	31
SMB249219	80063	53	39	SMB283227	80063	52	17
SMB249221	80063	50	19	SMB283227	80063	52	21
SMB249221	80063	61	10	SMB283227	80063	53	1{
SMB249225	80063	61	8	SMB283227	80063	53	26
SMB249228	80063	56	56	SMB283227	80063	54	11
SMB249229	80063	56	57	SMB283227	80063	55	14
SMB249230	80063	56	58	SMB283227	80063	56	39
				SMB283227	80063	57	34
SMB249231	80063	56	71	SMB283227	80063	60	10
				SMB283233	80063	61	3
SMB249233	80063	52	33	SMB283228-1	80063	52	60
				SMB283228-2	80063	55	8
SMB249233	80063	53	32	SMB283228-2	80063	55	9
				SMB283228-2	80063	55	11
SMB283169	80063	58	75	SMB283228-2	80063	55	12
				SMB283231	80063	57	13
SMB283171-1	80063	58	76	SMB283232	80063	56	22
				SMB283232	80063	57	14
SMB283171-2	80063	58	77	SMB283233	80063	57	1i
				SMB283234	80063	58	127
SMB283178	80063	52	16	SMB285236	0063	54	14
				SMB283236	80063	55	18
SMB283178	80063	53	17	SMB283237	80063	52	23
				SMB283237	80063	53	21
SMB283178	80063	54	16	SMB283237	80063	56	61
				SMB283238	80063	52	5
SMB283178	80063	55	20	SMB283238	80063	53	10
				SMB283238	80063	56	70
SMB283178	80063	57	12	SMB283239	80063	52	55
				SMB283243-1	80063	56	60
SMB283180	80063	56	33	SMB283262	80063	56	47
				SMB343586	80063	58	6
SMB283181	80063	50	9	SMB343594	80063	58	53
				SMB396929	80063	3	21
SMB283181	80063	56	32	SMB396931	80063	3	5
				SMB396942-8	80063	3	16
SMB283182	80063	56	1	SMB39697	80063	2	1
				SMB396980	80063	35	3
SMB283183	80063	50	10	SMB396981	80063	5	3
				SMB396982	80063	58	21
SMB283183	80063	56	31	SMB396983	80063	58	22
				SMB396984	80063	58	23
SMB283183	80063	60	6	SMB396985	80063	58	28
				SMB396986	80063	58	45
SMB283184	80063	51	11	SMB396987	B0063	58	54
				SMB396988	80063	58	67
SMB283184	80063	57	25	SMB396989	80063	58	72
				SMB396990	80063	58	82
SMB283187	80063	59	5	SMB396991	80063	58	89
				SMB396992	80063	58	90
SMB283195	80063	50	16	SMB396993	800863	58	91
				SMB396994	80063	58	94
SMB283195	80063	61	6	SMB396995	8063	58	98
				SMB396996	80063	58	105
SMB283198	80063	57	18	SMB396997	80063	58	106
				SMB396998	80063	58	107
SMB283200	80063	50	8	SMB396999	0063	58	108
				SMB397000	80063	58	109
SMB283200	80063	61	5	SMB397001	80063	58	110
				SMB397002	80063	58	111
SMB283221-1	80063	61	28	SMB397003	B0063	58	112
				SMB397004	80063	58	113
SMB283221-2	80063	61	31	SMB397005	80063	58	114
				SMB397006	80063	58	119

SMB283221-3

80063

61

33

SMB397007

80063

U8

1

339

Section IV. NATIONAL STOCK NUMBER AND PART NUMBER INDEX

PART NUMBER	FSCM	FIG ITEM		PART NUMBER	FSCM	FIG ITEM	
		NO.	NO.			NO.	NO.
SMB47610	80063	38	2	SMC180454	80063	77	14A
SMB47610	81351	90	2	SMC180471	80063	76	37
SMCCS31001	80063	118	6	SMC180471	80063	77	93
SMC107GP010D4	01295	95	20	SMC180502	80063	84	2
SMC108889	80063	8a	3	SMC180516	80063	84	8
SMC108895	80063	89	4	SMC248798	80063	59	1
SMC169374	80063	114	4	SMC248923	80063	58	115
SMC178505	80063	52	24	SMC248959	80063	58	60
SMC178505	80063	53	22	SMC248962	80063	58	63
SMC178505	80063	56	66	SMC248966	80063	s8	64
SMC178599	80063	57	27	SMC248967	80063	58	65
SMC178700	80063	58	7	SMC248968	80063	58	69
SMC178828	80063	58	13	SMC248971	80063	58	11;
SMC178855	80063	s8	135	SMC248971	80063	58	122
SMC179063	80063	58	27	SMC248971	80063	58	125
SMC180291	80063	83	3	SMC248972	80063	58	123
SMC180307	80063	77	9	SMC248972	80063	58	126
SMC180307	80063	79	2	SMC248977	80063	58	68
SMC180308	80063	77	179	SMC249043	80063	57	16
SMC180308	80063	79	10	SMC249045	80063	57	40
SMC180309	80063	77	83	SMC249112	80063	61	34
SMC180309	80063	79	3	SMC249195	80063	5li	74
SMC180330	80063	85	18	SMC249216	80063	56	81
SMC180337	80063	85	13	SMC249217	80063	li6	46
SMC180368	80063	77	8	SMC249217	80063	57	42
SMC180369	80063	76	35	SMC249218	80063	56	63
SMC180395	80063	77	107A	SMC249220	80063	52	13
SMC180390	80063	77	135A	SMC249220	80063	53	13
SMC100401	80063	77	143A	SMC249222	80063	61	35
SMC180402	80063	77	143	SMC249223	80063	61	22
SMC180409	80063	77	150A	SMC249232	80063	52	31
SMC180415	o0063	77	41A	SMC249232	80063	53	31
SMC180427	80063	77	219A	SMC249244	80063	56	3E
				SMC249244	80063	S6	6A
SMC180434	80063	77	168	SMC283177	\$0063	s0	13
SMC180436	80063	77	182A	SMC283177	80063	61	16
SMC180437	80063	77	182	SMC283179	80063	s0	7
SMC180439	80063	77	64A	SMC283188	80063	S2	20
SMC180448	80063	77	75A	SMC283188	80063	53	20

SECTION IV. NATIONAL STOCK NUMBER AND PART NUMBER INDEX

PART NUMBER	FSCM	FIG. NO.	ITEM NO.	PART NUMBER	FSCM	FIG. NO.	ITEM NO.
SMC283188	80063	54	15	SMC343601	80063	58	69
SMC283188	80063	5S	19	SMC343621	80063	53	
SMC283189	80063	61	4	SMC343625	80063	52	56
SMC283191	80063	51	14	SMC343628	80063	56	19
SMC283191	80063	59	3	SMC343630	80063	56	20
SMC283191	80063	63	17				
SMC283192	80063	61	1	SMC343631	80063	56	30
SMC283194	80063	91	13	SMC343632	80063	56	7
SMC283203	80063	61	19	SMC383192	80063	so	23
SMC283204-1	80063	61	7	SMC396981	80063	3	20
SMC283204-2	80063	61	15	SMC31001	80063	118	1
SMC283206	80063	62	1A	SMC531001	80063	118	2
SMC283216	80063	61	37	SMC531001	80063	118	3
SMC283217	80063	61	17	SMC531001	80063	118	4
SMC283217	80063	75	1	SMC531001	80063	118	5
SMC283217	o0063	76	32	SMC96980	80063	3	12
SMC283217	80063	79	8	SMD108908	80063	85	9
SMC283218	80063	51	1	SMD180166-2	80063	84	6
SMC283219	80063	51	S	SMD180166-3	80063	84	7
SMC283220	80063	51	4	SMD180166-4	80063	84	4
SMC283226-16	80063	56	38	SMD180166-5	80063	84	5
SMC283226-16	80063	57	39	SMD180170	80063	76	41
SMC283235	80063	S6	64	SMD180183	80063	82	17
SMC283240	80063	61	18	SMD180201	80063	82	26
SMC283241-1	80063	52	1	SMD180300	80063	75	2E
SMC283241-1	80063	53	18	SMD180300-2	80063	75	14
SMC283241-2	80063	51	28	SMD180300-2	80063	77	177
SMC283241-2	80063	51	37	SMD180300-2	80063	79	14
SMC283241-2	80063	52	19	SMD180310	80063	79	22
SMC283241-2	80063	53	34	SMD100327	80063	76	21
SMC283241-2	80063	53	44	SMD180327	80063	77	127
SMC283241-3	80063	51	34	SMD180327	80063	79	21
SMC283241-3	80063	52	32	SMD180327	80063	8a	1A
SMC283244	80063	51	12	SMD180328	80063	85	10
SMC283279	80063	51	6	SMD180343	80063	77	IS6A
SMC283276	80063	51	8	SMD180343-47	80063	77	55A
SMC343590	80063	58	137	SMD180495	80063	75	18
SMC343591	80063	58	16	SMD180512	80063	84	1
SMC343597	80063	58	61	SMD248860	80063	92	36
SMC343598	80063	58	62	SMD248860	80063	53	40

SECTION IV. NATIONAL STOCK NUMBER AND PART NUMBER INDEX

PART NUMBER	FSCM	FIG. NO.	ITEM NO.	PART NUMBER	FSCM	FIG. NO.	ITEM NO.
SMD248860	80063	54	13	SMD249236	80063	57	11
SMD248860	80063	55	15	SMD249237	80063	54	17
SMD248861	80063	52	40	SMD249237	80063	55	21
SMD248861	80063	53	41	SMD249238	80063	54	3
SMD248861	80063	54	7	SMD249238	80063	55	3
SMD248861	80063	55	6	SMD249239	80063	54	2
SMD248862	80063	52	42	SMD249239	80063	55	2
SMD248862	80063	53	43	SMD343600-10	80063	58	78
SMD248862	80063	54	6	SMD343600-2	80063	58	83
SMD248862	80063	55	17	SMD343600-3	80063	58	84
SMD248863	80063	52	37	SMD343600-4	80063	58	85
SMD248863	80063	53	38	SMD343600-5	80063	58	86
SMD248863	80063	54	9	SMD343600-6	80063	58	87
SMD248863	80063	55	10	SMD343600-7	80063	58	8
SMD249007	80063	57	17	SMD343600-7	80063	58	88
SMD249086	80063	56	18	SMD343612	80063	58	70
SMD249087	80063	56	17	SMD343619	80063	50	6
SMD249088	80063	56	16	SMD343622-1	80063	50	3
SMD249089	80063	56	25	SMD343623	80063	61	40
SMD249090	80063	56	24	SMD343626	80063	60	3
SMD249091	80063	56	23	SMD343629	80063	56	21
SMD249092	80063	56	15	SMD349082-1	81351	102	2
SMD249093	80063	56	14	SMD14PNSS	30194	30	7
SMD249094	80063	56	13	SMD14PNSS	30194	30	8
SMD249095	80063	56	29	SN74L86N	01295	73	18
SMD249096	80063	56	28	SN7400N	09134	18	59
SMD249097	80063	56	27	SN7400N	09134	73	12
SMD249098	80063	56	6	SN7404N	01295	66	26
SMD249099	80063	56	3	SN7404N	01295	73	14
SMD249100	80063	56	12	SN7405N	01295	73	16
SMD249131	80063	50	5	SN74154N	01295	73	15
SMD249132	80063	50	1	SN74155N	01295	73	60
SMD249134	80063	61	38	SN74184N	02195	73	17
SMD249234	80063	52	25	SN7470N	01295	66	27
SMD249234	80063	53	25	SN7473N	01295	73	19
SMD249234	80063	54	10	SN7490N	02195	17	45
SMD249234	80063	55	13	SN7490N	02195	19	44
SMD249235	80063	56	5	SN7490N	01295	66	6
SMD249236	80063	56	11	SN7490N	01295	73	11

SECTION IV. NATIONAL STOCK NUMBER AND PART NUMBER INDEX

PART NUMBER	FSCM	FIG. NO.	ITEM NO.	PART NUMBER	FSCM	FIG. NO.	ITEM NO.
SOMES55	88947	89	1	TMD2	83125	48	3
SOMES55VU	88947	89	3	TRANSFORMER95-2	88183	95	21
				1			
SP67	81349	103	16	TRC500	82679	3	10
				TSECKW26	82679	1	22
SRD10-15	82679	43	1	TSECKW26	82679	107	1
				TSECKW7	82679	1	13
ST22	81349	83	10	TSECKW7	82679	42	993
ST22N	82679	10	3				
ST22N	82679	29	33	TS101P01	81349	51	19
ST22N	81349	81	7	TS101P01	81349	78	13
				TS101P01	81349	82	8
				TS101P02	81349	37	11
				TS101P02	81349	92	4
S0-239	80063	7	1	TS101P02	81349	98	11
S0-239	80063	8	1	TS101P02	81349	102	4
S0-239	81349	36	1	TS101P02	81349	104	10
S1006-20	03522	106	6	TS102P01	81349	51	17
S1083	03522	106	5	TS102P01	81349	52	2
S1309	03522	106	4	TS102P01	81349	56	43
S1364	03522	106	1	TS102P01	81349	57	36
S1365	03522	106	2	TS102P01	81349	60	7
S2006	03522	106	3	TS102P01	81349	76	17A
S202CCT	07233	37	1	TS102P01	81349	82	9
S202CCT	07233	92	12	TS103P01	81349	51	21
S202CCT	07233	98	20	TS103P01	81349	52	10
S6122	05580	4	24	TS103P01	81349	52	53
TAC220S02	82679	44	4	TS103P01	81349	53	4
TA312PT	82679	1	11	TS103P01	81349	53	29
TA312PT	82679	39	993	TS103P01	81349	54	21
TA43PT	82679	1	10				
TA43PT	82679	39	991	TS103P01	81349	55	25
TDR002.5	79615	3	7	TS103P01	81349	56	77
TS103P01	81349	56	82				
TE1102	56289	48	16	TS103P01	81349	59	4
TE115-2	82679	63	7	TS103P01	81349	76	22A
TE115-2	92825	63	13	TS103P01	81349	78	12
TF0352	82679	30	15	TS106DGG	82679	1	28
TF154-2C24VDC	02288	29	109	TS1100U	82679	1	29
TF154-4C12VDC	02288	96	-				
TF372	82679	65	23	TS1194U	82679	1	30
TGP10	56289	100	37				
TGP10.33C41	56289	102	13	TS153-1	82679	29	30
TGS10	56289	100	14	TS153-5	82679	29	29
TGS10	56289	102	12	TS153-9	82679	65	12

SECTION IV. NATIONAL STOCK NUMBER AND PART NUMBER INDEX

PART NUMBER	FSCM	FIG. NO.	ITEM NO.	PART NUMBER	FSCM	FIG. NO.	ITEM NO.
TS154-4	82679	65	10	TT286-6	82679	15	37
TS1836U	82679	1	31	TT286-8	82679	14	39
TS2TG	82679	1	27	TT286-8	82679	15	38
TS3528U	82679	1	25	TT287-10	82679	26	59
TS384	85008	81	14	TT287-12	82679	26	49
TS385	85008	81	10	TT287-13	82679	24	25
TT285-10	82679	27	19	TT287-14	82679	24	20
TT285-11	82679	13	17	TT287-15	82679	24	27
TT285-11	82679	22	10	TT287-19	82679	24	29
TT285-12	82679	13	17A	TT287-19	82679	26	65
TT285-15	82679	13	178	TT287-20	82679	24	32
TT285-16	82679	16	5	TT287-21	82679	26	63
TT285-17	82679	17	41	TT287-3	82679	24	36
TT285-17	82679	19	25	TT287-4	82679	24	35
TT285-18	82679	18	56	TT287-9	82679	26	51
TT285-2	82679	17	36	TT307-1	82679	73	3
TT285-2	82679	18	5	TT307-10	82679	72	10
TT285-2	82679	19	5	TT307-11	82679	68	20
TT285-2	82679	27	29	TT307-12	82679	68	22
TT285-22	82679	13	60	TT307-13	82679	68	16
TT285-23	82679	13	55	TT307-14	82679	73	8
TT285-3	82679	17	42	TT307-15	82679	73	5
TT285-3	82679	18	32	TT307-16	82679	63	31
TT285-3	82679	19	19	TT307-16	82679	73	7
TT285-4	82679	17	44	TT307-2	82679	73	4
TT285-4	82679	18	27	TT307-3	82679	73	78
TT285-4	82679	19	28	TT307-4	82679	73	21
TT285-4	82679	27	64	TT307-5	82679	73	6
TT285-6	82679	18	16	TT307-6	82679	73	9
TT285-7	82679	18	25	TT307-7	82679	69	8
TT286-14	82679	23	41	TT307-8	82679	67	9
				TT307-9	82679	72	39
TT286-15	82679	23	28	TT308	82679	69	7
				TT308	82679	70	1
TT286-16	82679	23	31	TT309	82679	69	12
				TU17	82679	3	53
TT286-2	82679	14	32	TV7DU	82679	1	32
TT286-2	82679	15	31	TYPE315-10	09134	29	1
TT286-2	82679	23	55	TYPE315-10	09134	73	58
TT286-4	82679	14	37	TYPE315-47	09134	30	5
TT286-4	82679	15	36	TZ215-1	82679	27	71
TT286-6	82679	14	38	TZ215-10	82679	26	46

SECTION IV. NATIONAL STOCK NUMBER AND PART NUMBER INDEX

PART NUMBER	FSCM	FIG. NO.	ITEM NO.	PART NUMBER	FSCM	FIG. NO.	ITEM NO.
TZ215-11	82679	26	74	UL914	07263	16	46
TZ215-12	82679	25	4	UP1Z1N	96906	37	2
TZ215-2	82679	28	18	UP121H	96906	92	11
TZ215-3	82679	28	16	UP121	81349	98	6
TZ215-4	82679	28	3	UP12NH	81349	104	5
TZ215-6	82679	26	80	UTCD1T260	80223	22	42
7Z215-8	82679	26	73	UX5995829X	07263	23	63
TZ216	82679	6	55	U18992328X	07263	13	7
TZ218	82679	16	s8	WA109-35	82679	66	32
TZ219	82679	20	21	WA109-35	82679	68	34
TZ220	82679	20	44	WA109-35	82679	71	4
TZ220	82679	27	52	WA109-35	82679	72	44
TZ221	82679	24	40	WA109-43	82679	16	36
TZ222	82679	23	46	WA109-52	82679	20	24
T2150	81640	96	1	WA109-52	62679	27	55
T2150-28V	82389	49	6M	WA109-54	82679	70	31
T600	90303	92	10	WA109-54	82679	70	34
T600	76149	94	3	WA109-55	82679	66	13
				WCS9S STYLE N42	1349	77	130
T600	76149	98	9	WEC0239A	70674	47	2
T600	76149	104	11	WEE1-2UH	83125	72	17
UGC7805	33888	65	5	WEE1-SUH	63125	72	20
UGH7812	33888	65	7	WEE1UH	83125	27	67
				WEE1UH	83125	28	29
				WEE1UH	83125	68	19
UG290U	81349	83	12	WEE1UH	83125	72	23
UCG492U	80058	10	1	WEE10MH	83125	69	9
				WEE10MH	83125	70	15
				WEE10MH	83125	74	20
UC625U	80058	29	63	WEE10UH	83125	25	10
UG625U	80058	65	2	WEE10UH	83125	16	2
UC88CU	81349	75	6	WEE100UH	83125	67	15
UC88CU	82679	115	8	WEE100UH	83125	72	25
UG88U	80058	10	2	WEE1000UH	13125	13	27
UGMU	80058	29	110				
UG94A	96906	3	33	WEE1000UH	83125	16	62
UC95AN	96906	3	32	WEE1000UH	8312S	22	53
				WEE12UH	83125	23	14
				WEE12U	83125	24	42
UK105	71590	103	6	WEE12UN	83125	26	68
UK225	71590	99	11	WEE12UN	83125	63	26

SECTION IV. NATIONAL STOCK NUMBER AND PART NUMBER INDEX

PART NUMBER	FSCM	FIG. NO.	ITEM NO.	PART NUMBER	FSCM	FIG. NO.	ITEM NO.
WEE12UH	83125	73	34	WEE47UH	83125	25	27
WEE120UH	83125	14	35	WEE56UH	83125	74	18
WEE120UH	83125	15	34	WEE68UH	83125	29	71
WEE120UH	83125	17	49	WEE8-2UH	83125	17	43
WEE120UH	83125	18	21	WEE8-2UH	83125	18	24
WEE120UH	83125	19	39	WEE8-2UH	83125	19	20
WEE120UH	83125	20	31	WEE8-2UH	83125	27	28
WEE120UH	83125	23	3	WEE8-2UH	83125	29	84
WEE120UH	83125	24	15	WEE82UH	83125	26	41
WEE120UH	83125	25	11	WEE82UH	83125	27	85
WEE120UH	83125	26	56	WEE82UH	83125	72	14
WEE120UH	83125	27	41	WE0.82UH	83125	29	10
WEE120UH	83125	28	24	WKJ06D26-5VDC	02288	87	5
WEE120UH	83125	29	2	WKJ06D26-SVDC	02288	88	5
WEE120UH	83125	30	4	WKJ06D48VDC	02288	29	58
WEE120UH	83125	66	7	W134012	82679	115	15
WEE120UH	83125	68	15	XK LX	71400	104	13
WEE120UH	83125	69	11	X1457B	71279	13	4
WEE120UH	83125	72	36	X14578	71279	14	10
WEE120UH	83125	73	20	X14578	71279	15	10
WEE120UN	83125	74	8	X14578	71279	16	8
WEE15UH	83125	17	46	X14578	71279	17	39
WEE15UH	83125	19	46	X14578	71279	18	9
WEE15UH	63125	67	17	X14578	71279	19	2
WEE15UH	83125	74	3	X14576	71279	22	8
WEE2-2UH	83125	20	29	X14578	71279	23	5
WEE22UH	83125	27	37	X14578	71279	27	2
WEE22UH	83125	28	28	X14578	71279	65	34
WEE22UH	83125	29	7	X14578	71279	69	1
WEE220UH	83125	13	61	X663F-105-200-2	92741	30	18
WEE220UH	83125	16	61	0			
WEE220UH	83125	17	47	ZZNW810L6-L0S	49367	111	3
WEE220UH	83125	19	42	ZZHWF81716	49367	6	1
WEE220UH	83125	22	50	ZZLMF5616	49367	6	2
WEE220UH	83125	24	44	ZZHW24121550	49367	111	1
WEE330UH	83125	22	14	ZZMW2416-1850	49367	111	4
WEE39UH	83125	27	83	ZZMW7516	49367	6	3
WEE39UH	83125	29	52	0-2552	21937	76	34
WEE47UH	83125	25	13	0-429-4	60399	84	10
				0A2	81349	82	6

SECTION IV. NATIONAL STOCK NUMBER AND PART NUMBER INDEX

PART NUMBER	FSCM	FIG. NO.	ITEM NO.	PART NUMBER	FSCM	FIG. NO.	ITEM NO.
OK4-171	49367	111	2	0831-000Z5V0010 2P	18796	67	2
OS8U	82679	4		0831-000Z5V0010 2P	18796	72	29
028021	82877	34	2	0831-000Z5V0010 2P	18796	73	53
05W	00628	45	3	0831-00Z5V0010 2P	18796	74	1
0801000X5V00222 P	18796	27	9	0861-000X5R0010 1K	18796	23	19
0805024X5V00103 H	18796	87	3	0861-000X5R0010 1K	18796	24	11
0805024X5V00103 H	18796	88	3	0861-000X5R0010 1K	18796	25	1
0805024X5V00103 M	18796	66	5	0861-000X5R0010 1K	18796	26	5
0805024X5V00103 M	18796	67	3	0861-000X5R0010 1K	18796	27	17
0805024X5V00103 M	18796	68	3	0861-000X5R0010 1K	18796	28	7
0805024X5V00103 M	18796	69	18	0861-000X5R0010 1K	18796	29	18
0805024X5V00103 M	18796	70	11	1N100	81349	20	20
0805024X5V00103 M	18796	72	4	1N100	81349	32	15
0805024X5V00103 M	18796	73	40	1N100	81349	65	35
0805024X5V00103 M	18796	74	5	1N100	81349	69	26
0805024X5V00103 P	18796	14	19	1N100	81349	70	2
0805024X5V00103 P	18796	15	19	1N100	81349	73	30
0805024X5V00103 P	18796	20	1	1N1763	80131	48	11
0805024X5V00103 P	18796	23	2	1N2484	81349	30	16
0805024X5V00103 P	18796	29	3	1N2484	81349	30	17
0805024X5V00103 2P	18796	13	53	1N276	81349	99	27
0805024X5V00103 2P	18796	14	22	1N2986B	81349	65	28
0805024X5V00103 2P	18796	15	21	1N34	81349	29	17
0805024X5V00103 2P	18796	16	20	1N34A	81349	13	41
0805024X5V00103 2P	18796	17	1	1N34A	81349	16	16
0805024X5V00103 2P	18796	18	1	1N4619	81349	32	12
0805024X5V00103 2P	18796	19	12	1N4864	81349	18	50
0805024X5V00103 2P	18796	20	27	1N4864	81349	20	30
0805024X5V00103 2P	18796	23	7	1N4864	81349	27	61
0805024X5V00103 2P	18796	24	1	1N5256B	81349	71	6
0805024X5V00103 2P	18796	25	3	1N538	81349	39	7
0805024X5V00103 2P	18796	26	7	1N538	81349	100	16
0805024X5V00103 2P	18796	27	4	1N627	81349	16	42
0805024X5V00103 2P	18796	28	25	1N627	81349	26	19
0805024X5V00103 2P	18796	29	8	1N627	81349	29	14
0805024X5V00103 2P	18796	29	16	1N645	81349	100	8
0805024X5V00103 2P	18796	29	40	1N645	82679	103	3
0805024X5V00103 2P	18796	29	60	1N705A	73293	100	33

SECTION IV. NATIONAL STOCK NUMBER AND PART NUMBER INDEX

PART NUMBER	FSCM	FIG. NO.	ITEM NO.	PART NUMBER	FSCM	FIG. NO.	ITEM NO.
1N746A	81349	13	8	12-164	71785	96	6
1N750A	81349	23	52	12K	81349	45	16
1N751	81349	18	62	12100017000	20418	35	2
1N752	81349	17	48	12225001008	20418	35	7
1N752	81349	19	40	13036	82389	10	5
1N753A	81349	32	4	136-126	74970	3	22
1N753A	81349	102	7				
1N754A	81349	16	26	14T24324	07233	100	27
1N754A	81349	99	8	1400	72512	48	2
1N754A	81349	100	32	14090001000	20418	35	6
1N755A	81349	16	43	14633	71785	84	9
1N756A	81349	68	5	14634	71785	83	14
1N759A	81350	63	27	155A3	11700	66	22
1N914	81349	16	54	155CCCC	02288	96	8
158	82679	3	45				
1N914	81349	18	61	16-164	71785	96	10
1N914	81349	24	7	16-164	71785	113	1
1N914	81349	26	18	165D	64959	4	18
16844G1	82679	3	52				
1N914	81349	27	43	17106	70903	113	2
1N914	81349	66	2	17106	70903	116	2
1N914	81349	69	24	18-140-34W	07233	98	21
1N914	81349	73	38	18-140-34W	07233	104	20
1N933	81349	50	12	186P10301S5	56289	76	29
1N933	81349	61	14	186P1040512	56289	77	201
1N972B	81349	32	18	186P10401S512	56289	76	33
1SM1	91929	85	5	186P10401S12	56289	77	66
10F10-OHN	12697	65	24	186P10401S512	56289	77	203
10F2000	63743	49	3	186P10401S512	56289	77	223
10F2250	63743	49	2	186P10401S5	56289	76	1
10F50-OHN	12697	65	15	186P10402S12	56289	77	46
10015579-193	81349	45	10				
1042C	72563	43	2	186P10402S5	56289	76	18
1045C	72563	43	3	186P10404S512	56289	77	60
1047-417D	97983	3	29	186P10404S12	56289	77	111
1047-417014	97983	3	9	186P10404S512	56289	77	140
1047-417016	97983	3	23	186P10404S512	56289	77	155
1047-41705	97983	3	37	186P10404S512	56289	77	163
1047-427C2	82679	111	5				
106234	98230	107	2	186P10404S512	56289	77	166
11X574	96906	77	180	186P10404S5	56289	76	5
112	76385	29	82	186P10404S5	56289	76	8
11726-136	80503	76	31	186P47301S12	56289	77	67
11726-136	80503	77	121	186P473015S12	56289	80	6

SECTION IV. NATIONAL STOCK NUMBER AND PART NUMBER INDEX

PART NUMBER	FSCM	FIG. NO.	ITEM NO.	PART NUMBER	FSCM	FIG. NO.	ITEM NO.
186P4730155	56289	76	2	2N3646	81349	17	38
186P47301S5	56289	76	19	2N3646	81349	18	12
196P10401S13	56289	77	47	2N3646	81349	19	10
196P10404S11	56289	77	73	2N3646	81349	22	7
196P10404513	56289	77	74	2N3646	81349	23	25
196P10404S13	56289	77	80	2N3646	81349	24	2
196P10406S11	56289	81	4	2N3646	81349	25	18
196P47304S13	56289	77	11	2N3646	81349	26	17
196P47304S13	56289	77	21	2N3646	81349	27	3
199-2-3-0300	97983	39	10	2N3646	81349	28	2
199-2-3-0330	97983	41	3	2N3646	81349	68	8
28	17870	29	26	2N5070	81349	20	14
2BL63	76385	65	22	2N5179	81349	26	2
2EB4128	03522	106	7	2N5179	81349	27	18
2N1011	81349	100	20	2N5179	81349	28	14
2N1132	81349	70	25	2N652A	94990	99	6
2N1308	81349	70	22	2N652A	94990	99	30
2N1481	81349	32	9	2N652A	94990	100	3
2N1488	82679	29	79	2N652A	81349	101	6
2N1711	81349	16	23	2N652A	94990	102	10
2N1711	81349	65	38	2N652A	81349	103	12
2N1711	81349	71	10	2N696	81349	16	19
2N2368	81350	63	36	2N916	81349	45	12
2N2368	81349	66	3	2TS4	07233	48	10
2N2368	81349	67	14	2027GB	79725	4	8
2N2368	81349	69	5	20905FR	04009	39	4
2N2368	81349	70	10	21-164	71785	117	1
2N2368	81349	72	5	211Z12	88183	95	33
2N2368	81349	73	2	211Z13	88183	95	32
2N2368	81349	74	4	211Z14	88183	95	31
2N3055	81349	65	30	211Z15	88183	95	30
2N307	80131	48	4	211Z4	88183	95	37
2N3296	81349	20	46	211Z5	88183	95	36
2N3375	81349	20	7	211Z6	88183	95	35
2N3638	81349	32	2	211Z7	88183	95	34
2N3646	81349	13	14	212	88183	101	23
2N3646	81349	14	13	2127D	79725	4	21
2N3646	81349	15	13	2127GA	79725	4	6
2N3646	81349	16	12	2127GA	79725	116	1

SECTION IV. NATIONAL STOCK NUMBER AND PART NUMBER INDEX

PART NUMBER	FSCM	FIG. NO.	ITEM NO.	PART NUMBER	FSCM	FIG. NO.	ITEM NO.
2127GB	79725	4	7	3A1A1	71279	88	2
22T3R9-000K	68995	20	41	3X1076SK	74193	108	9
220P02	82679	44	5	30-315	72143	103	1
221MODEL1	74130	92	17	3017TC	79725	4	3
22186G1	82679	3	51	303A	90044	97	3
22187G2	82679	3	50	3086	79725	4	1
223-1117	82679	44	6	3089E	79725	4	2
223-1217	82679	44	4	312.175	75915	49	8
22301G1	82679	3	49	315-824A5	09134	20	3
22302G1	82679	3	44	3250P1-102	32997	16	24
22448G1	82679	3	47	3250P1-103	32997	16	27
22452G1	82679	3	46	3263SMG4LC	74193	75	8
227MOD1	88183	37	7	3263SMG4LC	74193	81	13
231-8-1	92755	3	13	327	85599	29	34
234	88183	94	4	330	85599	65	11
2418	64959	4	22	342003	75915	48	6
2418	64959	4	23	344.125	75915	49	7
2418	64955	114	5	347-3	80252	39	5
24505G1	82679	3	48	35-1824-3	18915	29	108
2454	08097	3	35	35-1825-3	18915	29	21
25020006000	20418	35	12	35TR100	14841	39	8
251	31669	13	49	36D223G015AC2A	56289	65	29
26-4201-8S	02660	37	8	360-70	71688	109	1
26-4201-85	02660	92	1	373A	64959	4	17
26-4201-8S	02660	98	1	3857000Z5V00104	18796	30	1
26-4201-8S	02660	104	1	Z			
2625W	81349	59	2	39D157G075FJ4	56289	30	9
26408-1137	72619	37	13	39D15207G075FJ4	56289	31	1
26408-1137	26408	92	15	390207G050FJ4	56289	31	3
26408-1137	72619	98	17	39000002000	20418	35	5
26408-1137	72619	104	16	39020128000	20418	35	8
265431F5X	76854	29	62	4-19008TYPE 1	99028	45	13
265432F2X	76854	29	61	4-19009	99028	45	8
265434F2	76854	29	42	4-74-6	95263	108	6
265435F1	76854	29	98	40C258	56289	102	8
265436F1	76854	29	93	404A1	82679	43	991
265439F2X	76854	29	64	40841	82679	66	19
265440F1X	76854	29	63	40841	82679	68	14
265443F3	76854	29	68	40841	82679	69	10
27030003002	20418	35	4	40841	82679	72	41
271016	82877	34	3				
275MODEL 1	74130	100	22				
29435	29435	3	34				
29534	90190	3	2				
3-331677-2	99028	45	9				
3A1A1	71279	87	4				

SECTION IV. NATIONAL STOCK NUMBER AND PART NUMBER INDEX

PART NUMBER	FSCM	FIG. NO.	ITEM NO.	PART NUMBER	FSCM	FIG. NO.	ITEM NO.
40841	82679	73	10	5384	75582	43	7
41TB8	81349	50	11	5384	75582	45	1
41TB8	81349	61	2	5418	03040	80	1
410C	90044	97	2	5418	03040	81	3
41000005000	20418	35	1	541C	03040	80	7
41000095000	20418	35	9	541C	03040	81	1
41005009000	20418	35	11	55668	74545	4	13
44	72825	5	3				
4405	71400	95	14	557-06	72982	52	38
451A	03040	80	5	5651	81349	82	4
451A	03040	81	2	5654-6AK5W	81349	56	9
453E1005	56289	32	7	5654-6AKSW	81349	57	19
47	24446	75	10	57-10140	02660	92	7
47	24455	75	15	57-10140	02660	93	4
47	24455	75	16	57-10140	02660	93	5
478031	82877	34	1	57-10140	02660	95	17
5-67261-510	76854	65	26	57-10140	02660	98	5
5F150HM	12697	30	11	57-10140	02660	99	29
5H501M	08313	99	3	57-10140	02660	100	21
5R4WGY	81349	82	2	57-10140	02660	101	12
5082-2900	28480	27	82	57-10140	02660	104	4
5261	83315	4	9	57-20140	02660	93	1
538-002-1100	18796	18	49	57-20140	02660	93	8
538-002-1100	18796	23	8	57-20140	02660	98	3
538-002-110D	18796	25	21	57-20140	02660	104	3
538-002-110D	18796	26	23	5720140	02660	92	3
538-002-1100	18796	27	78	5726	81349	76	17
538-002-112F	18796	22	41	5749-6BA6W	81349	54	5
538-002-112F	18796	25	6	5749-6BA6W	81349	55	5
538-002-89A	18796	27	74	5751WA	81349	76	15
538-002-89A	18796	28	6	5814A	81349	51	9
538-002-908	18796	26	10	5814A	81349	54	4
538-002-92A	18796	14	14	5814A	81349	55	4
538-002-92A	18796	15	14	5814A	81349	56	10
538-002-92A	18796	26	25	5814A	81349	76	3
538-002-92A	18796	28	23	5815-200Y5U0204	18796	13	21
				Z			
538-006-112F	18796	23	12	5815-200Y5U0204	18796	16	57
				Z			
538-011-110D	18796	14	11	5815-200Y5U0204	18796	23	18
				Z			
538-011-1100	18796	15	11	5815-200Y5U0204	18796	27	7
				Z			
538-011-1100	18796	68	30	5815-200Y5U0204	18796	29	9
				Z			

SECTION IV. NATIONAL STOCK NUMBER AND PART NUMBER INDEX

PART NUMBER	FSCM	FIG. NO.	ITEM NO.	PART NUMBER	FSCM	FIG. NO.	ITEM NO.
581500CY5U00104 2	18769	70	4	62P500	80740	191	
5835000Y5U00203 Z	18796	63	23	62P500	80740	24	30
6-141	71785	83	5	62P500	80740	26	66
6-141Y	71785	83	8	62P500	80740	27	66
6-141Y	71785	83	11	62P500	80740	28	21
6AK6	81349	51	7	62P5000	80740	13	59
6AK6	81349	54	1	62P5000	80740	20	12
6AK6	81349	55	1	62P5000	80740	23	54
6AQ5WA	81349	76	40	634D	82389	1	33
6AU6	81349	82	5	64015048000	20418	35	10
6AU6WB	81349	76	13	6410-1	95712	29	78
6BA7	81349	76	22	6411-1	95712	30	3
6C4	81349	56	4	6808	74545	83	9
6DC6	81349	56	26	693	88183	92	6
6U8A	81349	76	10	693	88183	94	2
6X4W	81349	82	7	693	88183	98	7
600AY6	75382	29	76	693	88183	104	6
600AY6	75382	65	1	7-0332	88183	93	3
600A4	75382	10	6				
6080	81349	82	3	7-0332	88183	99	24
62F305	01002	32	6	7-0332	88183	100	36
7-0332	88183	101	21				
62P10K	80740	20	4	7057	74545	75	12
62P10K	80740	22	45	7057	74545	112	5
62P10K	80740	32	8	7092	74545	4	5
62P100	80740	13	22	7092	74545	113	3
62P100	80740	16	60	72A0Z160TGTC	78277	49	4
62P100	80740	22	6	72A0Z160TSTCP	78277	102	3
62P100	80740	24	39	72108	74545	4	11
62P100	80740	26	64	7259	74545	75	9
62P100	80740	27	47	7259	74545	112	2
62P1000	80740	13	23				
62P1000	80740	32	1	73168TYPEK	73168	39	6
62P2000	80740	27	35	7410-B	74545	4	12
62P25K	80740	16	51	74108	74545	116	3
62P500	80740	13	51	750	88183	93	2
62P500	80740	14	34	751	88183	93	6
62P500	80740	15	33	75535	80063	3	40
62P500	80740	17	35	7610K2	15605	4	26
62P500	80740	18	29	77MIP8	02660	30	2

SECTION IV. NATIONAL STOCK NUMBER AND PART NUMBER INDEX

PART NUMBER	FSCM	FIG. NO.	ITEM NO.	PART NUMBER	FSCM	FIG. NO.	ITEM NO.
8000AG10	91506	14	6	95-457	72619	96	2
8000AG10	91506	15	6	95-937	72619	39	3
805031X5V103M	18796	22	20	95-937	72619	44	1
8131M103X5V0104	18796	13	15	95-937	72619	96	4
Z							
8131M103X5V0104	18796	16	59	95-37-72619	72619	96	5
Z							
8131M103X5V0104	18796	22	3	95026	32699	3	27
Z							
8131M103X5V0104	18796	24	12	9534	90190	3	18
Z							
8131M103X5V0104	18796	27	13	9541BB0632-4	06540	63	29
Z							
8131M103X5V0104	18796	29	5	9711	74545	4	27
Z							
8131M103X5V0104	18796	29	69	9726A0440	06540	45	6
Z							
8131M103X5V0104	18796	66	8	9754	74545	39	9
Z							
8131M103X5V0104	18796	67	7	9754	74545	41	2
Z							
8131M103X5V0104	18796	68	13	9766-28BLACK	00629	5	2
Z							
8131M103X5V0104	18796	69	22				
Z							
8131M103X5V0104	18796	70	8				
Z							
8131M103X5V0104	18796	72	37				
Z							
8131M103X5V0104	18796	73	56				
Z							
8131M103X5V0104	18796	74	14				
Z							
8131M103X5V0104	18796	63	24				
2							
8131M103X5V2003	18796	14	7				
I							
8131M103X5V2003	18796	15	7				
I							
8131M103X5V2003	18796	18	47				
I							
8131M103X5V2003	18796	23	1				
I							
82679 SHELTER	82679	4					
83J9	02660	36	3				
831-000X5P0-471	18796	25	15				
K							
833	2212	43	4				
84200025U2X103P	18796	29	22				
8453	70903	43	8				
8453	70903	45	4				
88100	73569	3	24				
9-0163-009	81030	65	13				
9F	77554	3	41				
90S08X	90044	49	9				
9200	74545	4	10				
9350-10	74693	20	2				
9530-10	74693	20	37				
9350-10	74693	29	77				
95-457	72619	39	1				
95-457	72619	44	2				

*U.S. GOVERNMENT PRINTING OFFICE: 1983-664-028/6026

RECOMMENDED CHANGES TO EQUIPMENT TECHNICAL PUBLICATIONS



SOMETHING WRONG WITH THIS PUBLICATION?

FROM: (PRINT YOUR UNIT'S COMPLETE ADDRESS)

DATE SENT

PUBLICATION NUMBER

PUBLICATION DATE

PUBLICATION TITLE

BE EXACT... PIN-POINT WHERE IT IS

PAGE NO.

PARA-GRAPH

FIGURE NO.

TABLE NO.

IN THIS SPACE TELL WHAT IS WRONG AND WHAT SHOULD BE DONE ABOUT IT:

TEAR ALONG PERFORATED LINE

PRINTED NAME, GRADE OR TITLE, AND TELEPHONE NUMBER

SIGN HERE:

DA FORM 2028-2
1 JUL 79

PREVIOUS EDITIONS ARE OBSOLETE.

P.S.—IF YOUR OUTFIT WANTS TO KNOW ABOUT YOUR RECOMMENDATION MAKE A CARBON COPY OF THIS AND GIVE IT TO YOUR HEADQUARTERS.

By order of the Secretary of the Army:

BERNARD W. ROGERS
General, United States Army
Chief of Staff

Official:

J.C. PENNINGTON
Brigadier General, United States Army
The Adjutant General

Distribution:

Active Army:

HISA (Ft Monmouth) (26)
USAINSCOM (2)
COE (1)
TSG (1)
USAARENBD (1)
DARCOM (1)
TRADOC (2)
OS Maj Comd (4)
TECOM (2)
USACC (4)
MDW (1)
Armies (2)
Corps
Svc Colleges (1)
USASIGS (5)
USAADS (2)
USAFAS (2)
USAARMS (2)
USAIS (2)
USAES (2)
USAICS (3)

MAAG (1)
USARMIS (1)
USAERDAA (1)
USAERDAW (1)
Fort Gordon (10)
Fort Huachuca (10)
Fort Carson (5)
Army Dep (1) except
 LBAD (14)
 SAAD (30)
toad (14)
 SHAD (3)
Fort Gillem (10)
USA Dep (1)
Sig Sec USA Dep (1)
Ft Richardson (CERCOM Ofc) (2)
Units org under fol TOE:
(2 copies each)
 29-207
 29-610

NG: None

USAR: None

For explanation of abbreviations used, see AR 310-50

